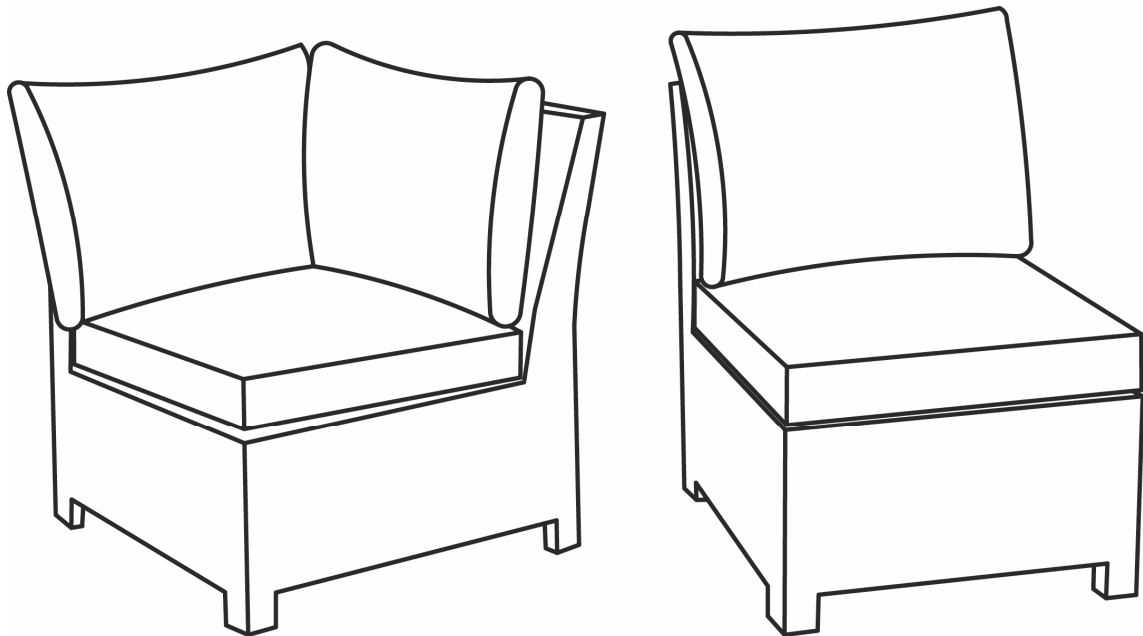

Corner Chair and Middle Chair

Assembly Instructions

Product size:

W81*D81*H82 cm (Corner Chair)

W62*D81*H82 cm (Middle Chair)



This product is for Domestic use only!

IMPORTANT, RETAIN FOR FUTURE REFERENCE

READ CAREFULLY

Corner Chair and Middle Chair

Before you start



Warnings

IMPORTANT, RETAIN FOR FUTURE REFERENCE READ CAREFULLY

See enclosed instructions for assembly, safety and care information.

Failure to follow the warnings could result in serious injury.

Handle heavy parts with care.

Ensure that this product is fully assembled as illustrated before use.

This product should only be used on firm, level ground.

Keep small parts out of reach of children.

Do not stand or climb onto this product.

This product is intended for **domestic use** only.

Furniture can be dangerous if incorrectly used. No liability will be accepted for damage or injury caused by incorrect use of this product.



Dos

When you are ready to start, make sure that you have the right tools, plenty of space and a clean, dry area for assembly.

Remove all packaging and banding and place the components carefully on suitable surfaces to prevent damaging or scratching them.

Check the pack and make sure you have all of the parts listed.

Check all screws and bolts are tightened and inspect regularly.

This product is suitable for all year outdoor use, but we recommend that a furniture cover be used to add additional protection to your product when not in use.

This product is supplied with water proof and stain resistant polyester fabric, unexpected rain ---no problem ---just shake the cushions dry.

Accidental spills of red wine, drinks or sauces--- no problem----just simply wipe off immediately with a damp cloth.

As small animals may consider your cushions a cosy sleeping place we do not recommend they are left out overnight.

Due to the stain resistant nature of these cushions they should require minimal cleaning, please do not bleach, do not tumble dry,

do not iron or dry clean.
Clean with a damp cloth.

X Don'ts

Do not use scourers, abrasives, washing powders, chemical cleaners or any other substances containing abrasives since these substances can damage the product.

Never tilt the chair during use.

Do not use power tools to construct this product.

Do not use this product if parts are missing, damaged or worn.

Do not stand or climb onto the product and do not use it as a ladder, as this could lead to it unbalancing and overturning.

Never drag furniture when moving it, always lift it.

Number of people required for assembly

One Person



Time to assemble



Assembly is not required

Tools required

No need of tools

Corner Chair and Middle Chair

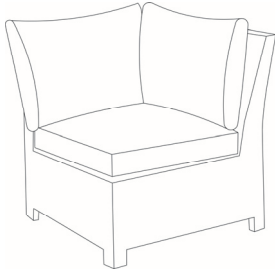
Parts List

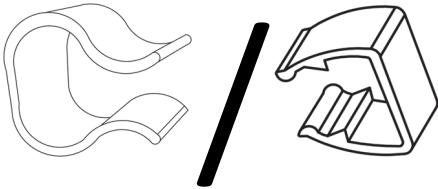
Combination Part No.	Diagram	Name	Qty
1		Corner Chair	1 PC
2		Middle Chair	1 PC
CL	 Diagram for reference only	Clips	6 PCS

Note: Clips are used to combine with other components.
The use method is as per below.

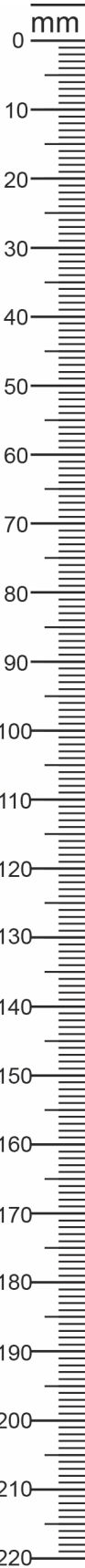

Corner Chair and Middle Chair

Place the sofa at the intended place of use.

In order to better use your seat/sofa, we suggest you connect the Sofa Parts by clips provided.

Attach the clips to two adjacent bottom walls.

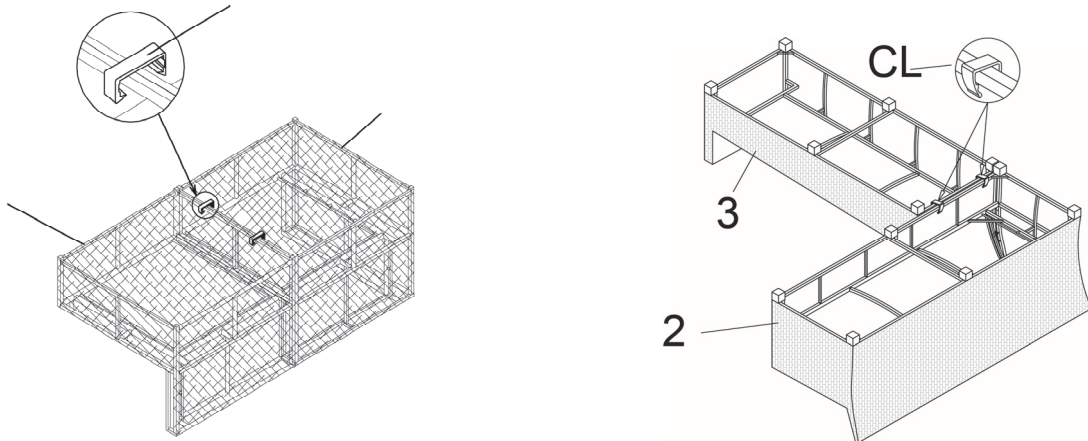

Note: The line-drawing is for assembly guidance only. It may doesn't represent the actual product.

Never tilt the product during use.

Ensure the product is always placed firmly on the ground.

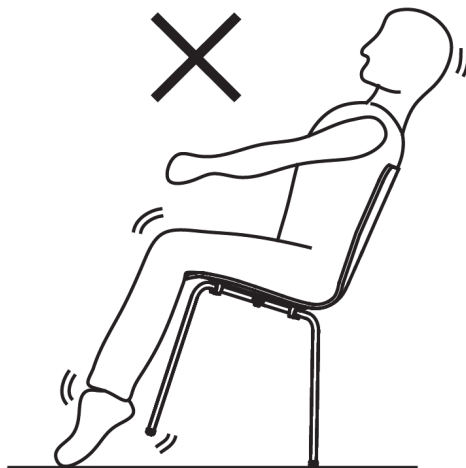

PLEASE KEEP THESE INSTRUCTIONS FOR FUTURE REFERENCE