

ASSEMBLY INSTRUCTIONS

6H 6/6 Panel Headboard

6F 6/6 Footboard

56R Queen/King Rail

Thank you for purchasing this quality product. Be sure to check all packing material carefully for small parts, which may have come loose inside the carton during shipment. Identify and count all parts and compare with the **HARDWARE LIST** below.

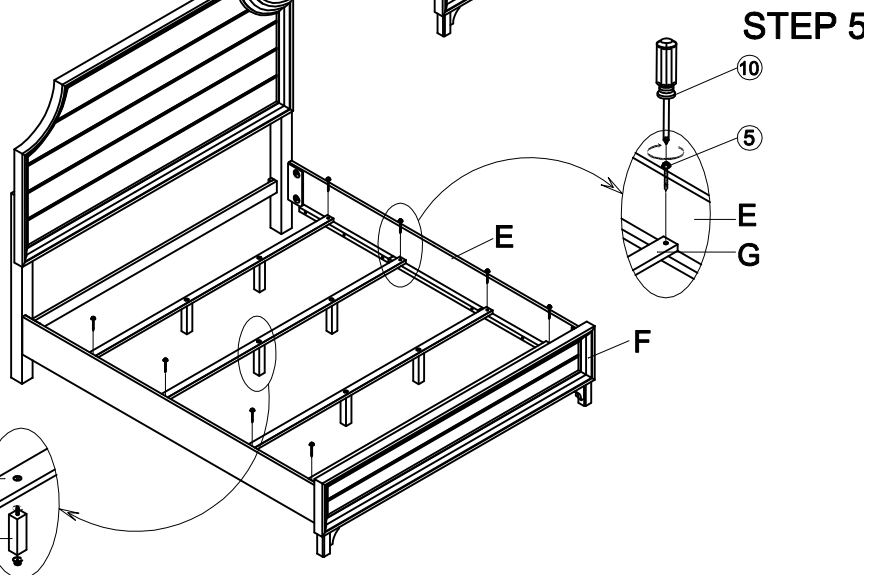
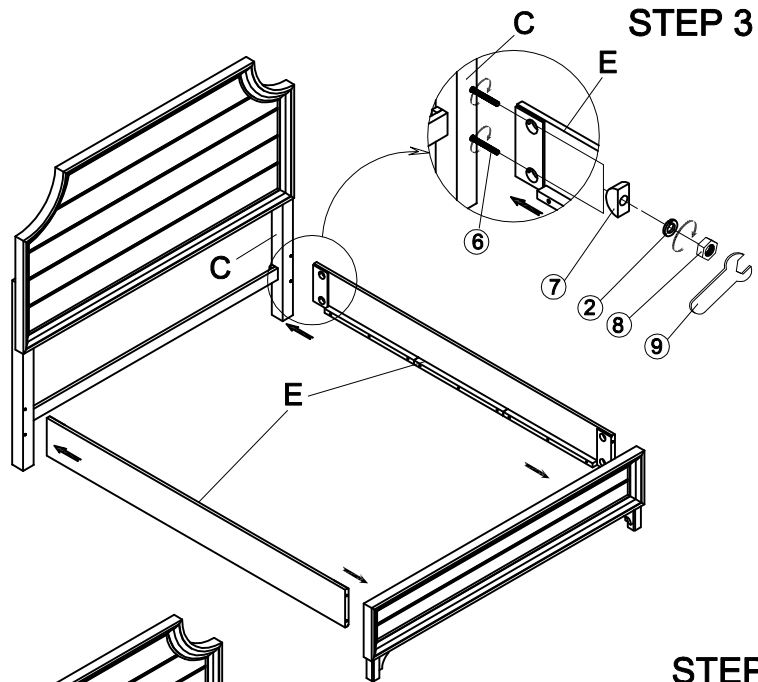

STEP 4

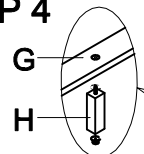

Do not fully tighten all screws and bolts until the entire item is completely assembled.