

Features

- Includes faceplate with handle.
- Single handle controls both on/off activation and temperature settings.
- Supplied with ADA-compliant metal prong handle.
- Integrated push-button diverter.
- Complements Artifacts faucets and accessories.

Material

- Premium material construction with metal handle ensures reliability and durability.
- KOHLER finishes resist corrosion and tarnishing.

Installation

- Trim only; requires valve to complete installation (sold separately).

Required Products/Accessories

K-11748 Series Rite-Temp® Valves

Recommended Products/Accessories

K-23723 Faucet cleaner



ADA

Codes/Standards

ASME A112.18.1/CSA B125.1

ADA







ICC/ANSI A117.1

KOHLER® Faucet Lifetime Limited Warranty

See website for detailed warranty information.

Available Colors/Finishes

Color tiles intended for reference only.

Color	Code	Description
	CP	Polished Chrome
	SN	Vibrant® Polished Nickel
	BN	Vibrant® Brushed Nickel
	BV	Vibrant® Brushed Bronze
	2BZ	Oil-Rubbed Bronze
	2MB	Vibrant® Brushed Moderne Brass

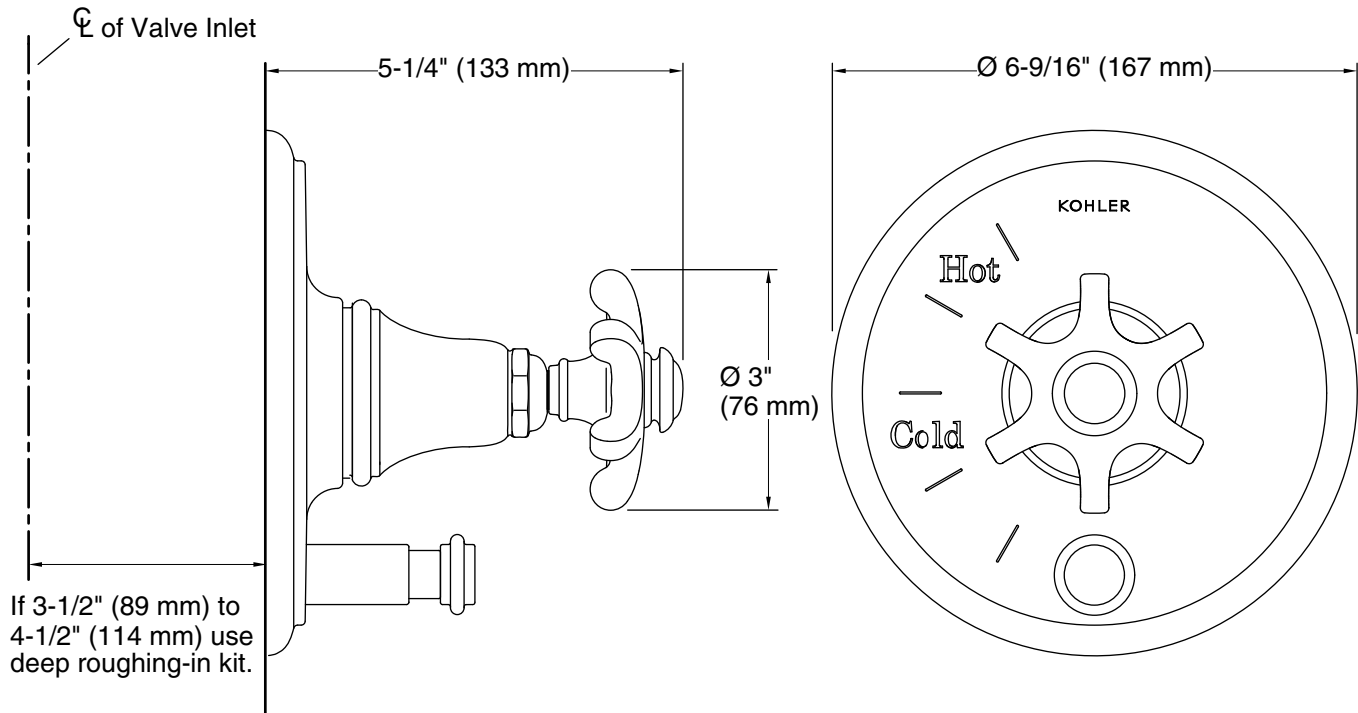

Technical Information

All product dimensions are nominal.

Notes

Install this product according to the installation instructions.

Avoid cross-flow conditions. Do not install shut-off device on either valve outlet.

Install straight pipe or tube drop of 7" (178 mm) to 18" (457 mm) with single elbow between the valve and wall-mount spout.

ADA compliant when installed to the specific requirements of these regulations.