

Office Chair Grey

Assembly Instructions - Please keep for future reference



Dimensions

Width - 63cm

Depth - 53cm

Height - 111/121cm

Important – Please read these instructions fully before starting assembly



Safety and Care Advice

Important – Please read these instructions fully before starting assembly

- Check you have all the components and tools listed on pages 3 and 4.
- Remove all fittings from the plastic bags and separate them into their groups.
- Keep children and animals away from the work area, small parts could choke if swallowed.
- Make sure you have enough space to layout the parts before starting.

- Do not stand or put weight on the product during assembly, this could cause damage.
- Assemble the item as close to its final position (in the same room) as possible.
- Assemble on a soft level surface to avoid damaging the unit or your floor.
- Parts of the assembly will be easier with 2 people.



- We do not recommend the use of power drill/drivers **for inserting screws**, as this could damage the unit. Only use hand screwdrivers.
- Dispose of all packaging carefully and responsibly.

Care and maintenance

- From time to time check that there are no loose screws on this unit.
- This product should not be discarded with household waste. Take to your local authority waste disposal centre.
- To avoid any risk of suffocation to animals or children dispose of the plastic bags immediately .
- As with all surfaces clean with a damp cloth and mild detergent, do not use bleach or abrasive products.

Safety during use

- Do not stand on this chair, Do not use this chair as a step ladder .
- At least every 4 months, check all bolts, screws and knobs, to be sure they are tight .
- Use this product only for seating one person at a time.
- If parts are missing, broken or damaged or worn, stop use of this product until repairs are made & using factory authorized parts .
- Do not use this chair unless all bolts, screws and knobs are firmly secured.
- Failure to follow these warnings could result in serious injury.

Note: if required the next page can be cut out and used as reference throughout the assembly. Keep this page with these instructions for future reference.

Components - Parts

Please check you have all the parts listed below

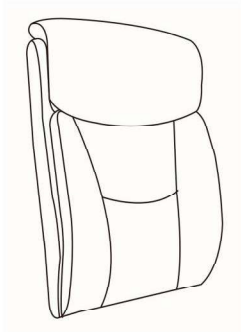

1 Backrest x 1

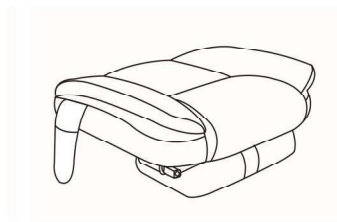

2 Seat x 1

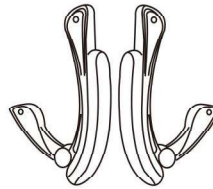

3 Left armrest x 1 &
Right armrest x 1

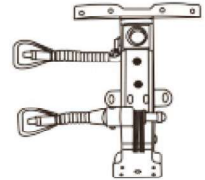

4 Mechanism x 1



5 Gas lift x 1

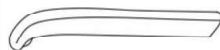

6 Base x 5

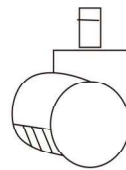

7 Castors x 5



8 Backrest plate x 1

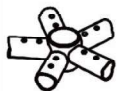

9 Base connector x 1



10 Power adapter x 1







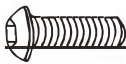

11 Controller x 1

Components - Fittings

Please check you have all the fittings listed below.

Note: The quantities below are the correct amount to complete the assembly.
In some cases more fittings may be supplied than are required.

A  M6x20mm Bolts x10	B  M6x25mm Bolts x 8	C  M8x20mm Bolts x 4	
D  M8x35mm Bolts x4	E  Spring washer x 8	F  Flat washer x 8	G  Plastic cover x4

Tools required



M6 Allen key (supplied)

Ruler - Use this ruler to help correctly identify the screws

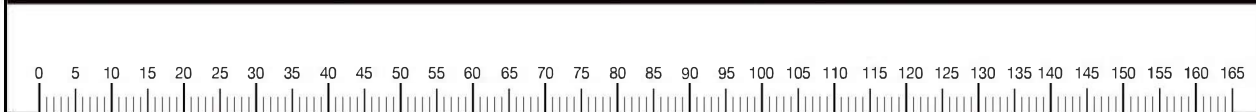

Assembly Instructions

Step 1

Fitting the Base

a: Insert base **(6)** onto connector **(9)**, use bolts **(A)** to fix the base.

NOTE: Ensure all bolts are tight.

b: Push all the five castors **(7)** into the underside of the base.

Insert the gas lift **(5)** into the base **(6)**.

NOTE: Ensure all the castors are firmly located on the base. Ensure the gas lift is fully inserted and well fitted.

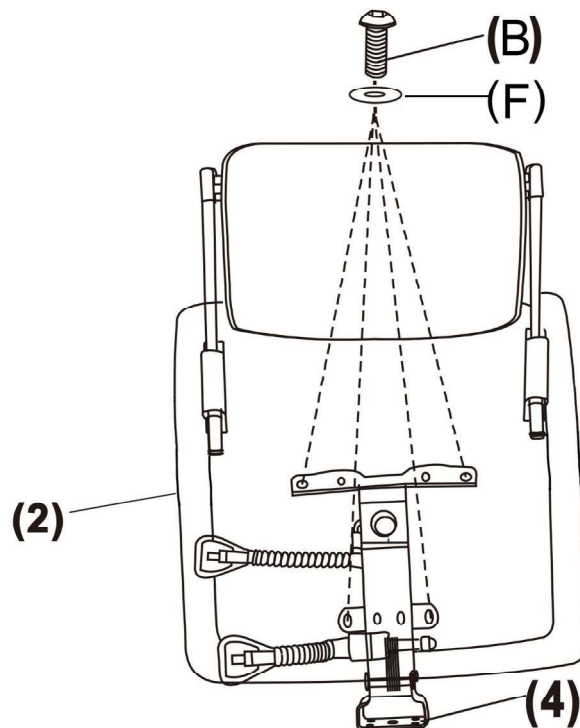
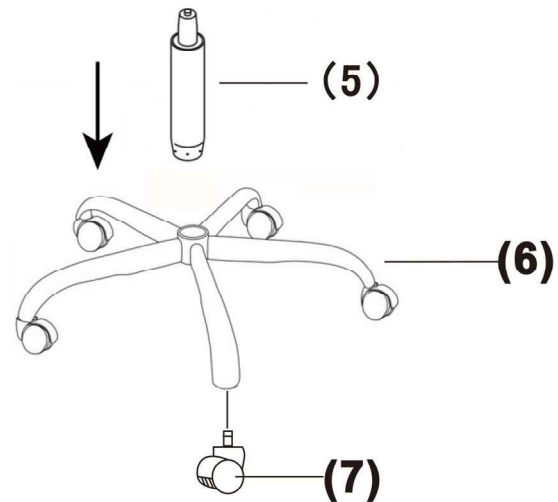
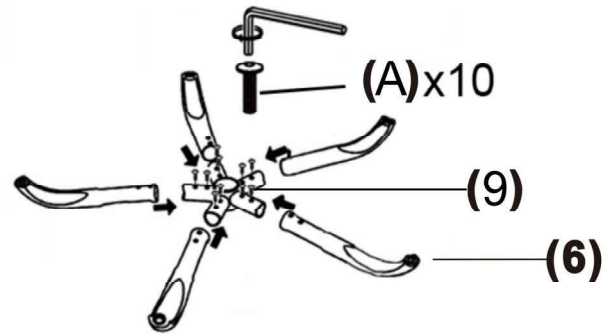

Assembly Instructions

Step 2

Fitting the Backrest

Use bolts **(B)** to fix the plate **(8)** onto the backrest, stick the velcro.

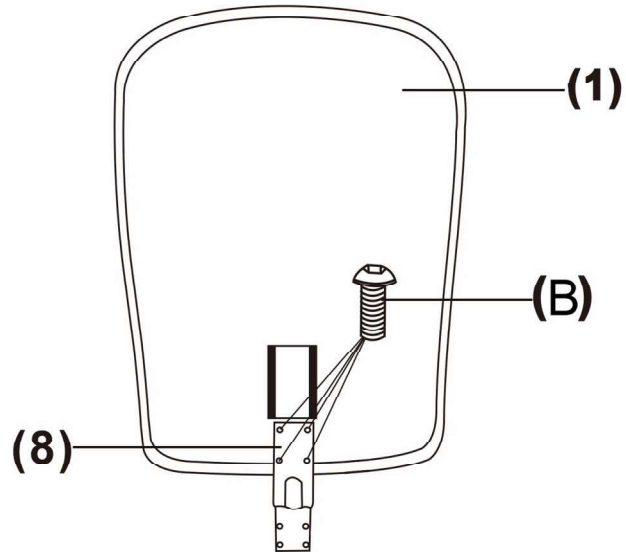

Step 3

Insert **(8)** into the socket of mechanism **(4)**

Use bolts **(C)** across the spring washer **(E)** and flat washer **(F)** to fix the plate into mechanism.

NOTE: It would be useful to ask someone to help you at this stage.

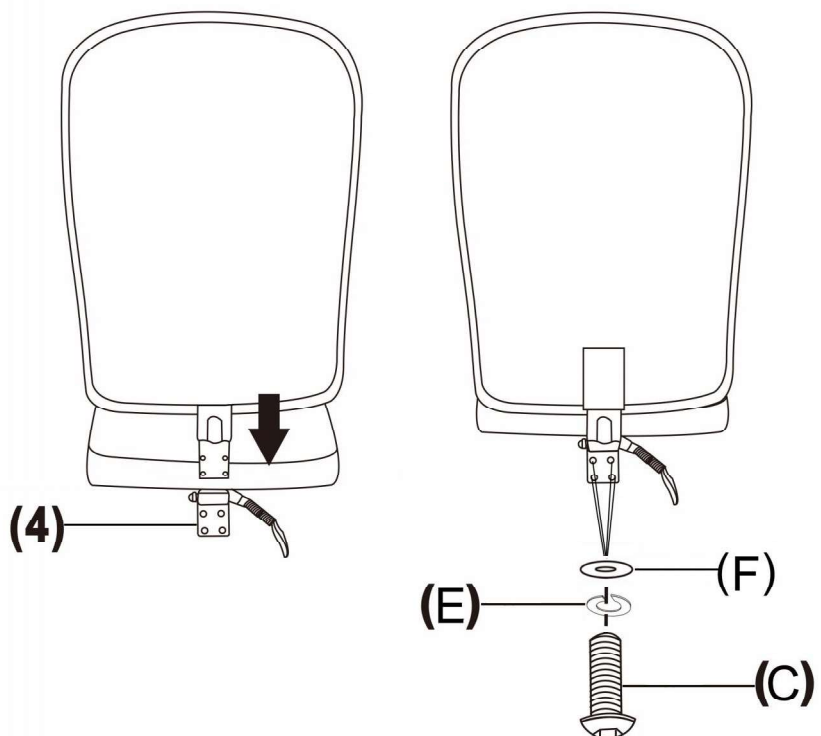

Assembly Instructions

Step 4

Fitting the Armrest

Use the bolts **(D)** across the spring washer **(E)** to fix the armrest **(3)** onto the seat **(2)** and backrest **(1)**, insert cover **(G)** into armrest **(3)** connect power adapter **(10)** with backrest plug, connect controller **(11)** with backrest plug.

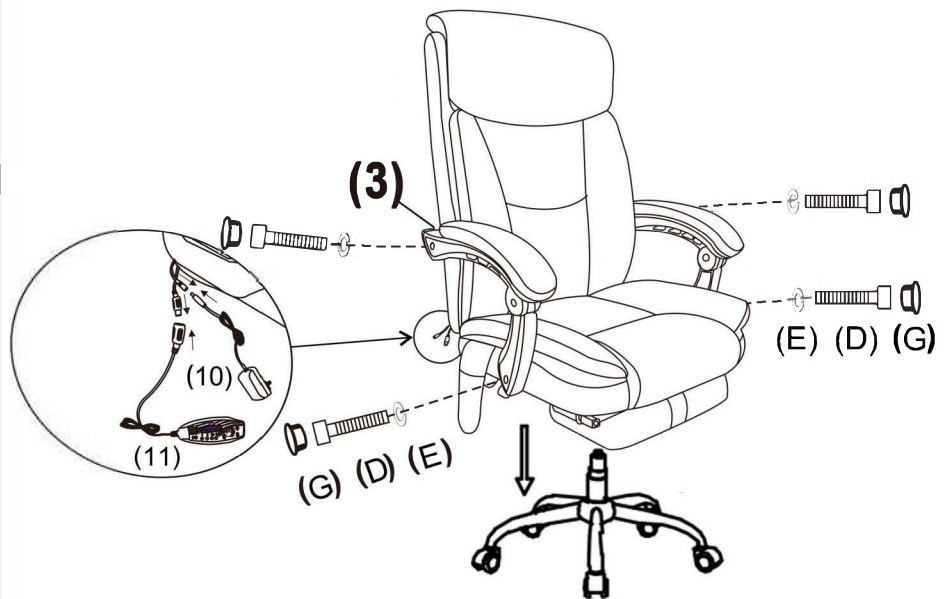

Fitting the Unit

Carefully locate the seat **(2)** onto the base unit.

NOTE: It would be useful to ask someone to help you at this stage.

Step 5

Finishing the Unit

Carefully place the unit in the desired location.

Assembly is complete.

