

# Assembly & Instruction Manual

SKU: A323/A324/A325/A326/A327/A328

# Raised garden bed

## Installation Guide

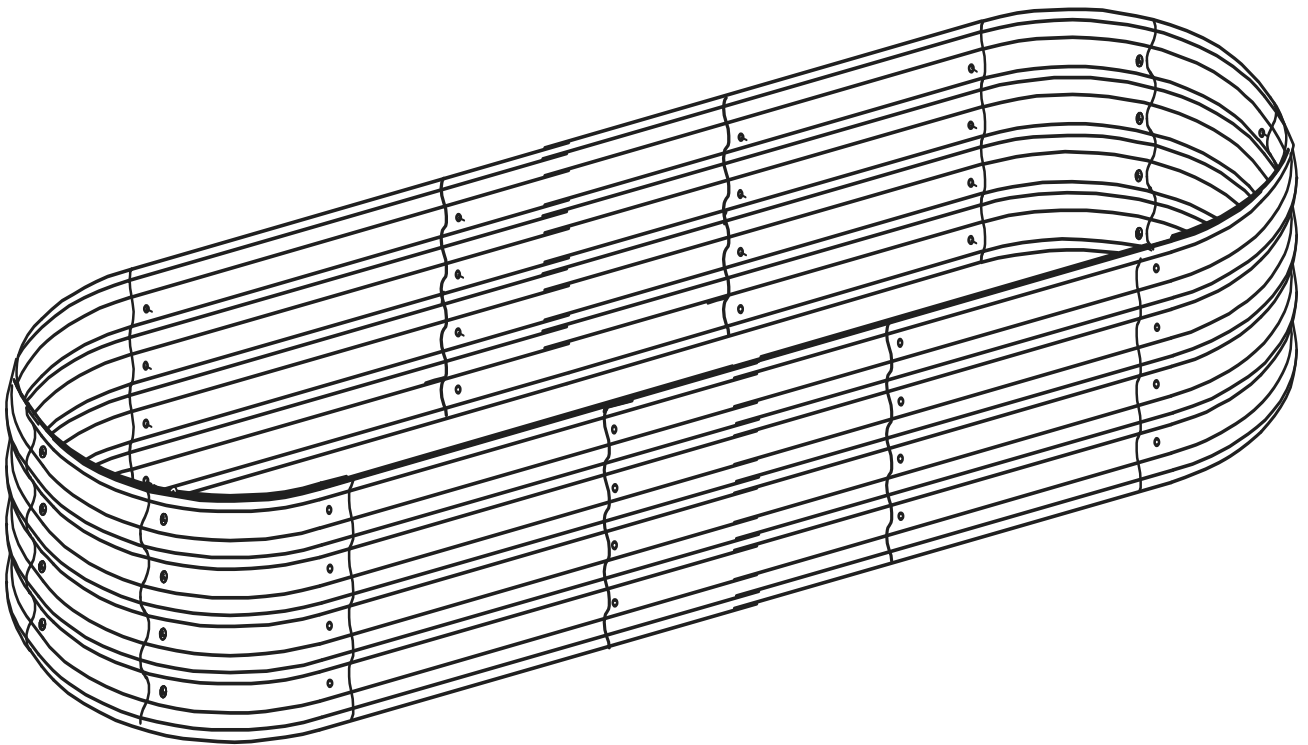

Version: 20241015

Approximate  
assembly time: **15 Minutes**

People  
for assembly:



Save this manual for future reference

# INTRODUCTION

Thank you for purchasing Aoodor's raised garden bed! We hope you will find joy in our product for many years to come.

To ensure your personal safety during installation and to get the most out of your investment, please read this entire manual before beginning the installation process. If you feel that this process is too difficult to do on your own, we advise that you seek assistance from a local building or home improvement contractor.



**WARNING** Improper installation and operation of your gazebo can result in severe personal injury as well as product failure not covered by warranty. Please follow all instructions carefully or contact technical support for assistance.

We believe that installation can be a simple, streamlined process if you follow the instructions in this manual. Please contact our customer support line for help any step of the way. If you need assistance with assembly, have missing or defective parts, or any other issues, please email us at [customerservice@aoodor.com](mailto:customerservice@aoodor.com)



## **SAFETY INFORMATION**

Please read and understand this entire manual before attempting.

## **PREPARTION**

Before beginning assembly of product, make sure all parts are present. Compare parts with package contents list and hardware contents list. If any part is missing or damaged, do not attempt to assemble the product.

# Parts Listing

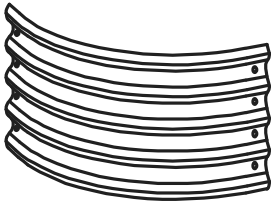
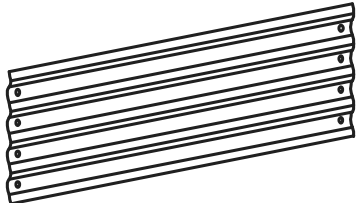
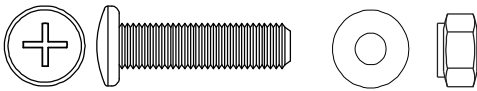
Parts	Desc	Qty	Ref No
A	 End panel	6	A323-001
		12	A324-001
		6	A325-001
		12	A326-001
		6	A327-001
		6	A328-001
B	 Side panel	4	A323-002
		8	A324-002
		2	A325-002
		4	A326-002
		6	A327-002
		8	A328-002
C	 Screw,Nut and Washer	40	A323-003
		40x2	A324-003
		32	A325-003
		32x2	A326-003
		48	A327-003
		56	A328-003

# Assembly

## 1 Step One

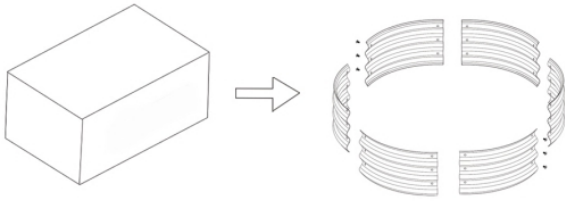

Remove protective films from all panels, and lay panels on a flat surface according to the above configuration

## 2 Step Two

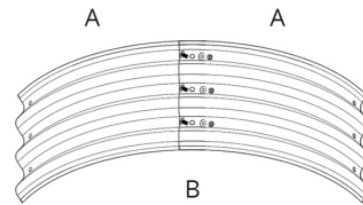

Assemble all curved panels : initially attach all bolts , washers and nuts loosely , and then tighten upusing the wrench tool ( as supplied ) with a screwdriver / cordless drill

## 3 Step Three

Inside



Outside

Make sure to tighten each nut and bolt for reinforcement of garden raised bed.

## 4 Step Five

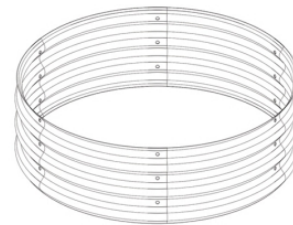

Congratulations on completing the assembly !  
Now you can start to build your dream garden .

## ✓ Enjoy



# Assembly

---

8-in-1 raised bed configuration options:

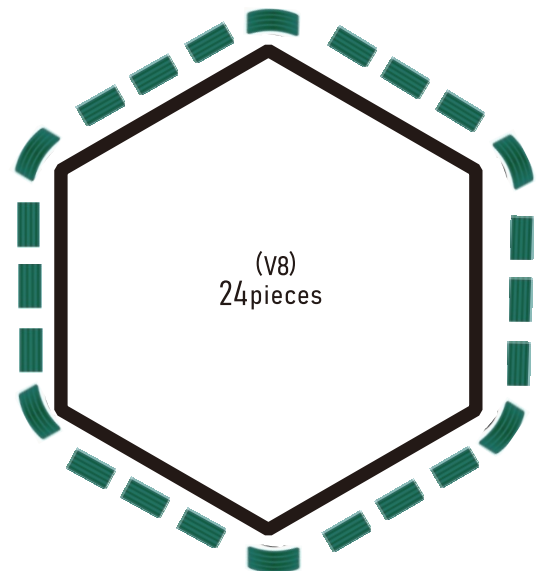
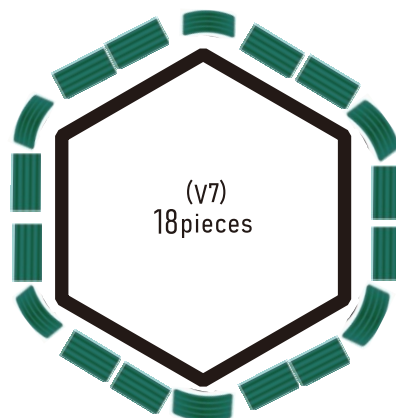
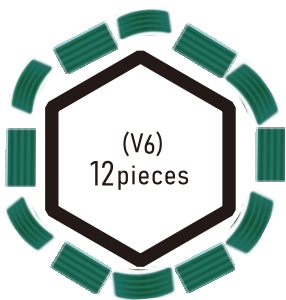
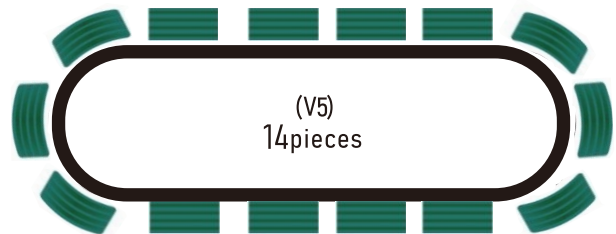
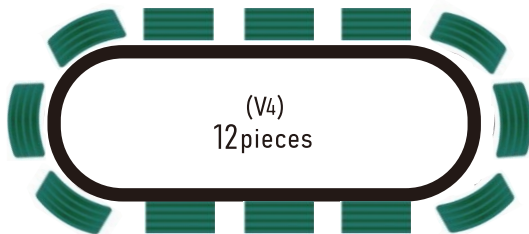
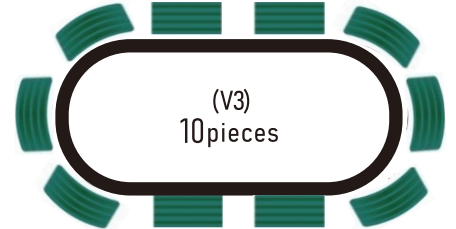
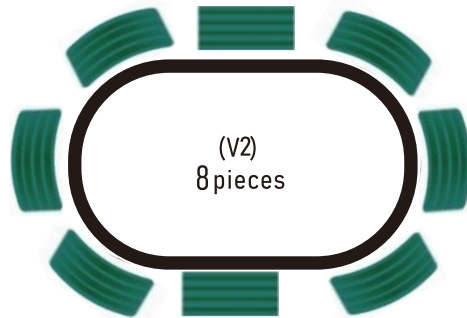
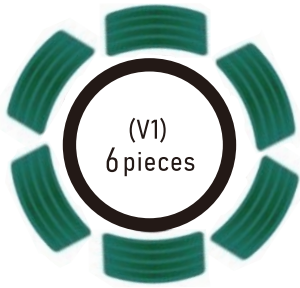

Please don't hesitate to contact us for any further questions,  
your satisfaction is guaranteed.  
[support@aodorshop.com](mailto:support@aodorshop.com)  
<https://aodorshop.com/>