

Top View

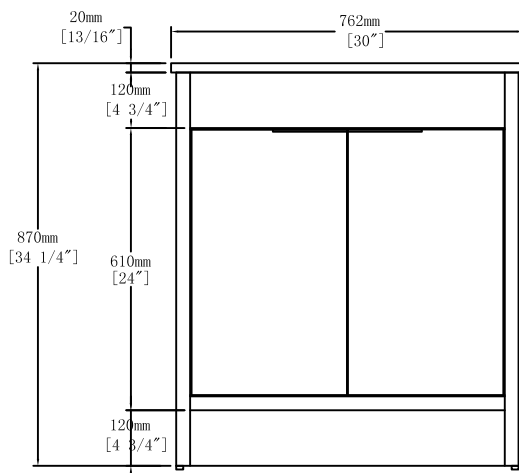

Front View

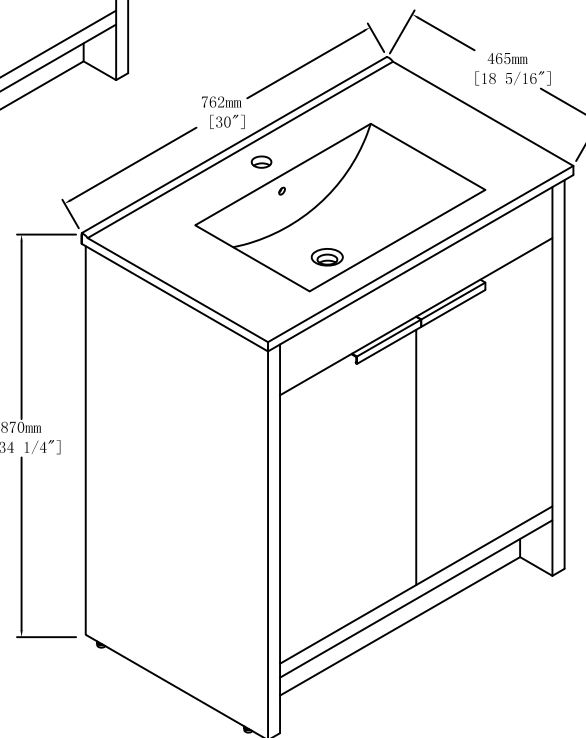
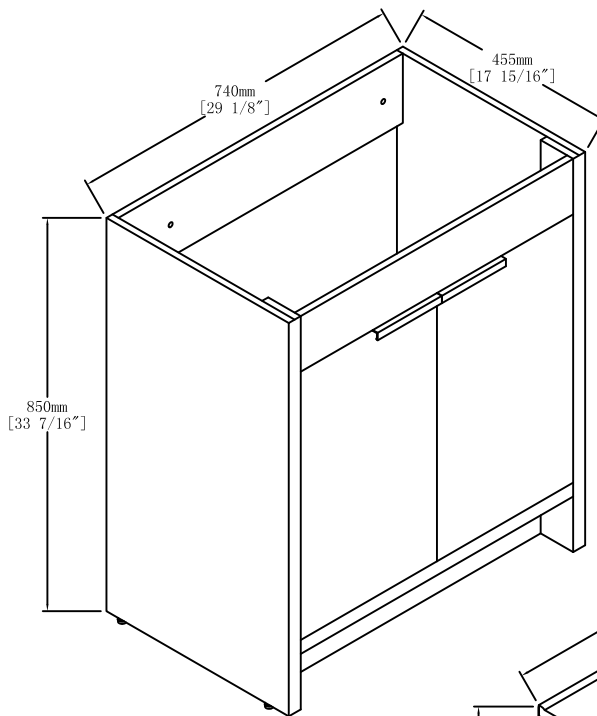
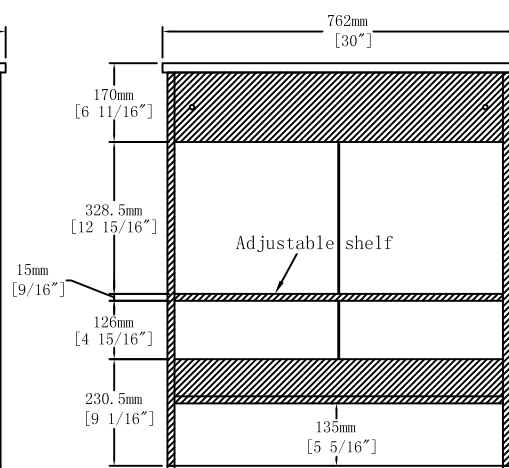

Back View

Item NO.

BV B02430

Version

V1

Projece

Date

2022-8-9