

ASSEMBLY INSTRUCTION

WF300705

WF300707

WF300708

WF300709

Friendly Reminder:

- 1.This sofa is packed in 4 boxes. Please assemble it After all boxes are received.
- 2.As the cushions are all vacuum compressed,there will be some wrinkles.
Please give your cushions up to 72 hours to reach its original size and the wrinkles will basically disappear.
- 3.Please do not open the compressed packags until your sofa frame is completely assembled.

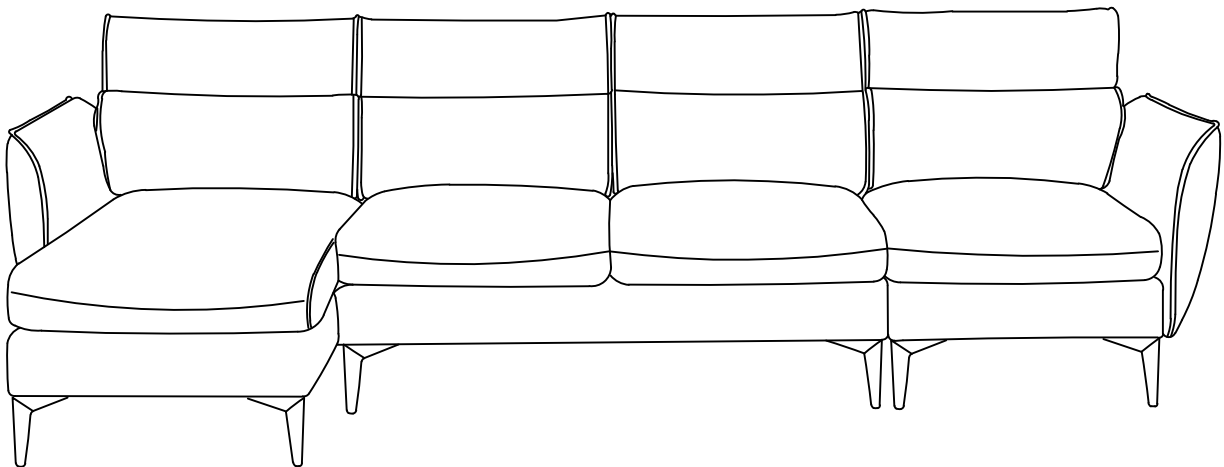





Return & Warranty policy:



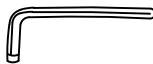

- We strive to offer the highest quality products,and we also try our best to satisfy each and every customer that orders from us with replacement parts or service as needed.
- If the item is damaged or defective, please take photos as evidence for replacements and refunds.
- Please do not return to store,contact the seller if you have any troubles with this product.

ASSEMBLY INSTRUCTION

HARDWARE

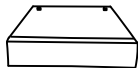

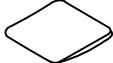
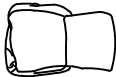
NO	DESCRIPTION	SKETCH	QTY
1	Washer		28
2	Screws 8X18		24
3	Screws 8X80		4
4	Screws 8X60		20
5	Butterfly Nut		4
6	Wrench		1

PARTS LIST WF300705





NO	DESCRIPTION	SKETCH	QTY
C	Chair Frame		1
D	Chair Backrest		1
G	Cushion		1
H	Cushion Cover		1
K	Back Cushion		1
O	Leg		4

ASSEMBLY INSTRUCTION

PARTS LIST WF300707

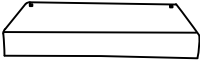
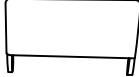
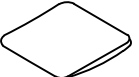
NO	DESCRIPTION	SKETCH	QTY
M	Armrest (Left)		1
N	Armrest (Right)		1

PARTS LIST WF300708

NO	DESCRIPTION	SKETCH	QTY
B	Love Seat Frame		1
E	Love Seat Backrest		1
G	Love Seat Cushion		2
H	Cushion Cover		2
K	Back Cushion		2
O	Leg		4

ASSEMBLY INSTRUCTION

PARTS LIST WF300709







NO	DESCRIPTION	SKETCH	QTY
A	Chaise Frame		1
F	Chaise Backrest		1
I	Chaise Cushion		1
J	Chaise Cushion Cover		1
K	Back Cushion		1
L	Back cover		1
O	Leg		4

DIAGRAM 1

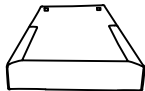
Tack the Love Seat Backrest(Parts D)Cushion Cover(Parts H)Back Cushion (Parts K)Leg(Parts O)out of the Love Seat Frame(Parts C).

Tack the Love Seat Backrest(Parts E)Cushion Cover(Parts H)Back Cushion (Parts K)Leg(Parts O)out of the Love Seat Frame(Parts B).

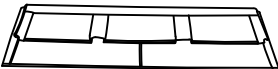
Tack the Chaise Backrest(Parts F)Chaise Cushion Cover (Parts J)Back Cushion (Parts K)Back cover(Parts L) Leg(Parts O)out of the Love Seat Frame(Parts A).

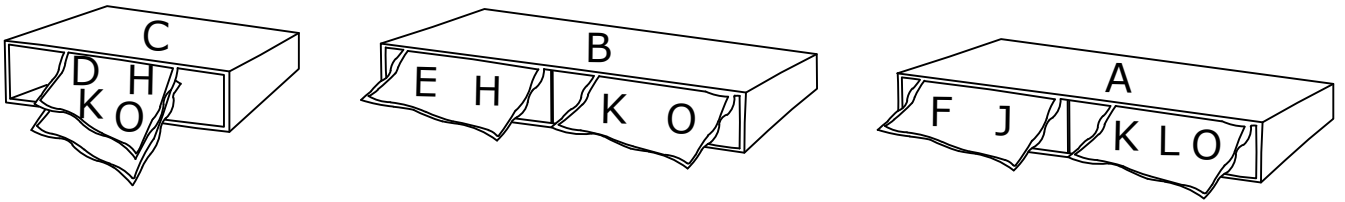

DIAGRAM 2

All parts and hardware.

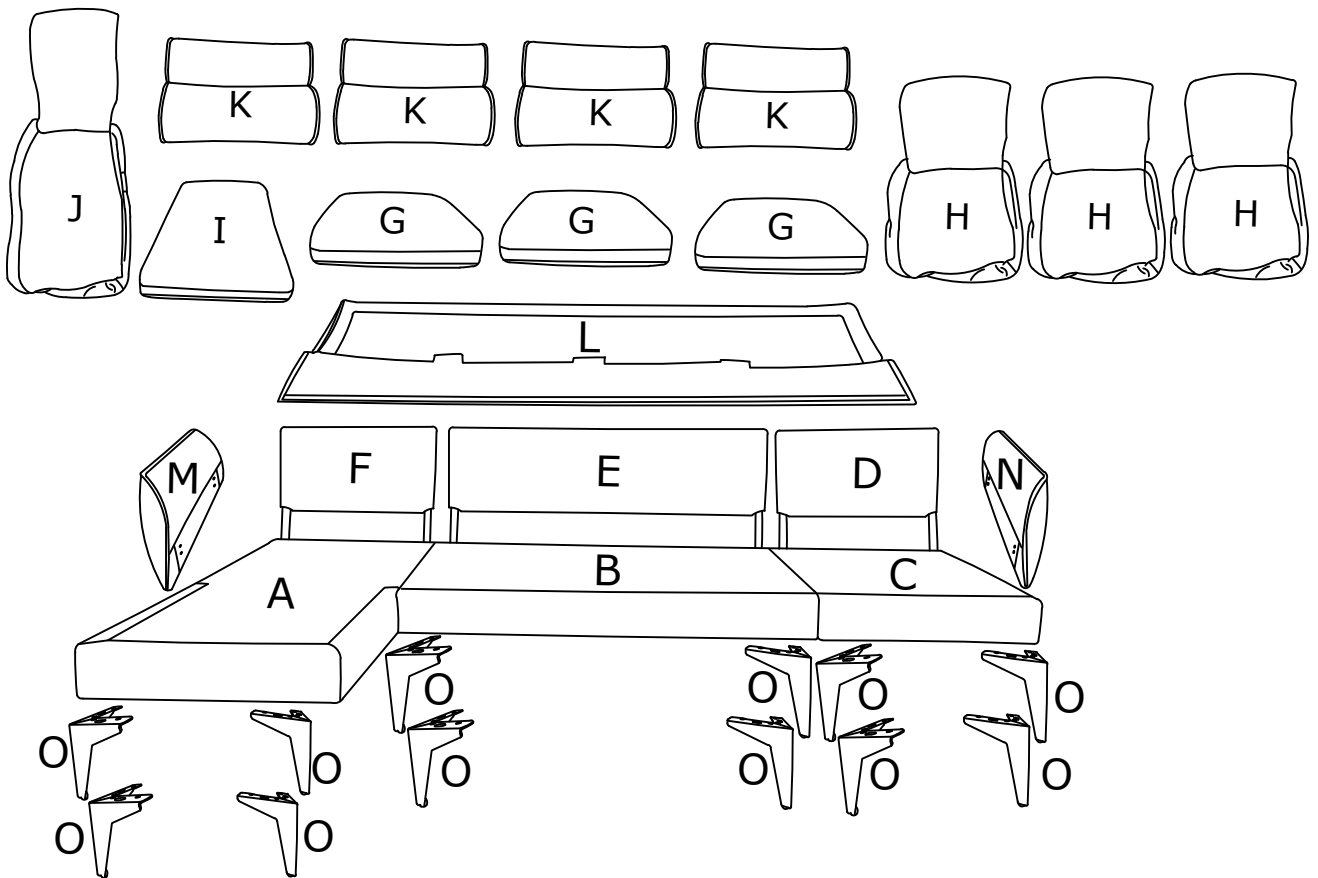
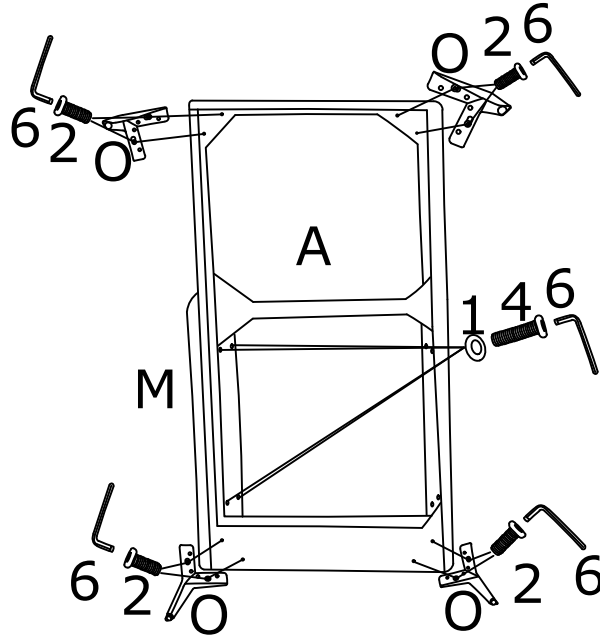

DIAGRAM 3

Tighten 4 legs (Parts O) by screws(Hardware 2) using the wrench(Hardware 6).
 Connect the armrest (Parts M)with the Chaise Frame(Parts A)tighten the washer (Hardware 1)screws(Hardware 4)by wrench(Hardware 6).







1		4PCS
2	 M8X18	8PCS
4	 M8X60	4PCS
O		4PCS

DIAGRAM 4

Tighten 4 legs (Parts O) by screws(Hardware 2) using the wrench(Hardware 6).



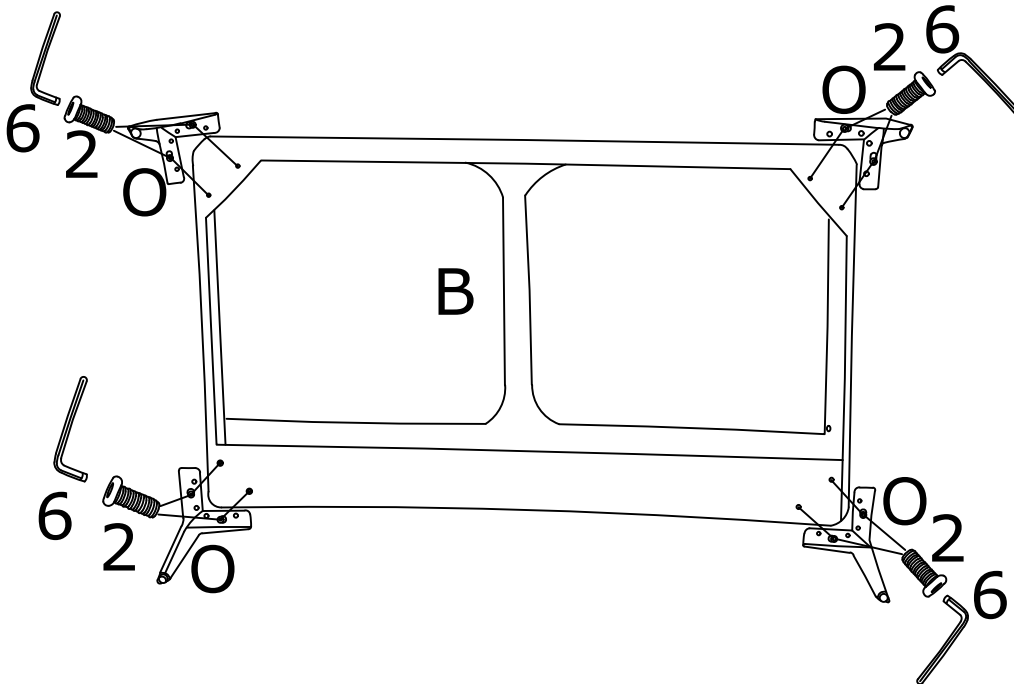

2	 M8X18	8PCS
O		4PCS

DIAGRAM 5

Tighten 4 legs (Parts O) by screws(Hardware 2) using the wrench(Hardware 6).
 Connect the armrest (Parts N)with the Love Seat Frame (Parts C)tighten the washer(Hardware 1)screws(Hardware 4)by wrench (Hardware 6).





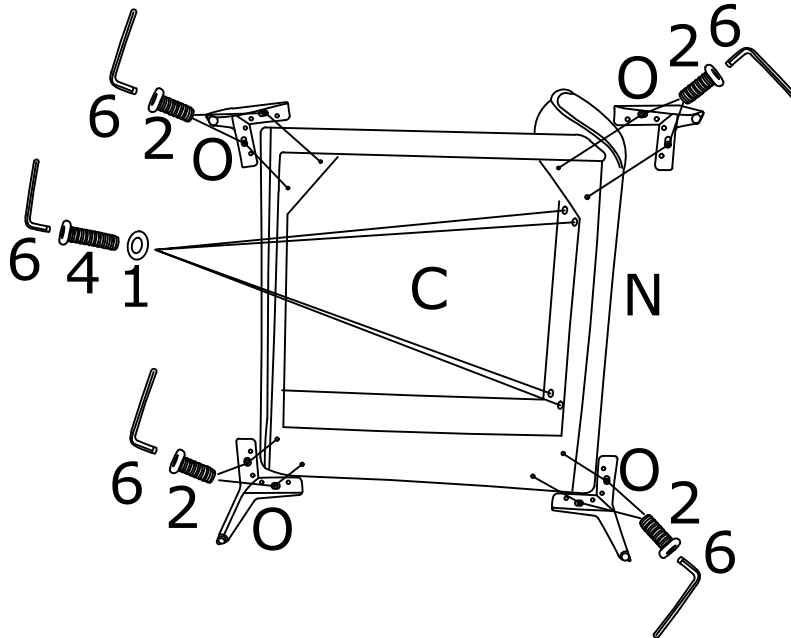

1		4PCS
2	 M8X18	8PCS
4	 M8X60	4PCS
O		4PCS

DIAGRAM 6

Connect the love seat sofa with the couch sofa tighten the screws(Hardware 3) with the butterfly nuts(Hardware 5)washer(Hardware 1)by wrench(Hardware 6).





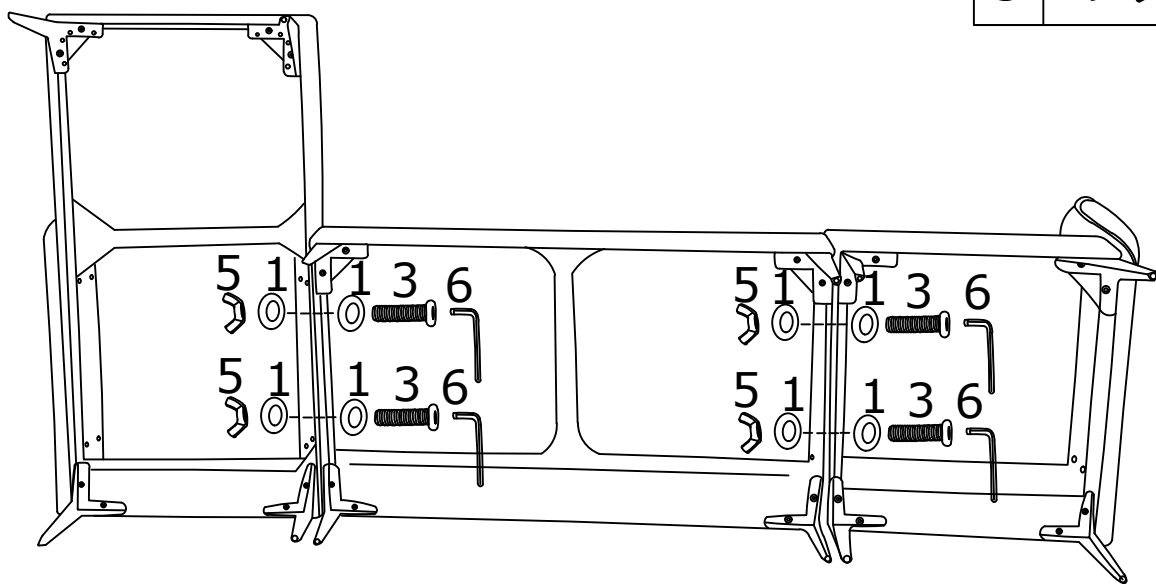

1		8PCS
3	 M8X80	4PCS
5		4PCS

DIAGRAM 7

Connect the Love Seat Backrest(Parts D) and Love Seat Backrest (Parts E) and Chaise Backrest(Parts F)tighten the Screws (Hardware 4)with tighten the washer(Hardware 1)by wrench(Hardware 6).

Please install the top screws first, and then install the next screws.

Don't tighten any screws before you ensure all the screws are put in the holes.

1		6PCS
4	 M8X60	6PCS

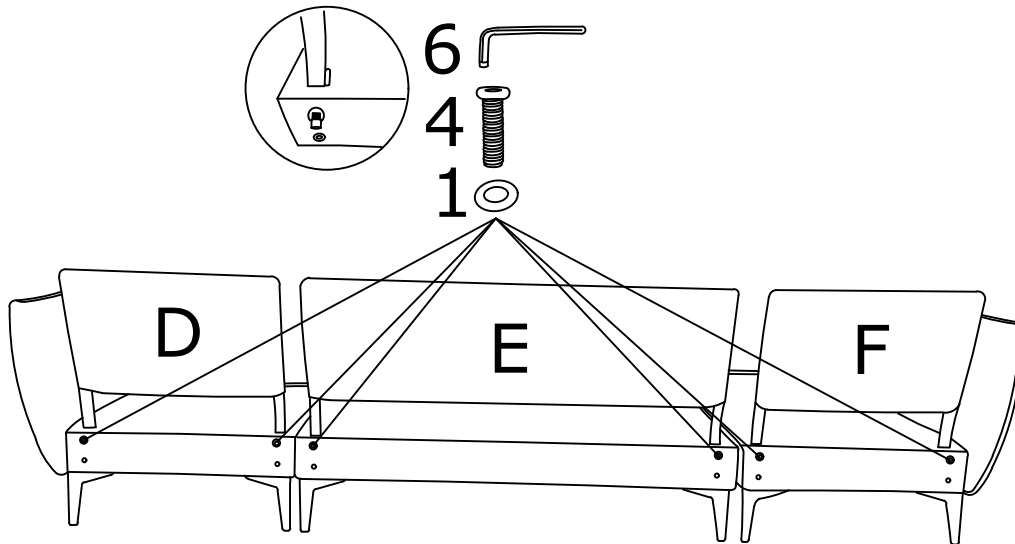



DIAGRAM 8

Connect the Love Seat Backrest(Parts D) and Love Seat Backrest (Parts E)and Chaise Backrest(Parts F)tighten the Screws(Hardware 4)with tighten the washer(Hardware 1)by wrench (Hardware 6).

1		6PCS
4	 M8X60	6PCS

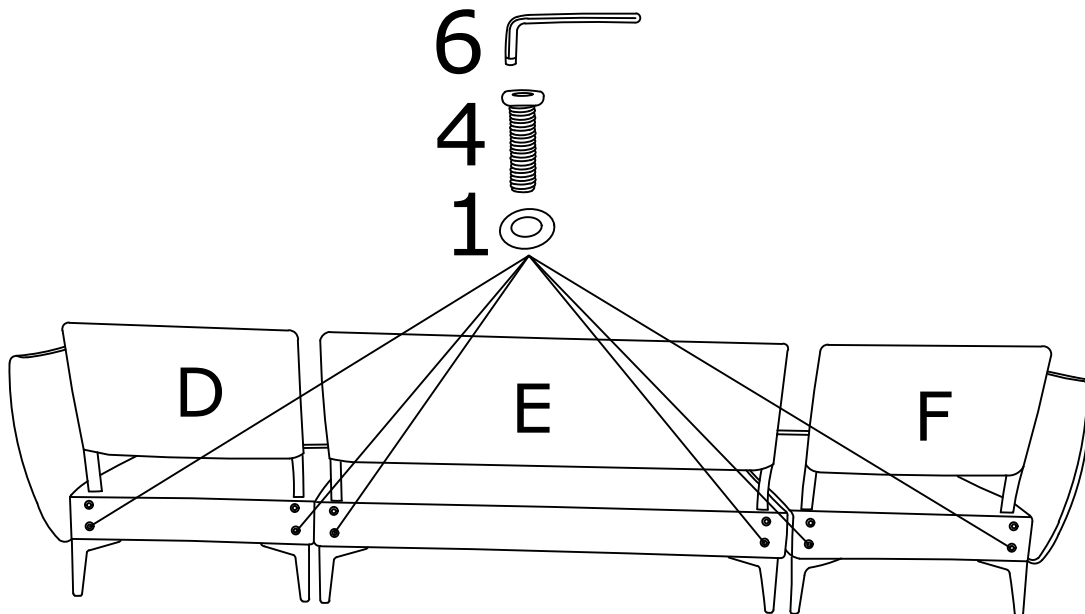

DIAGRAM 9

Place the back cover (Parts L) over the backrest (Parts D \ Parts E \ Parts F).

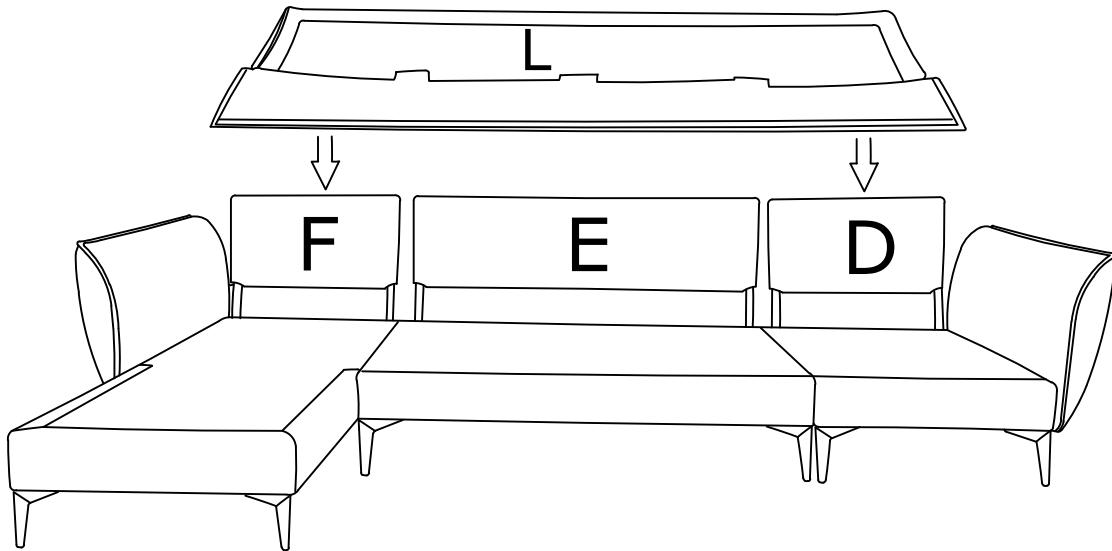
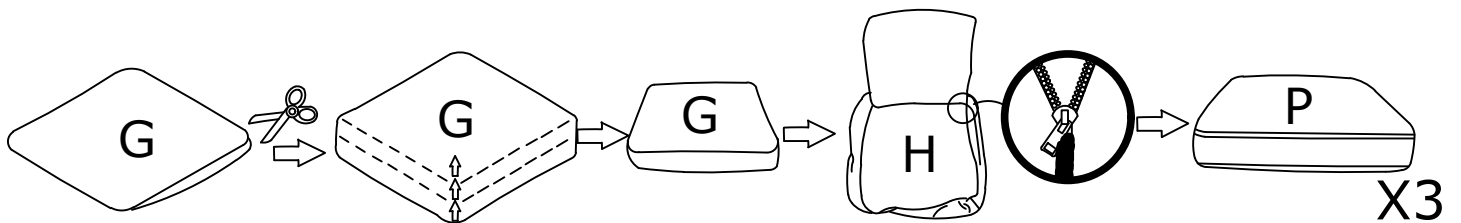

DIAGRAM 10

Remove the plastic bags (Parts G) of Love Seat Cushion and Chaise Cushion (Parts I).

Please align the chain first and then pinch the zipper gently and close it smoothly.



Stuffing Love Seat Cushion (Parts G) into Cushion Cover (Parts H) and zip it up.

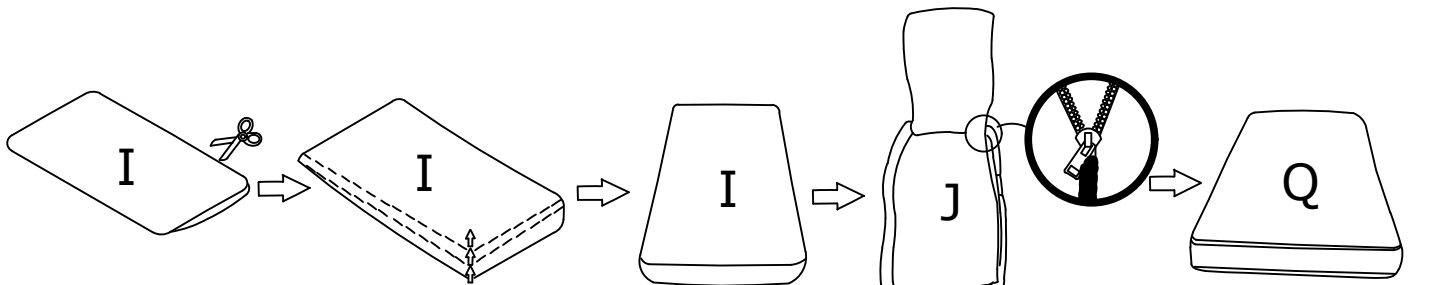

Stuffing Chaise Cushion (Parts I) into Chaise Cover (Parts J) and zip it up.

DIAGRAM 11

Remove the plastic bags(Parts K) of Back Cushion.

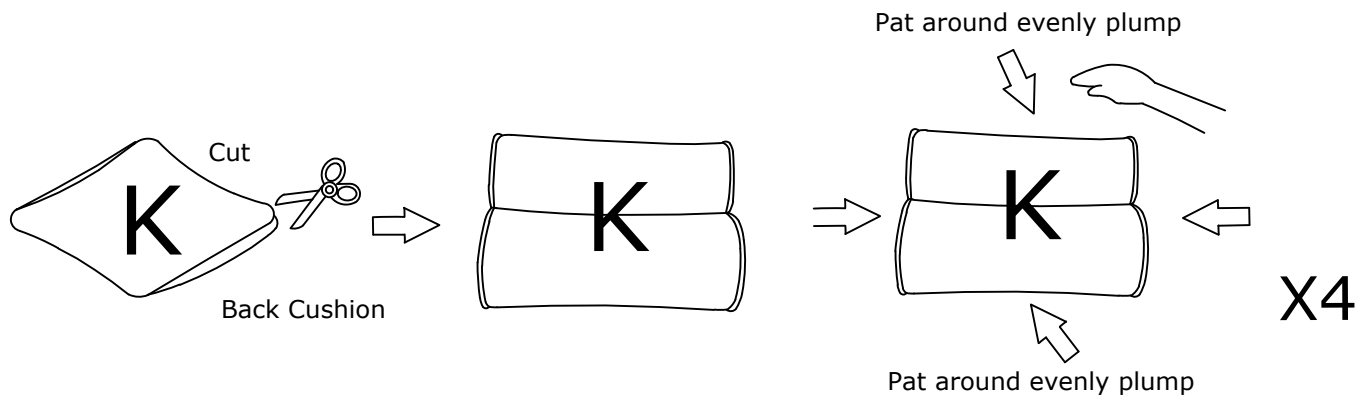

TIPS :

1. Please do not open the compressed packages until your sofa frame is completely assembled.
2. Compressed back cushions and pillows need to be fully fulfilled within 72 hours for your perfect use.
3. Please keep children away from plastic bags or any small pieces of stuff.

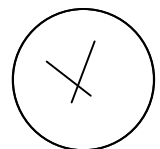
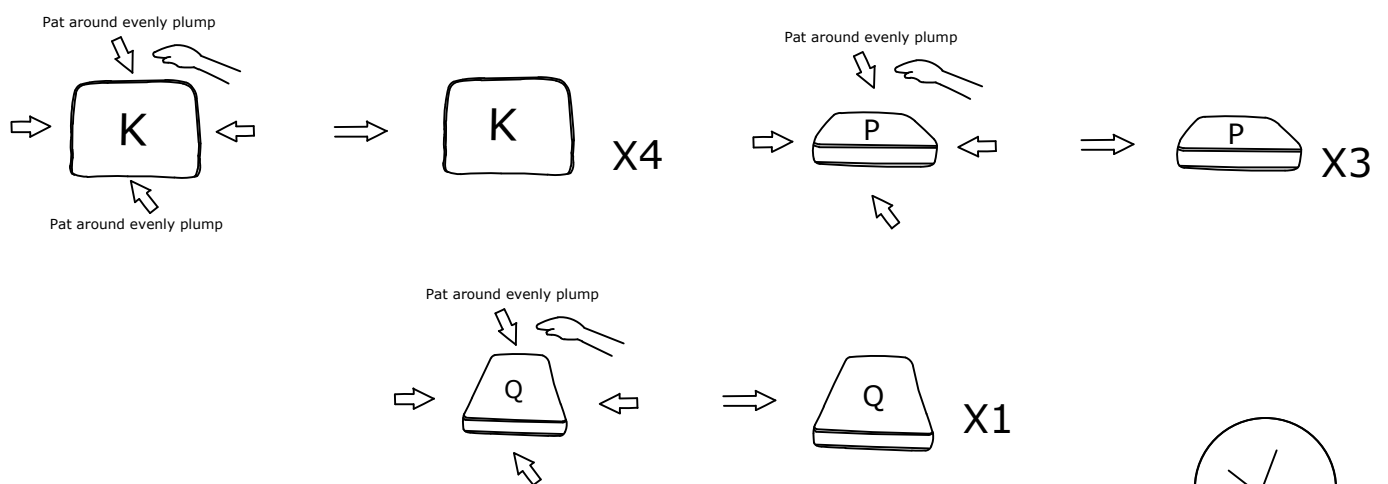

72h

DIAGRAM 12

Put the love seat cushions (Parts P) and Chaise Cushion (Parts Q), the back cushions (Parts K) on the sofa. Recheck all the bolts before you sit on the sofa.

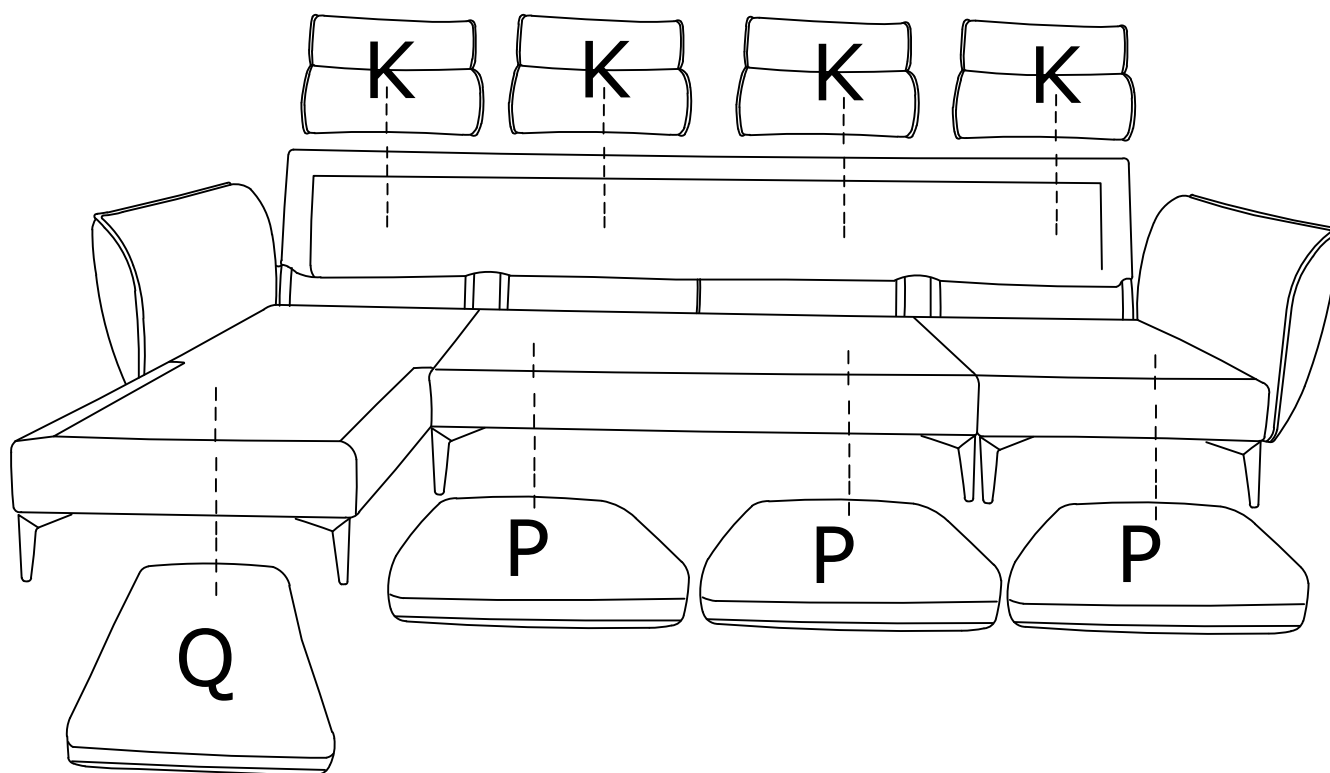

TIPS :

1. Please do not open the compressed packages until your sofa frame is completely assembled.
2. Compressed back cushions and pillows need to be fully fulfilled within 72 hours for your perfect use.
3. Please keep children away from plastic bags or any small pieces of stuff.

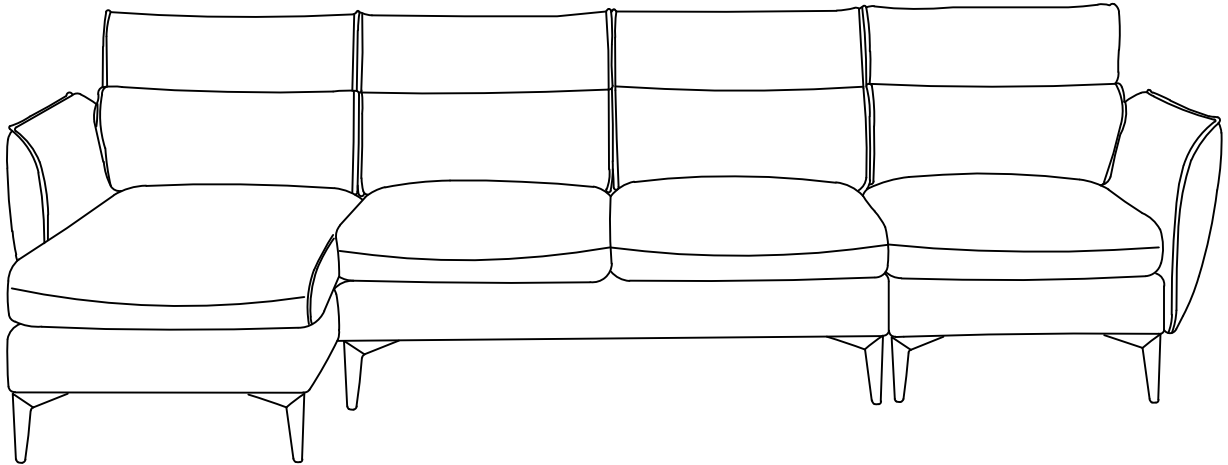

OR

