

# SFU6300TVX



Category	24"
Product family	Oven
Power supply	Electrical
Cooking method	Thermo-ventilated
Cleaning system	VaporClean
EAN code	8017709284831



## Aesthetic

Aesthetics	Classic	Stainless steel type	Brushed
Color	Stainless steel	Silkscreen color	Black
Finishing	Fingerprint-proof	Silkscreen type	Symbols
Design	Flat	Handle color	Stainless steel
Material	Stainless steel	Logo	Embossed

## Controls











Display name	DigiScreen	Display technology	LED
--------------	------------	--------------------	-----

## Programs / Functions

No. of cooking functions 8

Traditional cooking functions

 Static	 Fan-assisted	 True European convection
 Turbo	 Eco	 Large grill
 Fan grill (large)	 Bottom	

Other functions

 Defrost by time
--

## Cleaning functions

 Vapor Clean

## Options



<b>Time-setting options</b>	Delayed start and automatic shut-off when cooking ends	<b>Timer</b>	1
<b>Minute minder</b>	Yes	<b>Rapid pre-heating</b>	Yes

## Technical Features



<b>Minimum Temperature</b>	122 °F	<b>Grill element - power</b>	1700 W
<b>Maximum temperature</b>	482 °F	<b>Large grill - Power</b>	2700 W
<b>No. of shelves</b>	5	<b>Circular heating element - Power</b>	1550 W
<b>Fan</b>	Single	<b>Heating elements stop when door is opened</b>	Yes
<b>No. of lights</b>	2	<b>Door</b>	Cool-touch door
<b>Lighting</b>	Halogen	<b>Removable inner door</b>	Yes
<b>Replaceable light</b>	Yes	<b>Total no. of door glasses</b>	3
<b>Light power</b>	40 W	<b>Cooling system</b>	Tangential
<b>Light on when door is open</b>	Yes	<b>Cooling duct</b>	Double
<b>Lower heating element power</b>	1200 W	<b>Cooling System Speed Reduction</b>	Yes
<b>Upper heating element - Power</b>	1000 W	<b>Cavity material</b>	EverClean enamel

## Performance / Energy Label



**Volume of the cavity** 2.54 cu. ft.

## Accessories Included

<b>Rack with back stop</b>	1	<b>Insert grid</b>	1
<b>Enameled 1.6"-deep tray</b>	1		

## Electrical Connection

<b>Voltage</b>	230 V	<b>Current</b>	13 A
<b>Nominal power</b>	3400 W	<b>Frequency</b>	60 Hz
		<b>Power cord length</b>	45 1/4 "

Voltage

120/208 V

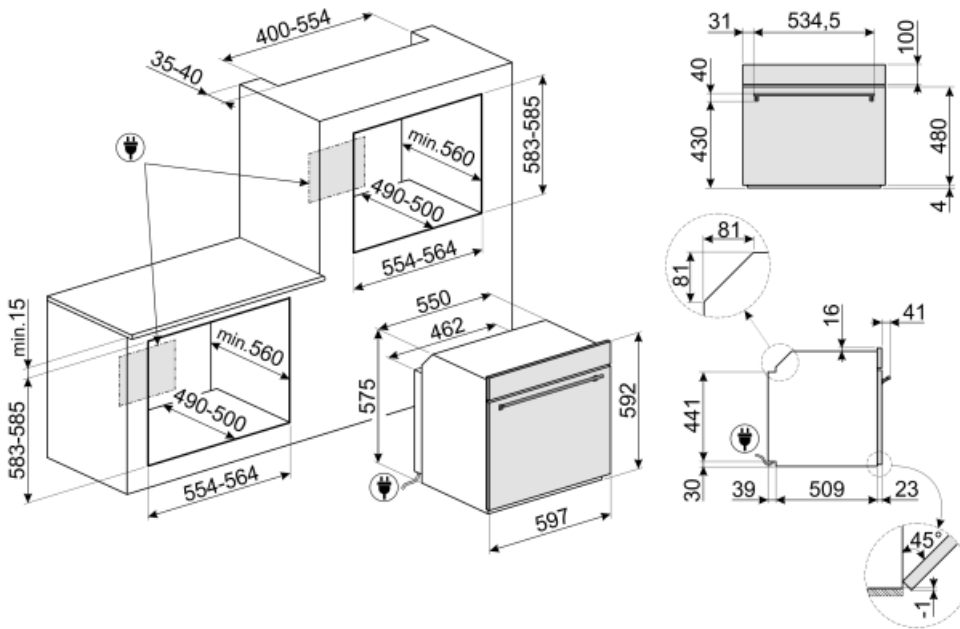

---

## Not included accessories

---

### GTP

**\*\*Partial-extension telescopic guides\*\***  
Length: 14" Extraction: 11 1/4" Material:  
Stainless steel AISI 430 polished



### PRTX

Refractory pizza stone with handles.  
D=35cm Not suitable for microwave  
ovens. Suitable for gas ovens, to be put  
on the griddle.



### PALPZ

Pizza shovel with fold away handle  
width: 315mm length : 325mm



### BN640

Enamelled tray, 40mm deep



### PR3845X

Antifingerprint stainless steel. Cover  
for furniture in column installation of  
more ovens



### BN620-1

Enamelled tray, 20mm deep























### GTT

**\*\*Total-extension telescopic guides\*\***  
Length: 14" Extraction: 16.5" Material:  
Stainless steel AISI 430 polished



## Symbols glossary (TT)

 <p>Air cooling system: to ensure a safe surface temperatures.</p>	 <p>Defrost by time: with this function the time of thawing of foods are determined automatically.</p>
 <p>...</p>	 <p>Triple glazed doors: Number of glazed doors.</p>
 <p>Electric</p>	 <p>Enamel interior: The enamel interior of all Smeg ovens have a special antacid lining which helps keep the interior clean by reducing the amount of cooking grease adhering to it.</p>
 <p>Fan with upper and lower elements: The elements combined with the fan aim to provide more uniform heat, a similar method to conventional cooking, so pre-heat is required. Most suitable for items requiring slow cooking methods.</p>	 <p>Upper and lower element only: a traditional cooking method best suited for single items located in the centre of the oven. the top pf the oven will always be hottest. Ideal for roast, fruit cakes, bread etc.</p>
 <p>Lower heating element only: This function is ideal for foods that require extra base temperature without browning, e.g. pastry dishes, pizza. Also suitable for slow cooking of stews and casseroles.</p>	 <p>Circulaire: The combination of the fan and circular element around it gives a hot air cooking method. This provides many benefits including no preheat if cook time is more than 20 minutes, no flavour transfer when cooking different foods at the same time, less energy, and shorter cook times. Good for all types of food.</p>
 <p>ECO: The combination of the grill, fan and lower element is particularly suitable for cooking small quantities of food.</p>	 <p>Grill element: Using of grill gives excellent results when cooking meat of medium and small portions, especially when combined with a rotisserie (where possible). Also ideal for cooking sausages and bacon.</p>
 <p>Fan with grill element: The fan reduces the fierce heat from the grill, providing an excellent method of grilling various foods, chops, steaks, sausages etc. giving even browning and heat distribution, without drying out the food. The top two levels recommended for use, and the lower part of the oven can be used to keep items warm at the same time, an excellent facility when cooking a grilled breakfast. Half grill (centre portion only) is ideal for small quantities of food.</p>	 <p>Circulaire with upper and lower elements: The use of the fan with both elements allows food to be cooked quickly and effectively, ideal for large joints that require thorough cooking. It offers a similar result to rotisserie, moving the heat around the food, instead of moving the food itself, enabling any size or shape to be cooked.</p>
 <p>The inner door glass: can be removed with a few quick movements for cleaning.</p>	 <p>Side lights: Two opposing side lights increase visibility inside the oven.</p>
 <p>Rapid preheat: The rapid preheat function can be used to reach the selected temperature in just a few minutes.</p>	 <p>The oven cavity has 5 different cooking levels.</p>
 <p>Vapor Clean: a simple cleaning function using steam to loosen deposits in the oven cavity.</p>	 <p>The capacity indicates the amount of usable space in the oven cavity in litres.</p>