

ASSEMBLY INSTRUCTIONS

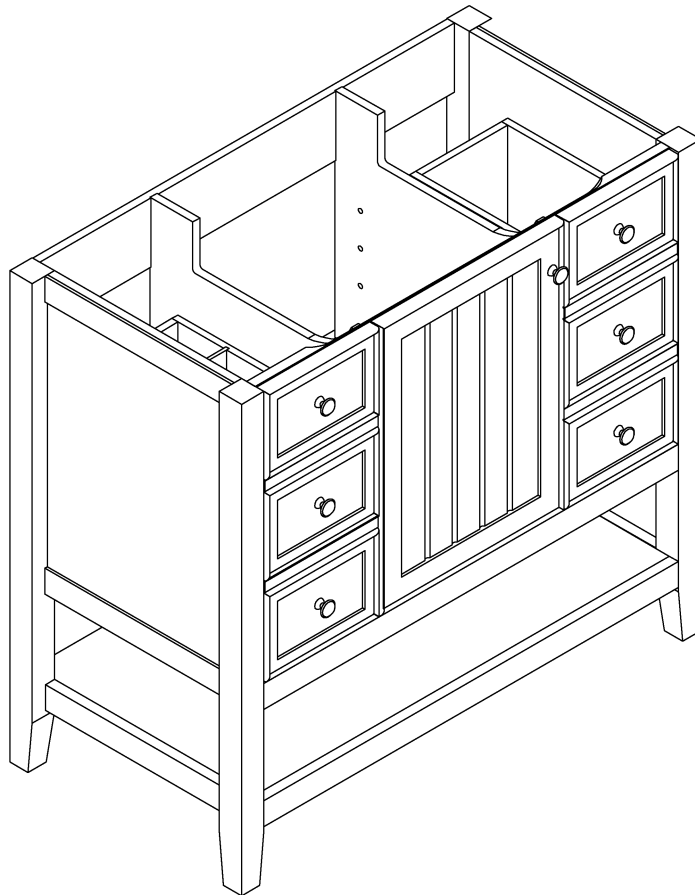

Thank you for purchasing this quality product. Be sure to check all packing material carefully for small parts which may have come loose inside the carton during shipment. Separate, identify and count all parts and hardware. Compare with the parts list to be sure all parts are present.
"DO NOT TIGHTEN SCREWS UNTIL COMPLETELY ASSEMBLED"

*** Use of power tool to assemble this product will invalidate any claim and damage this product making unsafe !!!**
*** Please assemble on a clean soft surface to avoid damage.**

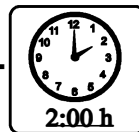
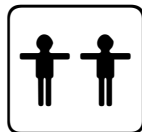
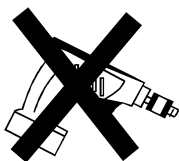

Tools Required

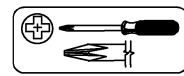

(Not included)

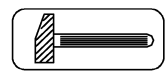

(Not included)

IMPORTANT:

PLEASE READ INSTRUCTION BEFORE STARTING THE ASSEMBLY

Thank you for buying our products.

Please read the installation manual carefully before installation,

we need you to follow the instructions on the accessories and hardware

step by step assembly complete, our instructions are very detailed.

Products are environmentally friendly products,

Please rest assured that you do not soak in water, do not place very heavy items,

do not malicious push and pull,

if you have any problems in the process of assembly and use, please contact us.

Thank you again for your purchase of our products,

I wish you a happy life.

**Slides Must Be Separated Before Assembly.
After Separated, Set Aside Until Needed for Assembly.**

Las diapositivas deben separarse antes del montaje.
Después de la separación, déjelo a un lado hasta que sea necesario.

Les glissières doivent être séparées avant l'assemblage.
Après la séparation, mettez de côté jusqu'au moment de l'assemblage.

**Pay attention when connecting !
The sliding module must be at the front end.**

**STEP 1 : Extend Slide
Extender la diapositiva**

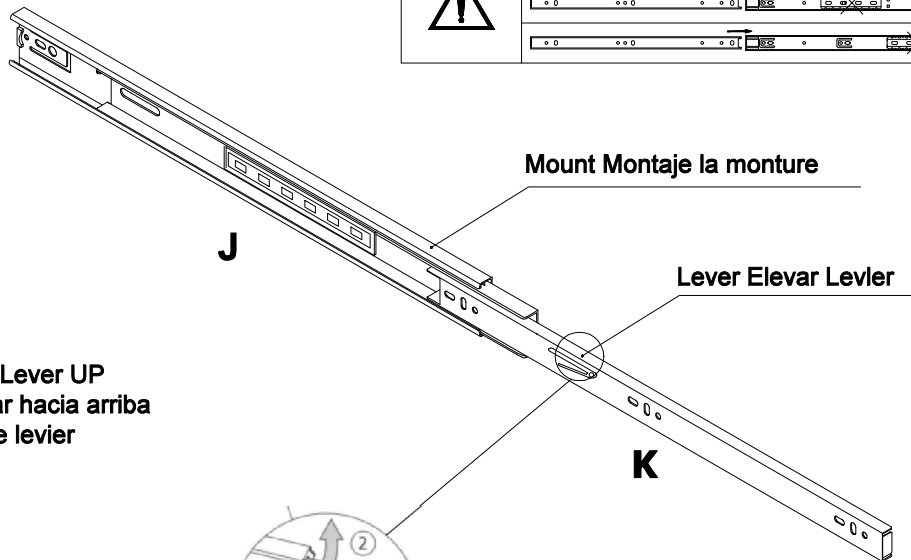
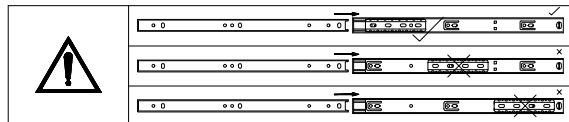

**STEP 2: Push Lever UP
Empujar hacia arriba
Lever le levier**

**Push lever for the left of drawer ,
press the lever for the right of drawer.**

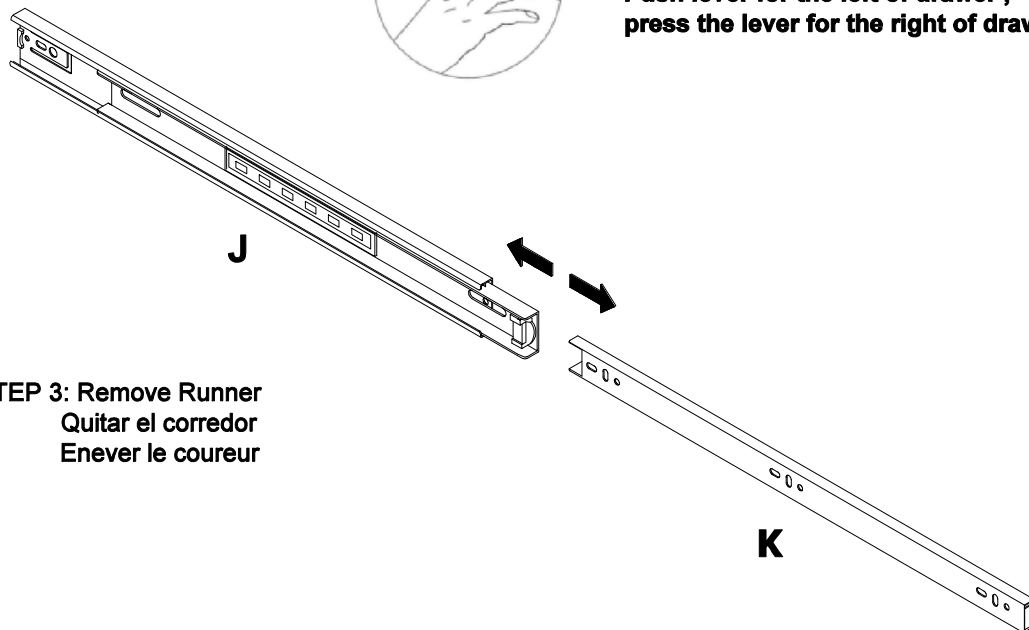





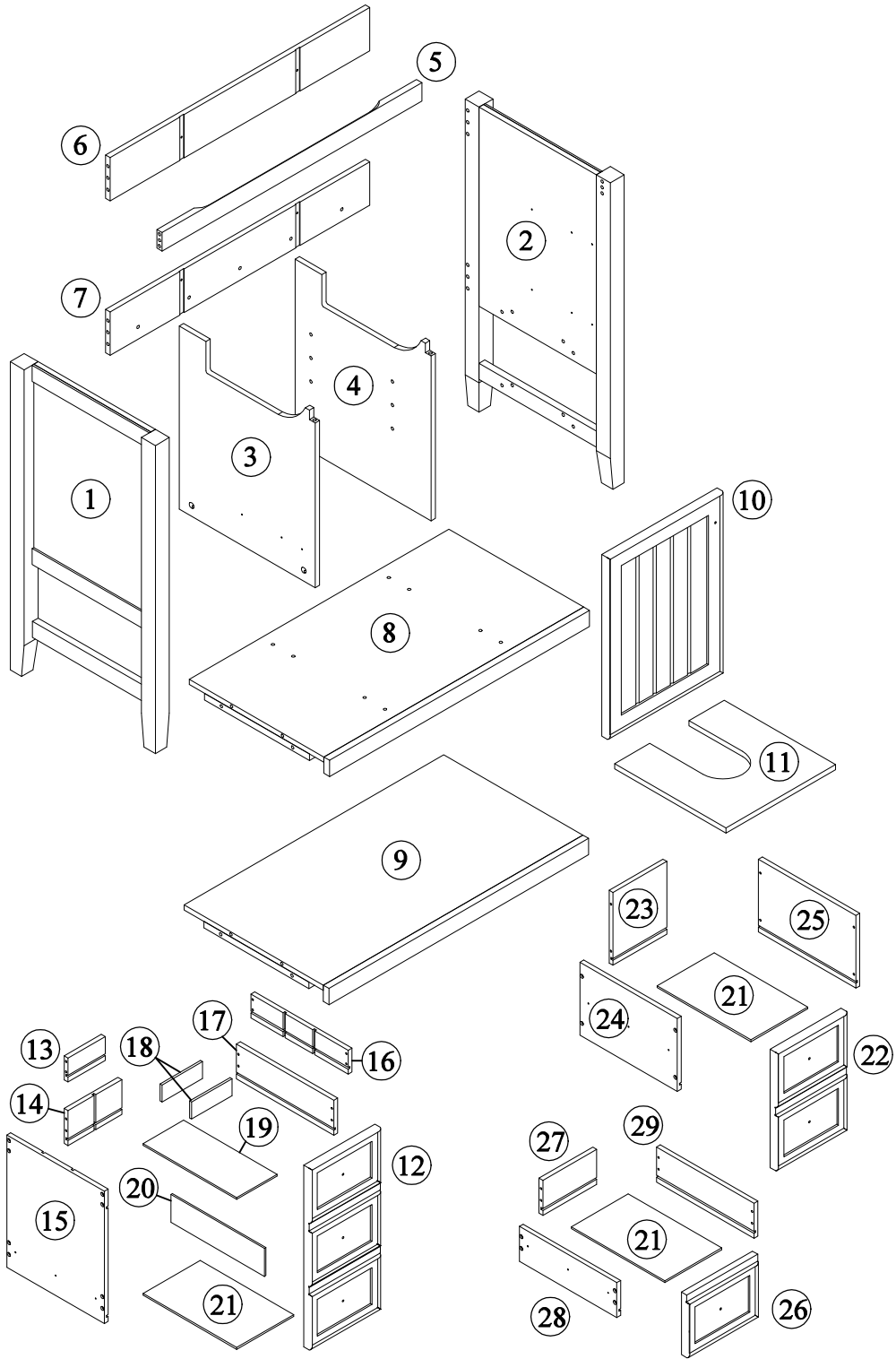



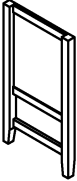
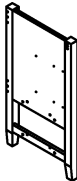



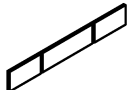
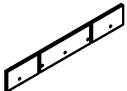
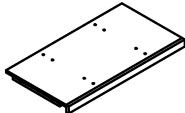
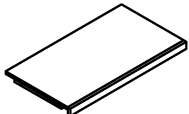
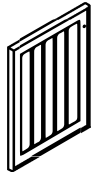
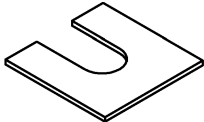

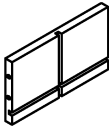
**STEP 3: Remove Runner
Quitar el corredor
Enlever le coureur**

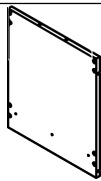
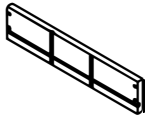
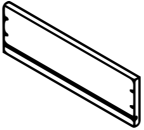

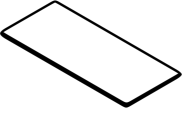
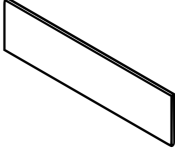
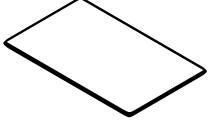

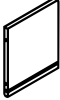
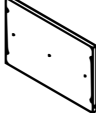
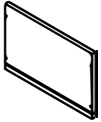
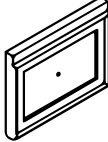

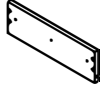





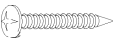

Detail View - CABINET

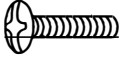
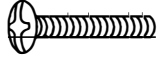
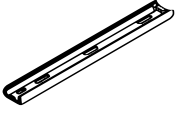
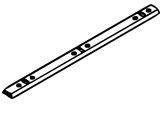

Identifying the Hardware-Identify the hardware using the illustrations below.

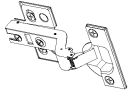
<p>1</p>  <p>Side Panel (L) - 1pc</p>	<p>2</p>  <p>Side Panel (R) - 1pc</p>
<p>3</p>  <p>Panel Mid (L) - 1pc</p>	<p>4</p>  <p>Panel Mid (R) - 1pc</p>
<p>5</p>  <p>Crossbar Top - 1pc</p>	<p>6</p>  <p>Rear Panel Top - 1pc</p>
<p>7</p>  <p>Rear Panel Bottom - 1pc</p>	<p>8</p>  <p>Frame Mid - 1pc</p>
<p>9</p>  <p>Frame Bottom - 1pc</p>	<p>10</p>  <p>Door - 1pc</p>
<p>11</p>  <p>Adjustable Shelf - 1pc</p>	<p>12</p>  <p>Left Drawer Face - 1pc</p>
<p>13</p>  <p>Left Drawer Rear panel(A) - 1pc</p>	<p>14</p>  <p>Left Drawer Rear panel(B) - 1pc</p>

<p>15</p>  <p>Left Drawer Side panel (L) - 1pc</p>	<p>16</p>  <p>Left Drawer Side panel (R-T) - 1pc</p>
<p>17</p>  <p>Left Drawer Side panel (R-B) - 1pc</p>	<p>18</p>  <p>Drawer divide (A) - 2pcs</p>
<p>19</p>  <p>Left Drawer Bottom - 1pc</p>	<p>20</p>  <p>Drawer divide (B) - 1pc</p>
<p>21</p>  <p>Drawer Bottom - 3pcs</p>	<p>22</p>  <p>Right Drawer Face (T) - 1pc</p>
<p>23</p>  <p>Right Drawer Rear panel (T) - 1pc</p>	<p>24</p>  <p>Right Drawer Side panel (L-T) - 1pc</p>
<p>25</p>  <p>Right Drawer Side panel (R-T) - 1pc</p>	<p>26</p>  <p>Right Drawer Face (B) - 1pc</p>
<p>27</p>  <p>Right Drawer Rear panel (B) - 1pc</p>	<p>28</p>  <p>Right Drawer Side panel (L-B) - 1pc</p>
<p>29</p>  <p>Right Drawer Side panel (R-B) - 1pc</p>	

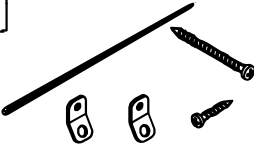
<p>A</p>  <p>ø13x1/4"x28mm</p>	<p>B</p>  <p>ø1/4"x16x1mm</p>	<p>C</p>  <p>ø6x35mm</p>
<p>Hex-Head bolts (8pcs) Washer (8pcs) Three in one bolts (17pcs)</p>		
<p>D</p>  <p>ø14.5x12mm</p>	<p>E</p>  <p>ø8xø4x25mm</p>	<p>F</p>  <p>ø8xø4x32mm</p>
<p>Three in one lock (17pcs) Round head screw (4pcs) Round head screw (32pcs)</p>		
<p>G</p>  <p>Handle (7pcs)</p>	<p>H</p>  <p>ø5/32"x15mm</p>	<p>I</p>  <p>ø5/32"x20mm</p>
<p>Handle (7pcs) Handle screw (3pcs) Handle screw (4pcs)</p>		
<p>J</p>  <p>ø300x35mm</p>	<p>K</p>  <p>ø298x18mm</p>	<p>L</p>  <p>ø6xø3x12mm</p>
<p>Slide rails (6pcs) Slide rails (6pcs) Flat head screw (36pcs)</p>		
<p>M</p>  <p>L-Bracket (2pcs)</p>	<p>N</p>  <p>ø7xø3.5x12mm</p>	<p>O</p>  <p>Laminate pad(4pcs)</p>
<p>L-Bracket (2pcs) Round head screw (4pcs) Laminate pad(4pcs)</p>		
<p>P</p>  <p>Damping hinge (2pcs)</p>	<p>Q</p>  <p>ø7xø3.5x15mm</p>	<p>R</p>  <p>ø8x30mm</p>
<p>Damping hinge (2pcs) Flat head screw (12pcs) Wood dowel (24pcs)</p>		
<p>S</p>  <p>4mm</p>	<p>T</p>  <p>Anti fall hardware (1set)</p>	
<p>Allen key (1pc) Anti fall hardware (1set)</p>		

STEP: 1

C

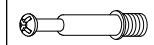

17PCS

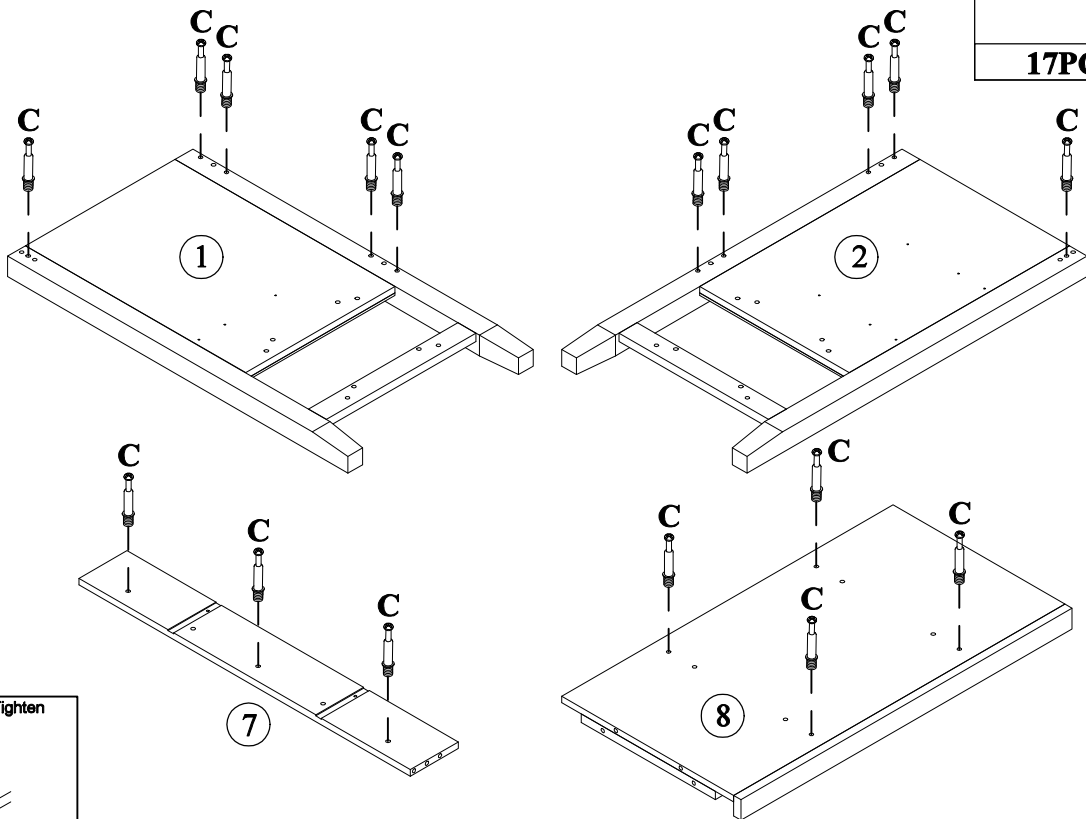

Do Not Over Tighten

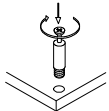

STEP: 2

J



6PCS

L



18PCS

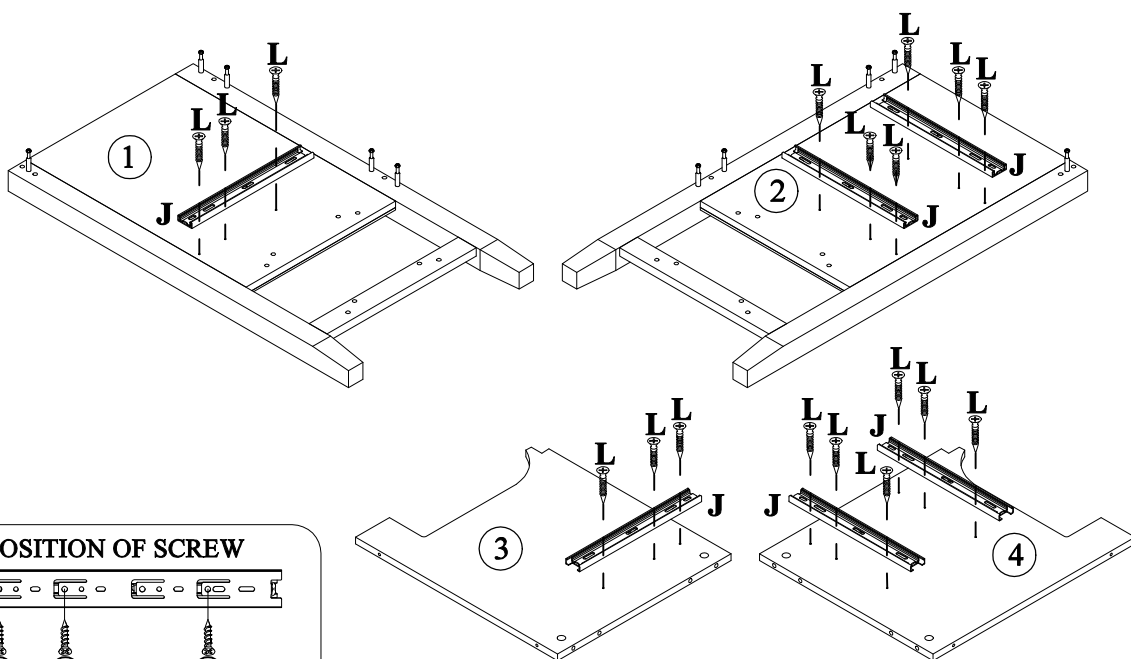

POSITION OF SCREW



1

2

1

STEP: 3

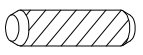
D		R	
	4PCS		4PCS

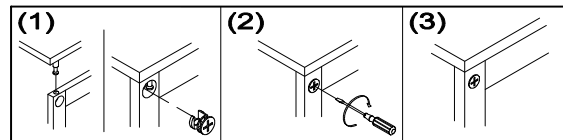
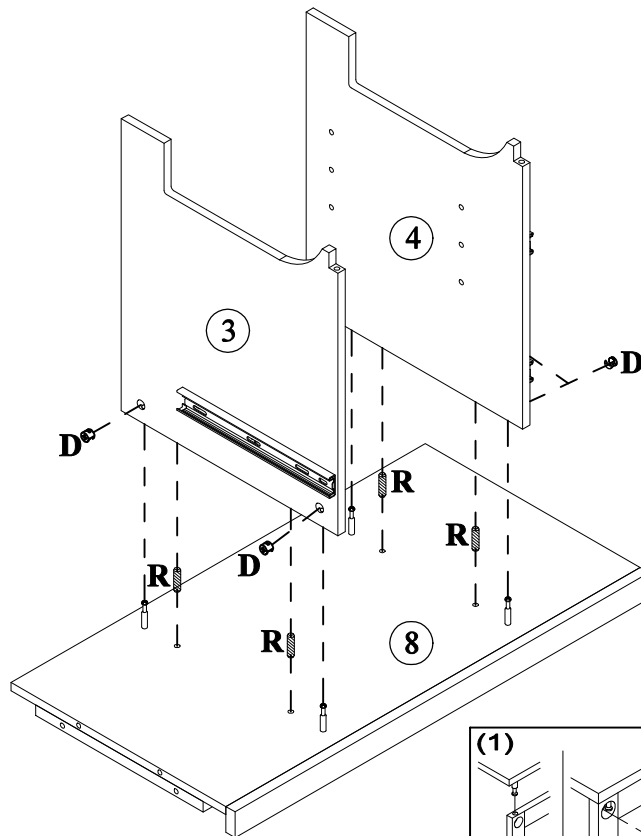

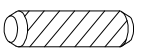
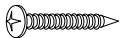

STEP: 4

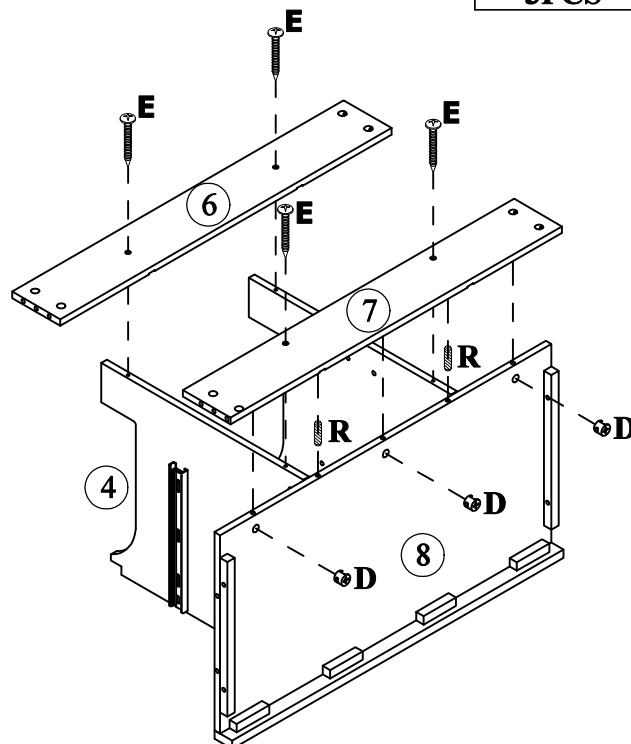
D		R		E	
	3PCS		2PCS		4PCS



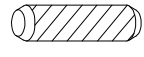

STEP: 5

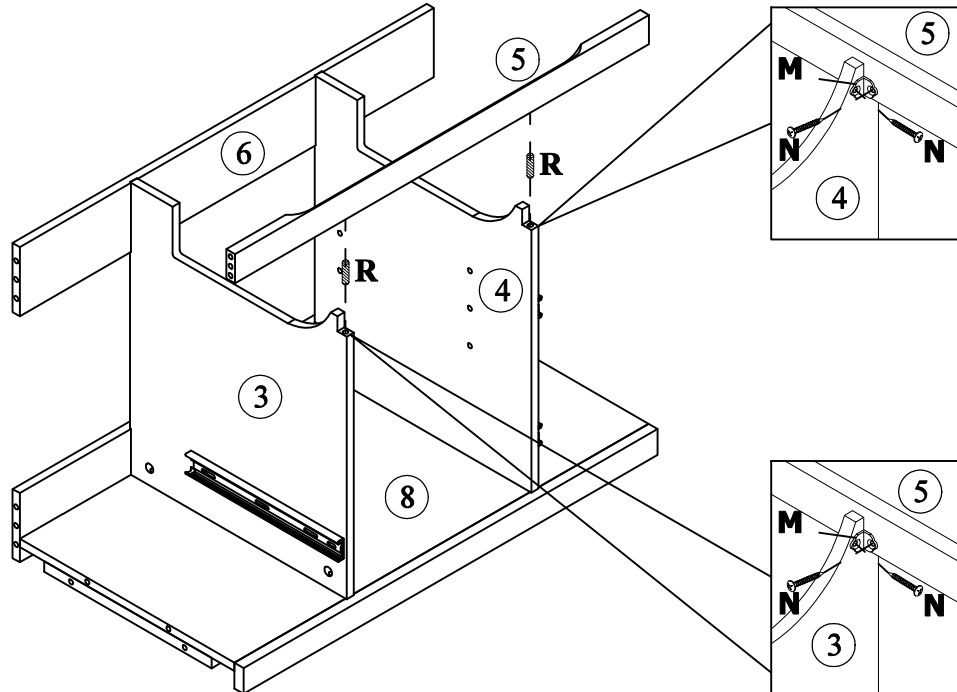
M 	N 	R 
2PCS	4PCS	2PCS



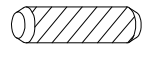

STEP: 6

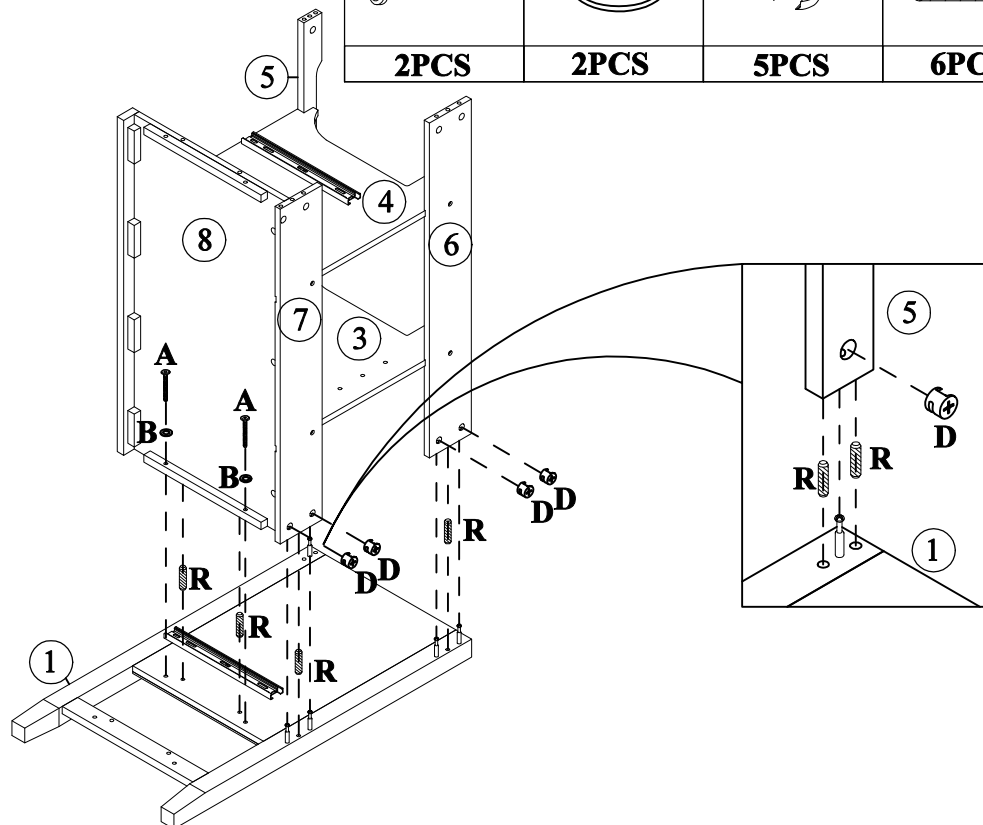
A 	B 	D 	R 
2PCS	2PCS	5PCS	6PCS

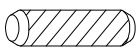

STEP: 7

A	B	R
		
2PCS	2PCS	2PCS

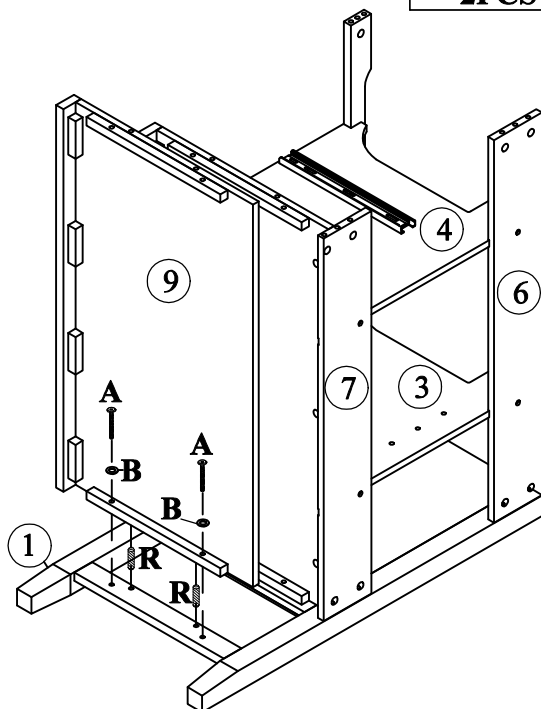

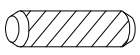

STEP: 8

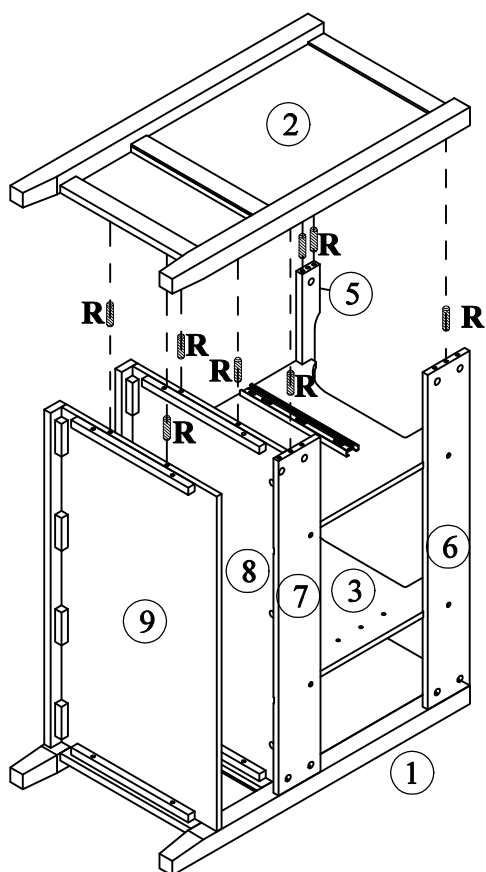
R

8PCS



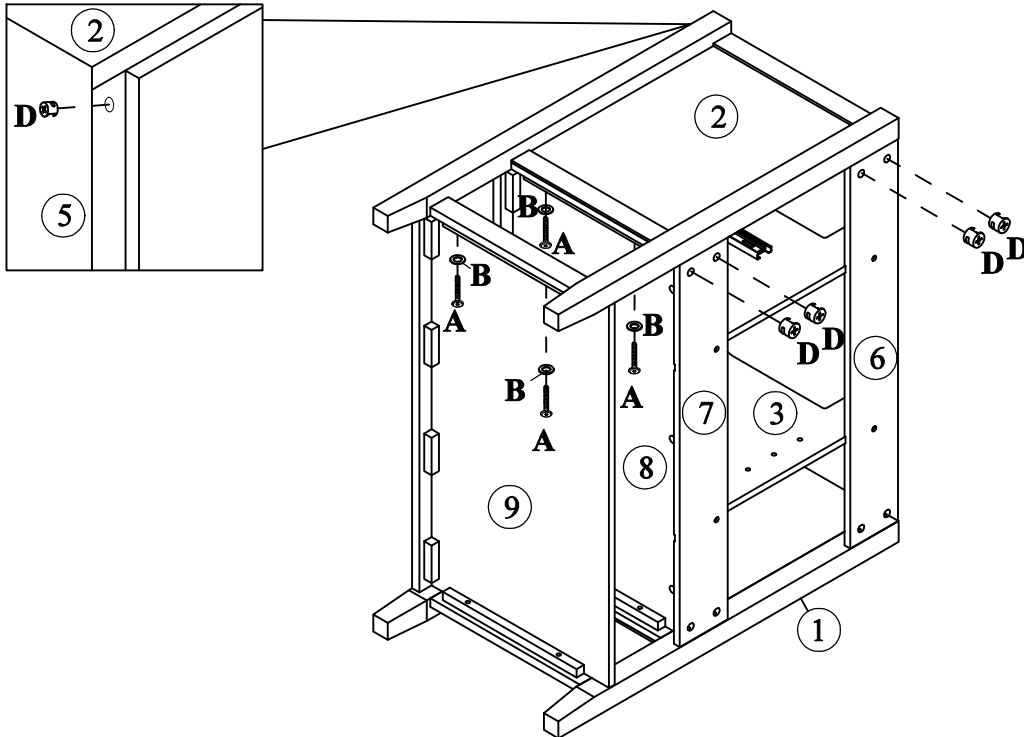

STEP: 9

A	B	D
		
4PCS	4PCS	5PCS



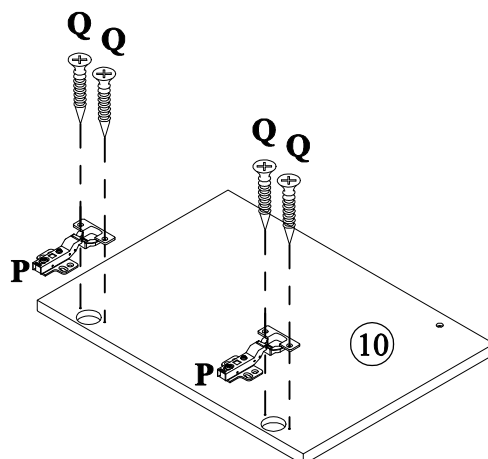

STEP: 10

P	Q
	
2PCS	4PCS

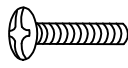

STEP: 11

G	I	Q
		
1PC	1PC	8PCS

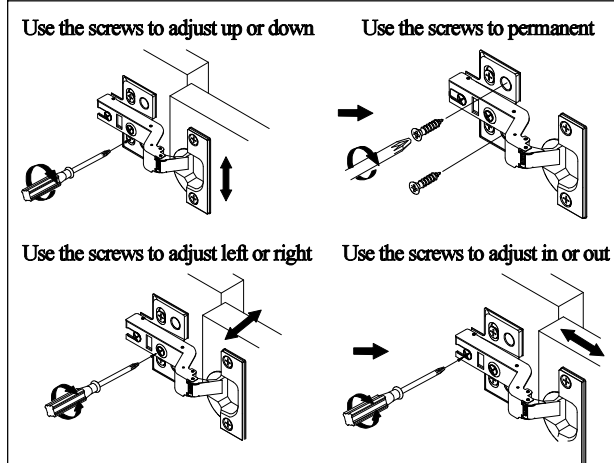
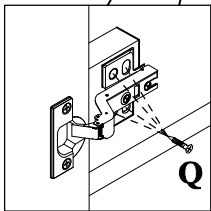
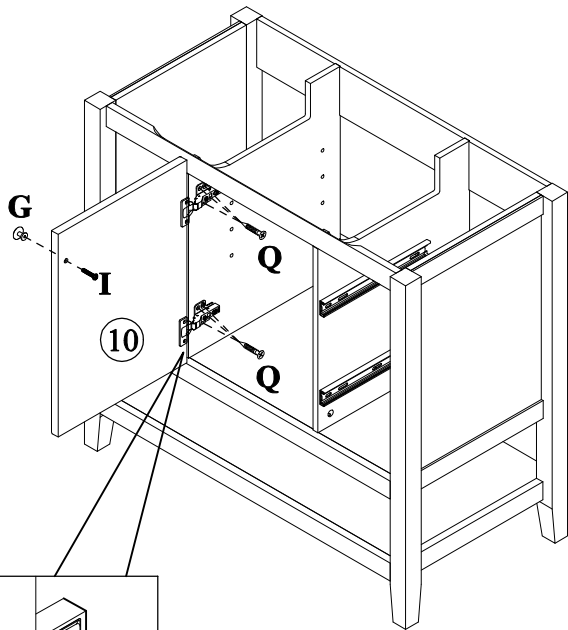

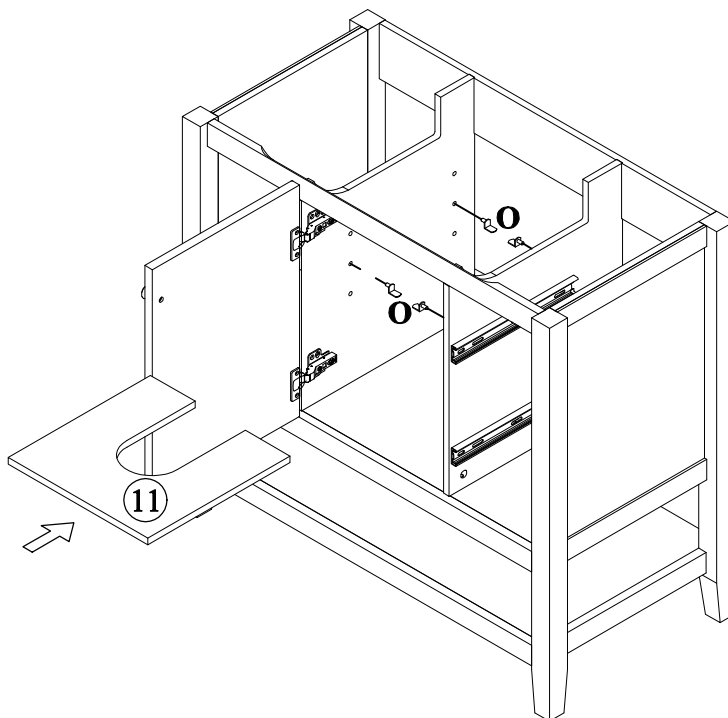

STEP: 12

O

4PCS

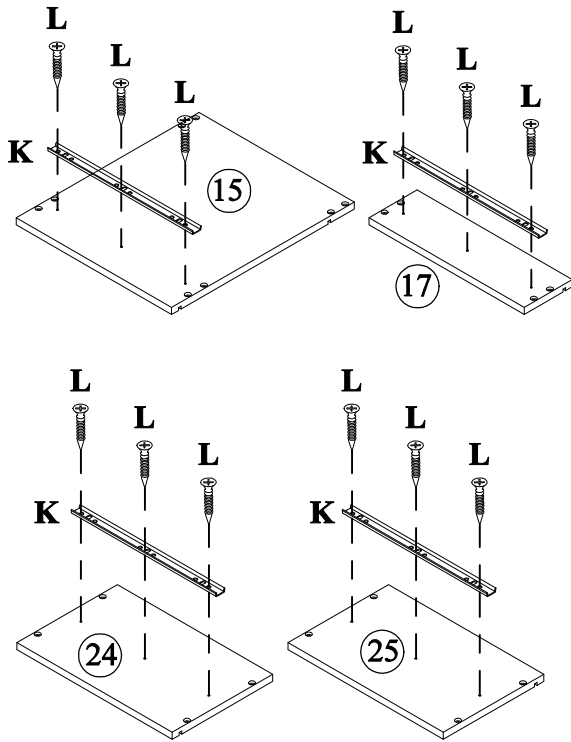

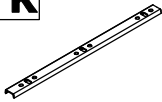
STEP: 13



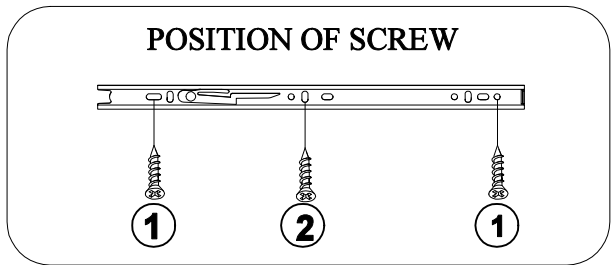
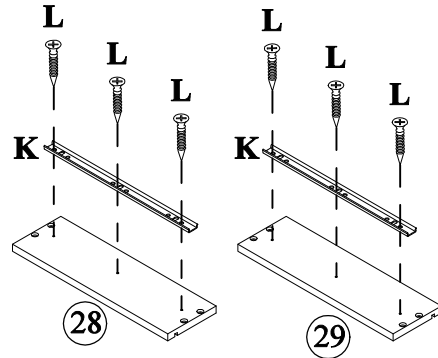

K		L	
	6PCS		18PCS

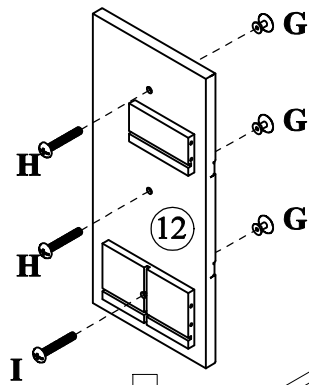

STEP: 14

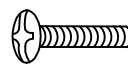

G		H		I		F	
	3PCS		2PCS		1PC		10PCS

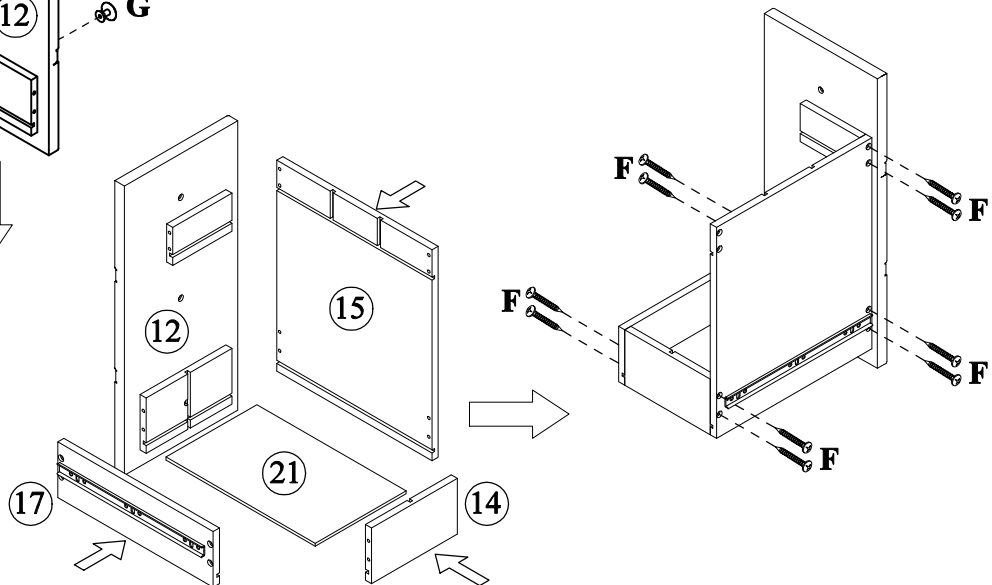



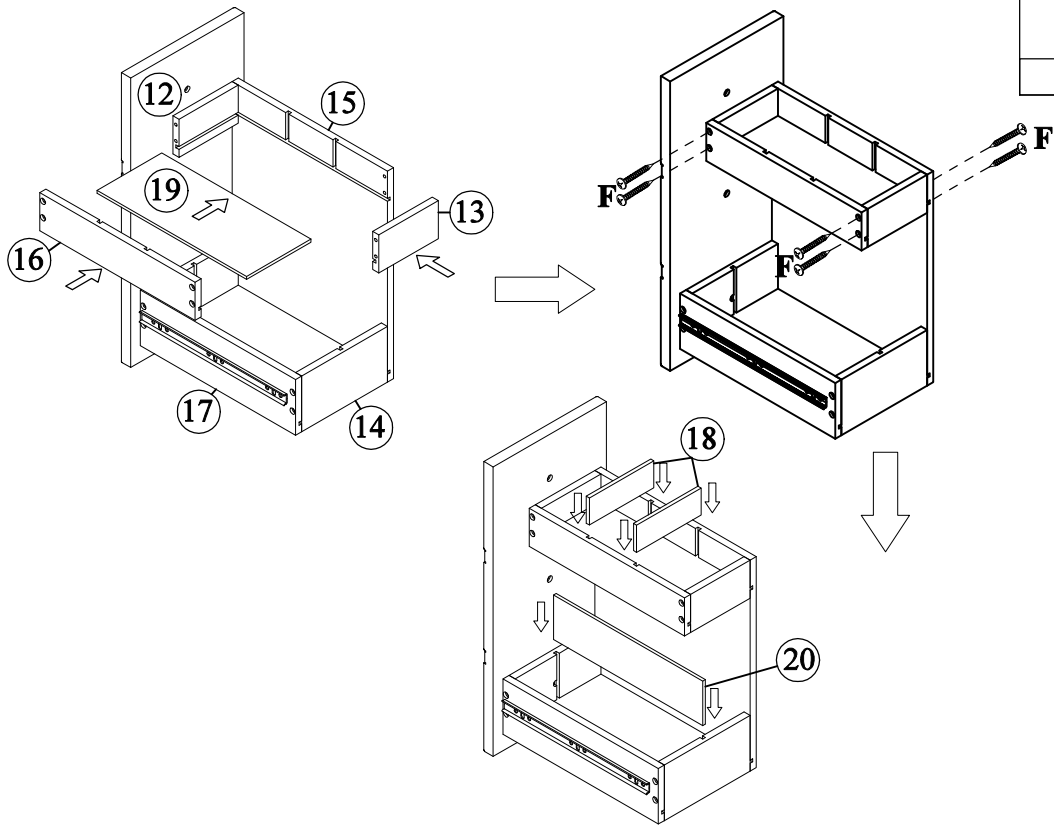

STEP: 15

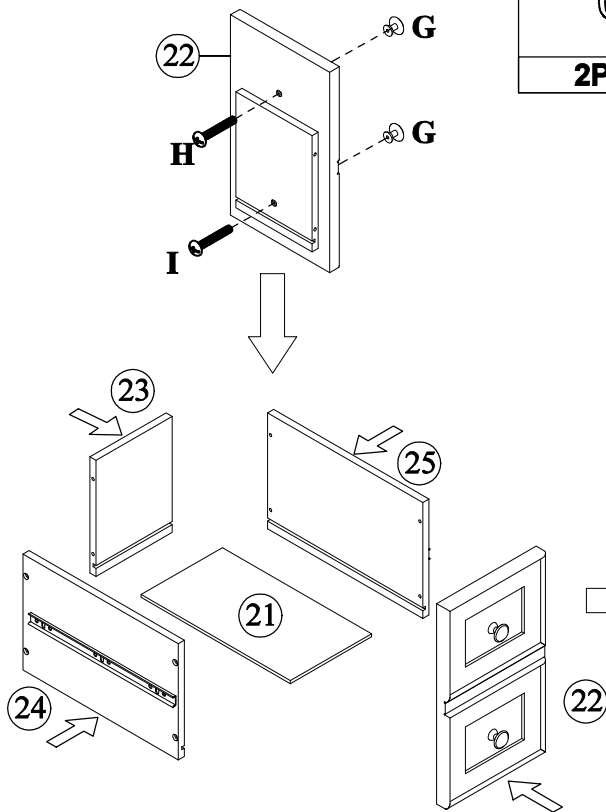

F

6PCS

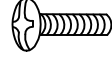
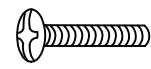

STEP: 16

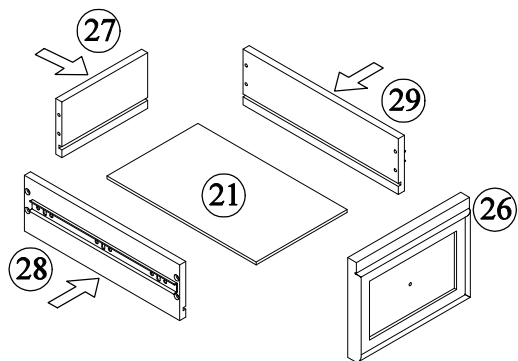

G	H	I	F
			
2PCS	1PC	1PC	8PCS

STEP: 17

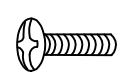

G 	I 	F 
1PC	1PC	8PCS

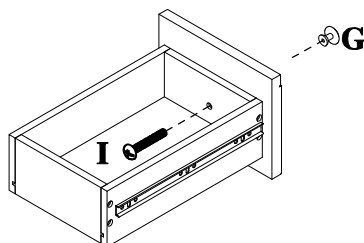
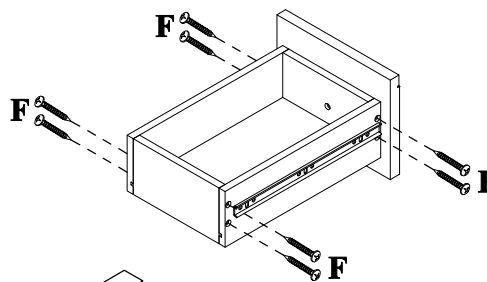

STEP: 18

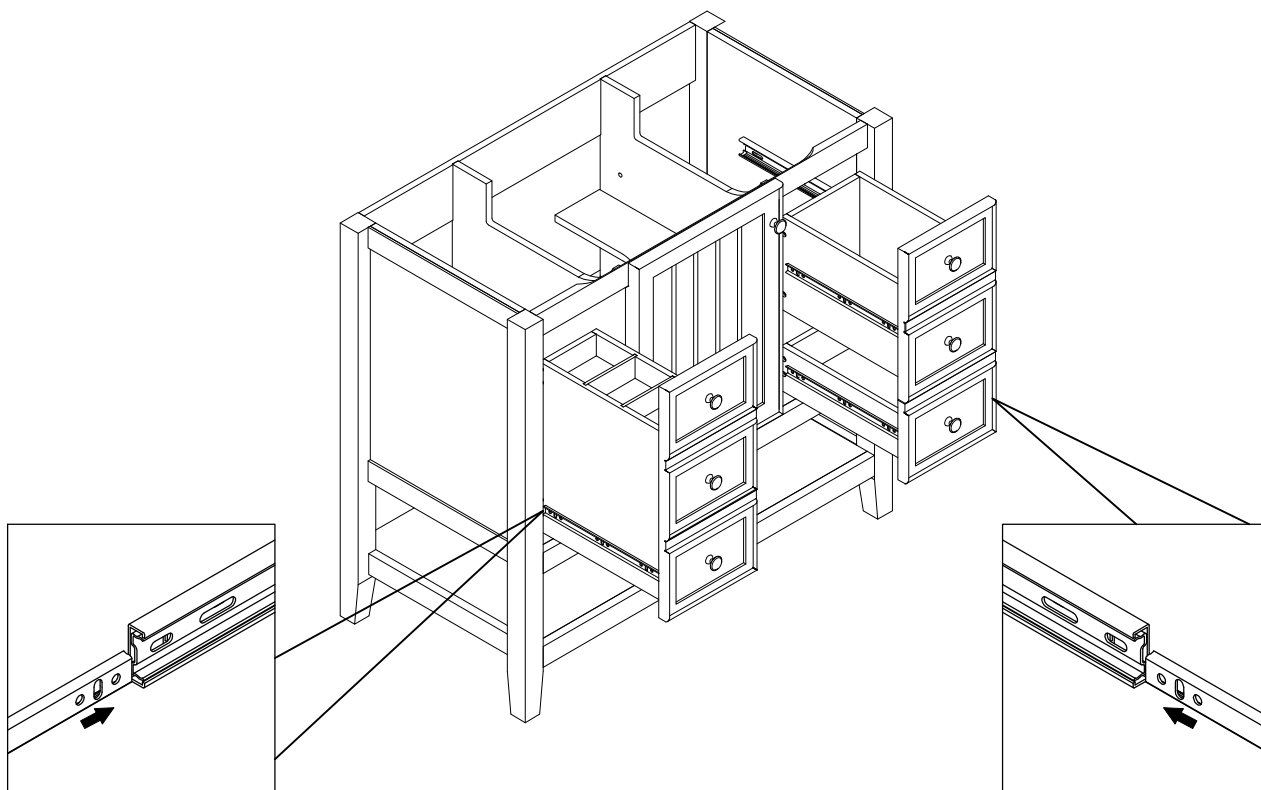

STEP: 19

T

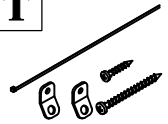

1SET

Wall

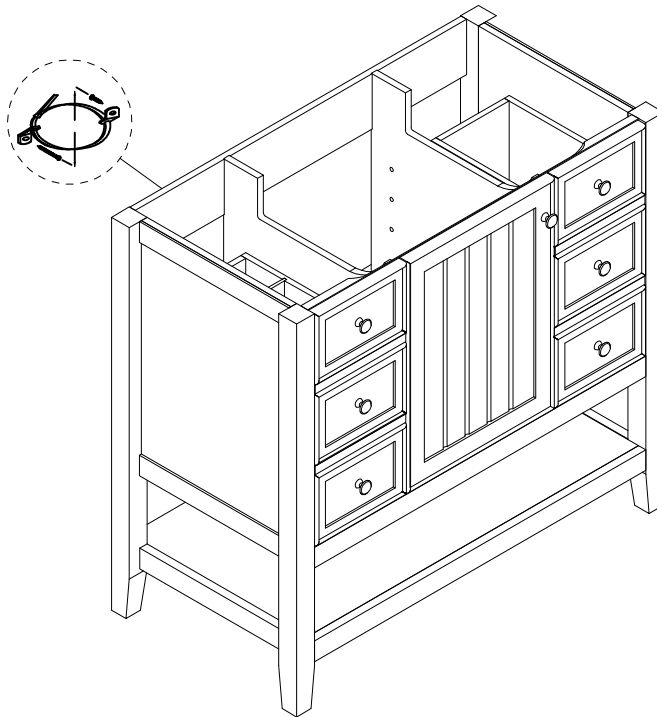

STEP: 20

Install the sink on the cabinet with glue.
Let stand for 24 hours

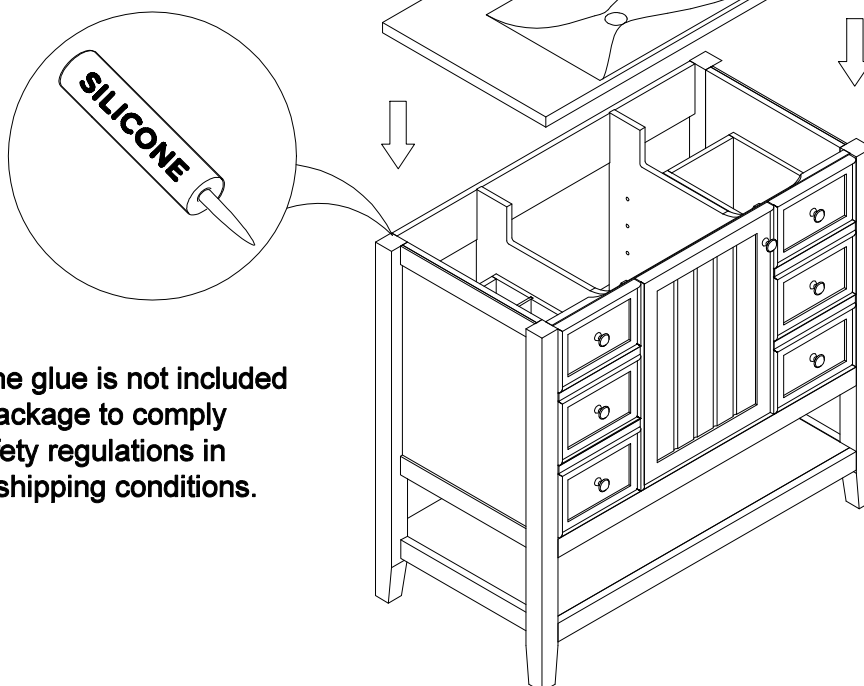

*Silicone glue is not included in the package to comply with safety regulations in certain shipping conditions.

STEP: 21

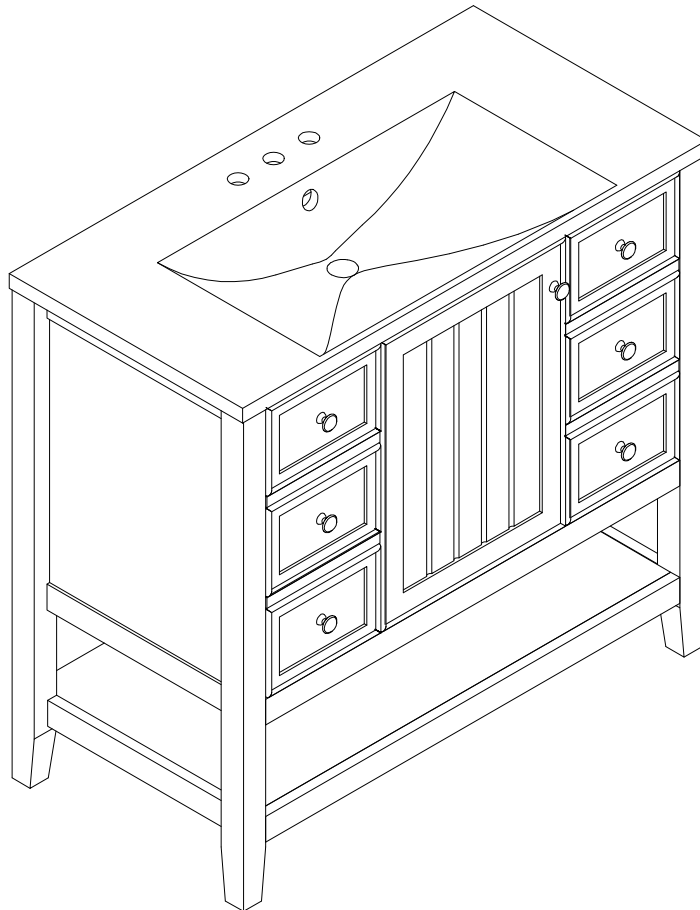

HINGE ADJUSTMENTS



1 Sideways / Tilt adjustment

Turn the screw
clockwise to move the door further away from
the side of the cabinet
anticlockwise to move the door closer to the
side of the cabinet

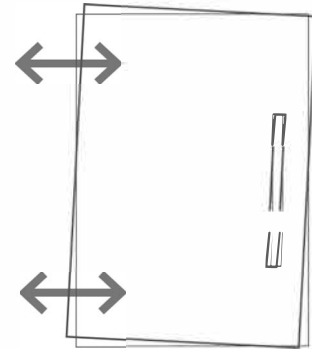

2 4 Height adjustment

While supporting the weight of the door, turn the
screws
clockwise to move the door up
anticlockwise to move the door down

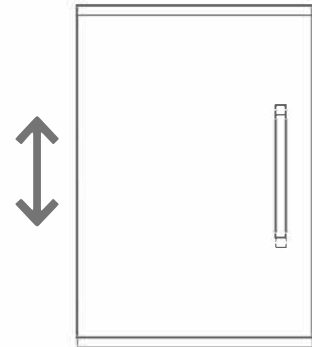

3 Forward and back adjustment

If the gap between the back of the door and the
cabinet is too small, and the door may not close
fully. Turn the screw
clockwise to decrease the gap between the
door and the cabinet
anticlockwise to increase the gap between the
door and the cabinet

