

ASSEMBLY INSTRUCTION

TABLE

A Table Top



1pc

B Legs



3pcs

C Connecting
Plate



3pcs

D Screw

M5X14MM



9pcs

E Screw

M5X14MM



6pcs

F Wrench

M5



1pc



This page lists all the contents included in the box. Please take the time to identify the hardware as well as the individual components to this product. As you unpack and prepare for assembly, place the contents on a carpeted or padded area to protect product from damage.

- 1** Install connecting plate (C) to leg (B) with wrench (F) turn the screw (E) in it. Make sure screw (E) is tight.

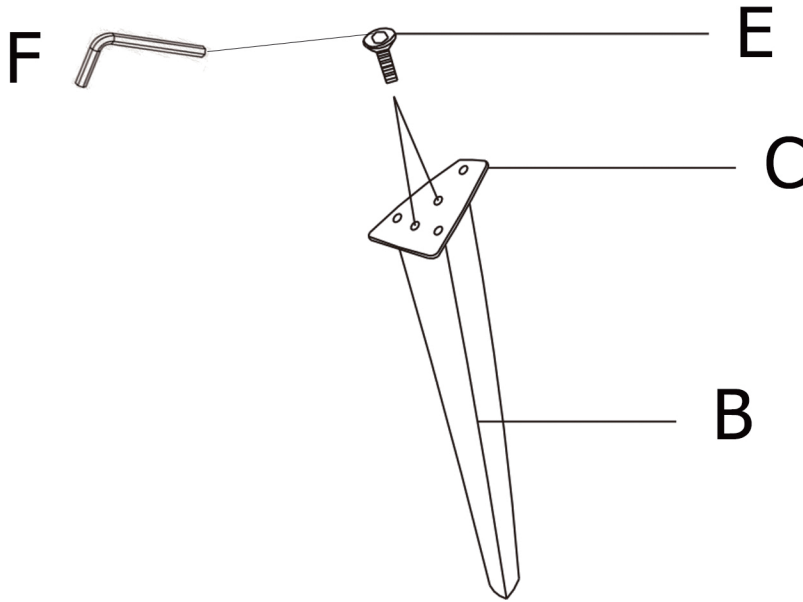

- 2** Install legs (B) to table top (A) with wrench (F) turn the screw (D) in it. Make sure all screw (D) is tight.

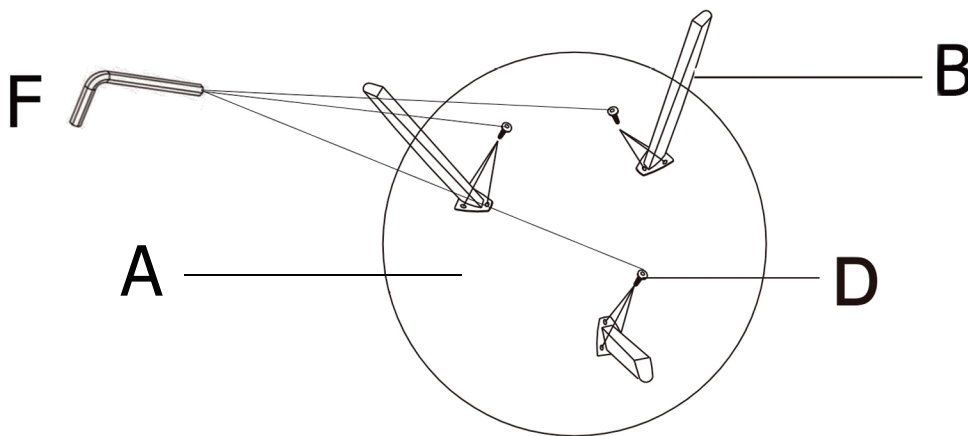

Cleaning & Care

Treat surface with care. Surface is resistant to scratches but is not scratch resistant. Clean surfaces with a dry or damp soft cloth. Do not use abrasive cleaners. Hardware may loosen over time. Periodically check that all connections are tight.