











Installation

Hardware List		Hardware List	
 Table top	1	 Table leg	1
 Support frame	1	 Table base	1
 8x16mm screws and washers	4	 8x25mm screws and washers	9
 8x35mm screw washers*8 and nuts	4	 Spare 4x15mm Self-tapping screws	8
 Hexagonal screw tap	1	 Wrench	1

1



8x25mm screw

2

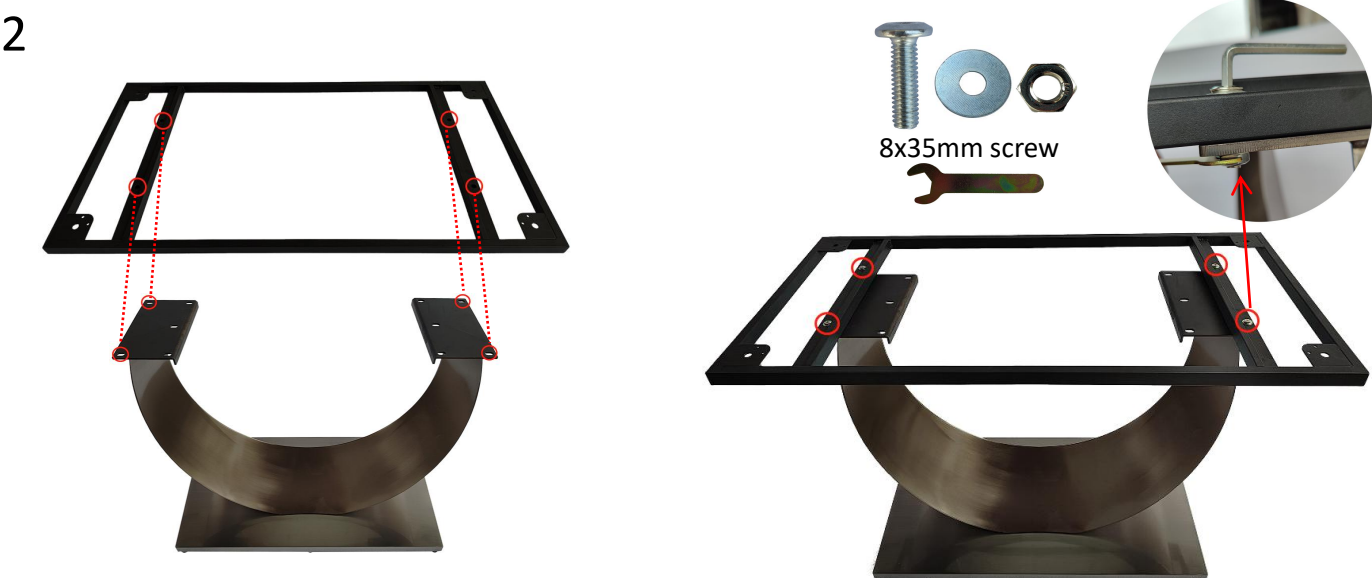

8x35mm screw

3



8x16mm screw

Adjustable foot pads at the bottom of the support legs (when the ground is uneven, the foot pads can be used to adjust the balance).





This is a spare screw hole. When the 8x16mm screw fails to be screwed in, the hole can be fixed with a 4x15mm self-tapping screw. Either way will do.

Put the table top on the table leg, make sure the reserved screw holes of the table top and the frame are corresponding, tighten 8x16mm screws from the bottom to finish the installation.



Installation MH-DC1

To avoid scratches and swallowing parts, please do not install by children!

Hardware List		Hardware List	
	1 Seat		1 Backrest
	2 Frame		2 M5x15mm screws
	4 M8x60mm screws		

1 The frame is affixed with the letters A and B respectively, and is placed and installed according to the diagram. Be careful not to install the opposite direction.

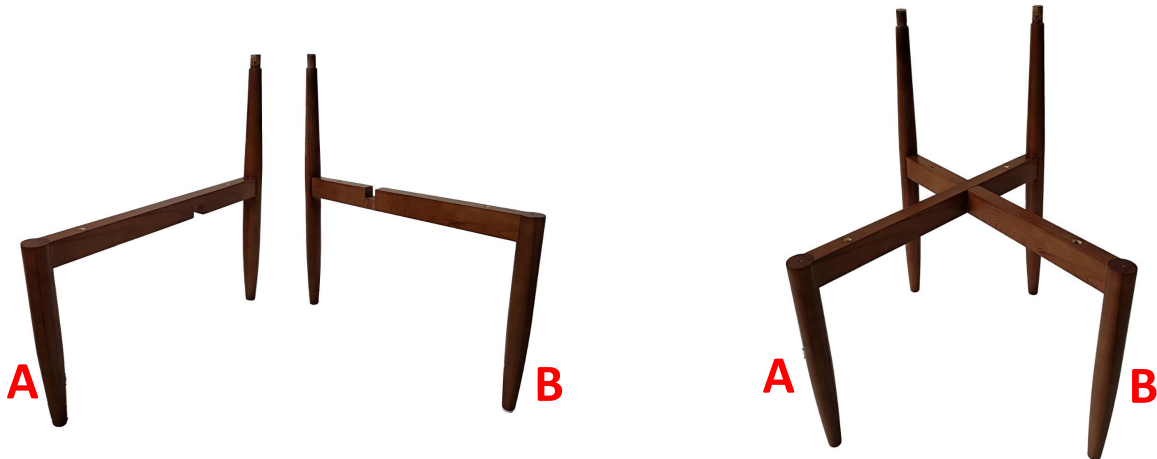

2



3

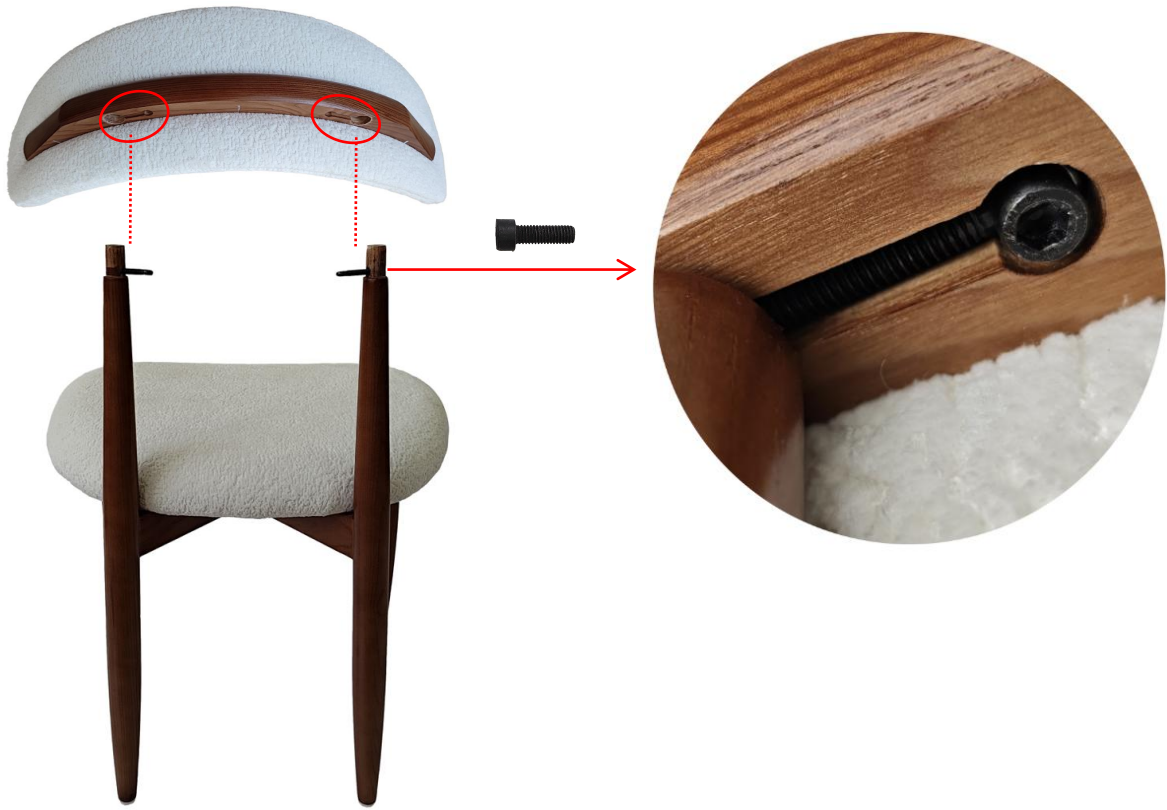

4

