

BAR STOOL

ASSEMBLY INSTRUCTION



Assembly Instruction

ASSEMBLY TIPS:







1. Remove hardware from box and sort by size.
2. Please check to see that all hardware and parts are present prior to start of assembly.
3. Please follow attached instructions in the same sequence as numbered to assure fast & easy assembly.

Warning!



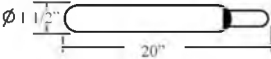

1. Don't attempt to repair or modify parts that are broken or defective. Please contact the store immediately.
2. This product is for home use only and not intended for commercial establishment.

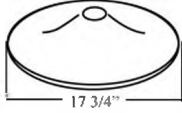
PARTS IDENTIFICATION



<p>A: CHAIR BACK</p>  <p>1PCS</p>	<p>B: CHAIR SEAT</p>  <p>1PCS</p>
<p>C: BACK SUPPORT</p>  <p>1PCS</p>	<p>D: FOOTREST</p>  <p>1PCS</p>
<p>E: GAS CYLINDER</p>  <p>1PCS</p>	<p>F: DECORATIVE RING</p>  <p>1PCS</p>
<p>G: CHAIR BASE</p>  <p>1PCS</p>	

Z HARDWARE PACKAGE

NO	DESCRIPTION	FIGURE	Q'TY
1	LARGE BOLTS 1/4" x 3/4"		4PCS +1EXT
2	SMALL BOLTS 1/4" x 1/2"		4PCS +1EXT
3	LARGE BOLTS 1/4" x 3/4"		3PCS +1EXT
4	ALLEN WRENCH M6		1PCS
5	ALLEN WRENCH M4		1PCS

ASSEMBLY INSTRUCTION

STEP 1

It needs two person and takes about ten minutes to assemble this item.

Remove sheath (black cover) of the gas cylinder (E) before attaching it to the decorative ring (F) and the chair base (G).

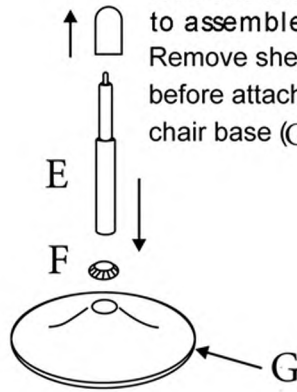

STEP 2

Place the chair seat (B) and chair back (A) upside down on a soft surface. Next, attachment the back support (C) to the chair seat (B) and chair back (A) using bolt (1) and bolt (3) and tighten with the allen wrench (4) and (5).

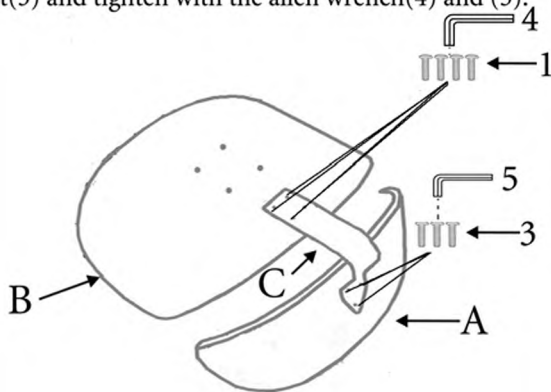

STEP 3

Next attachment the footrest (D) to the chair seat (B) using the bolt (2) and tighten with the allen wrench (4).

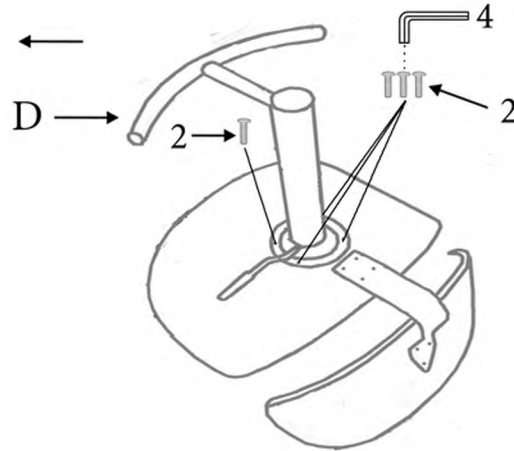

STEP 4

Connect the footrest to the gas cylinder (E) and the chair base (G) press firmly to the top of the gas spring AS SHOWN IN THE DRAWING.

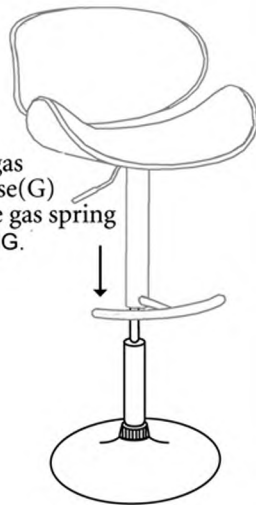

STEP 5

