

ASSEMBLY INSTRUCTION

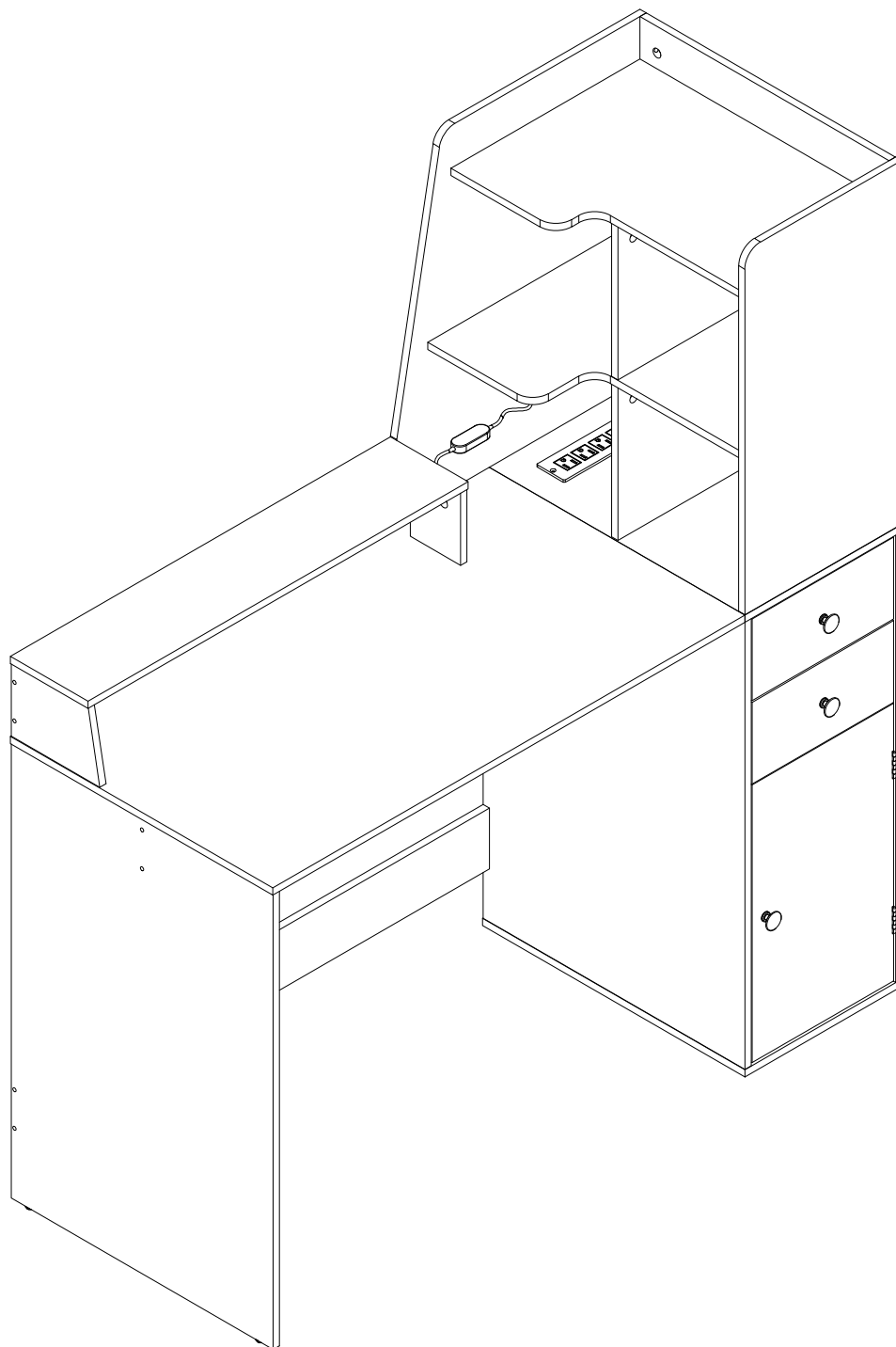

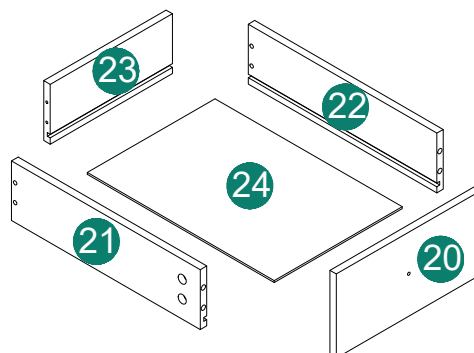
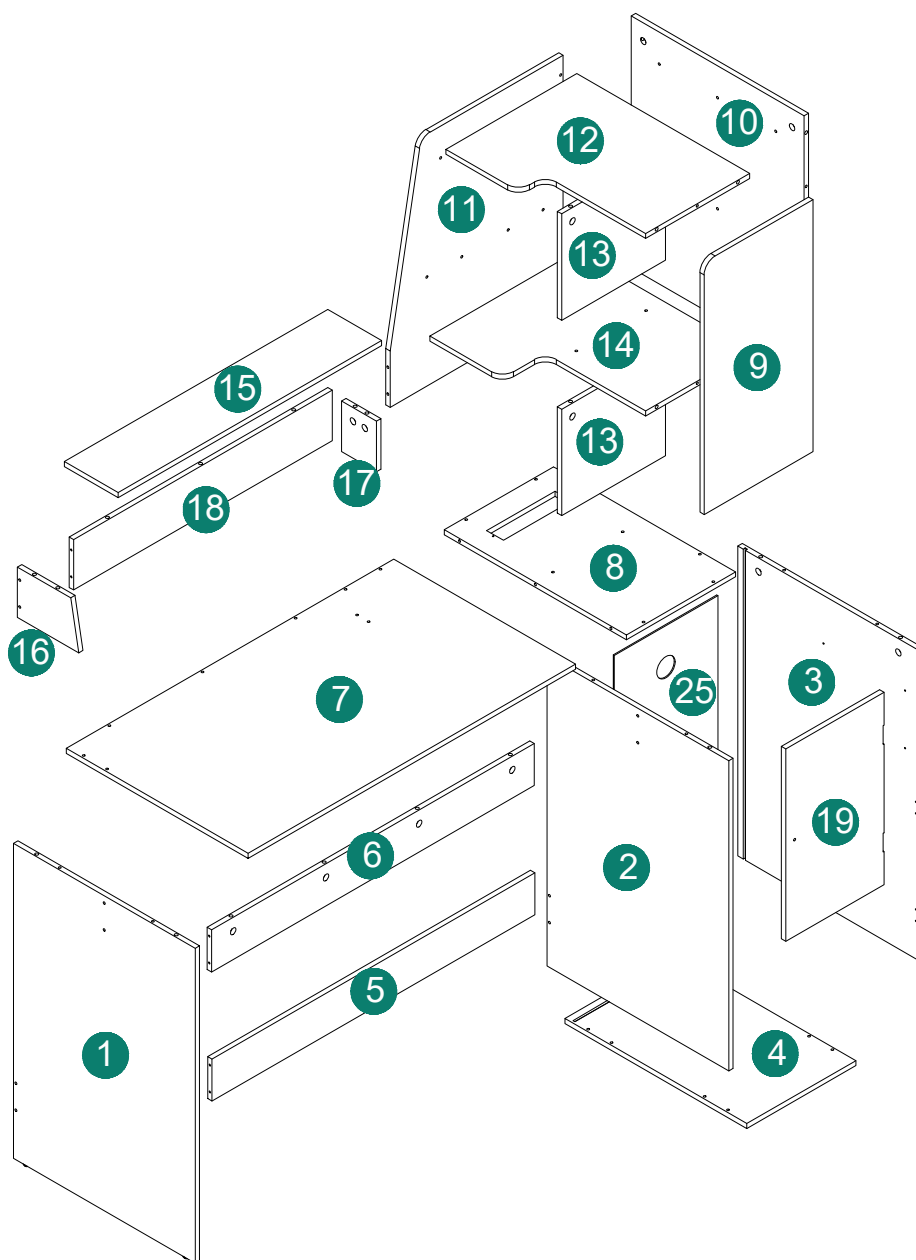

x2

1

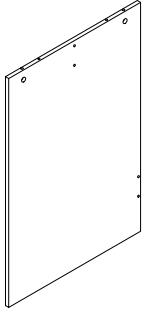

1PC

2

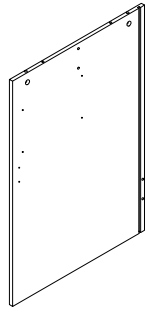

1PC

3

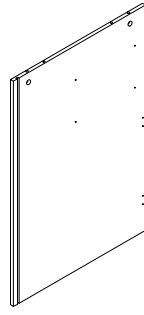

1PC

4

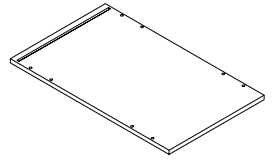

1PC

5

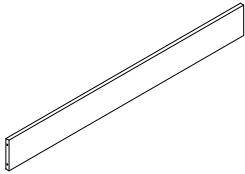

1PC

6

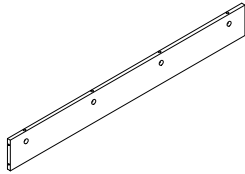

1PC

7

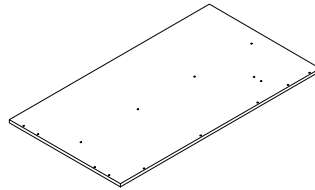

1PC

8

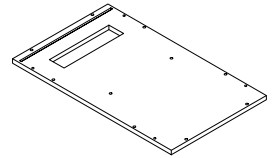

1PC

9

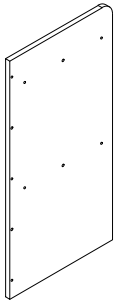

1PC

10

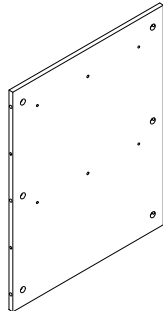

1PC

11

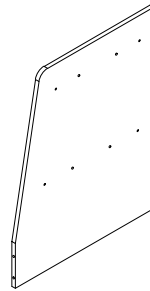

1PC

12

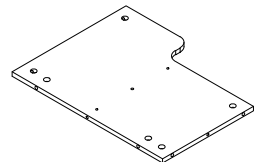

1PC

13

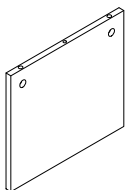

2PCS

14

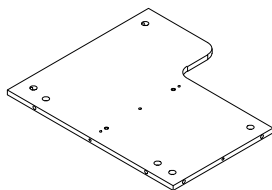

1PC

15

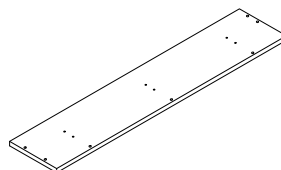

1PC

16

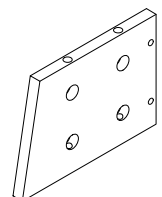

1PC

17

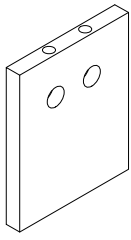

1PC

18

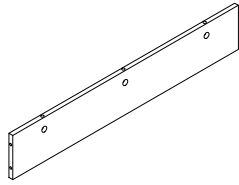

1PC

19

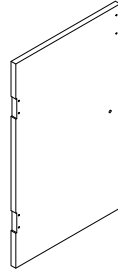

1PC

20

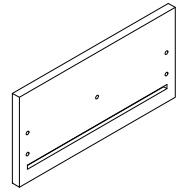

2PC

21

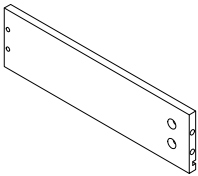

2PCS

22

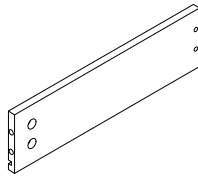

2PCS

23

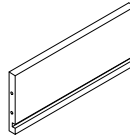

2PCS

24

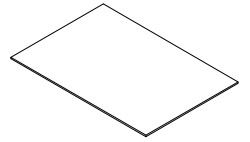

2PCS

25



1PC

A

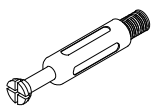

M6*40

49PCS

B

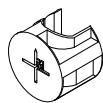

φ15*9.3mm

49PCS

C

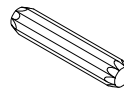

φ6*30mm

28PCS



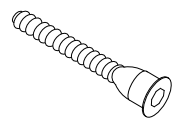





D

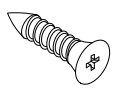
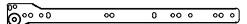
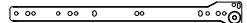
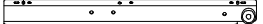

M5*38

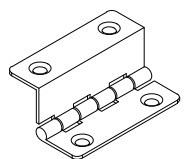
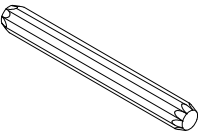
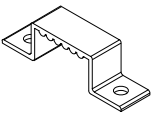
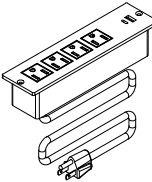
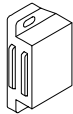
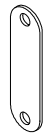
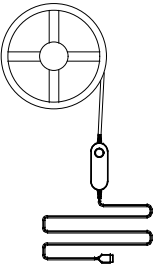
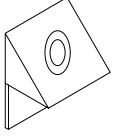
37PCS

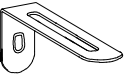
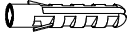
			P

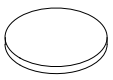
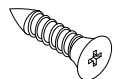
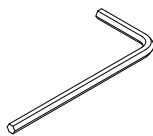
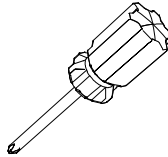
<p>E</p>  <p>M3*12</p> <p>34PCS</p>	<p>F</p> <p>CL </p> <p>CR </p> <p>DL </p> <p>DR </p> <p>350mm</p> <p>2PCS</p>	<p>G</p> <p>G1 </p> <p>G2 </p> <p>M4*15</p> <p>3PCS</p>	<p>H</p>  <p>2PCS</p>
<p>I</p>  <p>∅6*50mm</p> <p>3PCS</p>	<p>J</p>  <p>3PCS</p>	<p>K</p>  <p>2m</p> <p>1PC</p>	<p>L</p> <p>L1 </p> <p>L2 </p> <p>1PC</p>
<p>M</p>  <p>1PC</p>	<p>N</p>  <p>6PCS</p>	<p>O</p> <p>M4*12</p>     <p>1PC</p>	<p>P</p>  <p>33PCS</p>
<p>Q</p>  <p>M3*14</p> <p>8PCS</p>	 <p>3MM</p> <p>1PC</p>	 <p>1PC</p>	

3

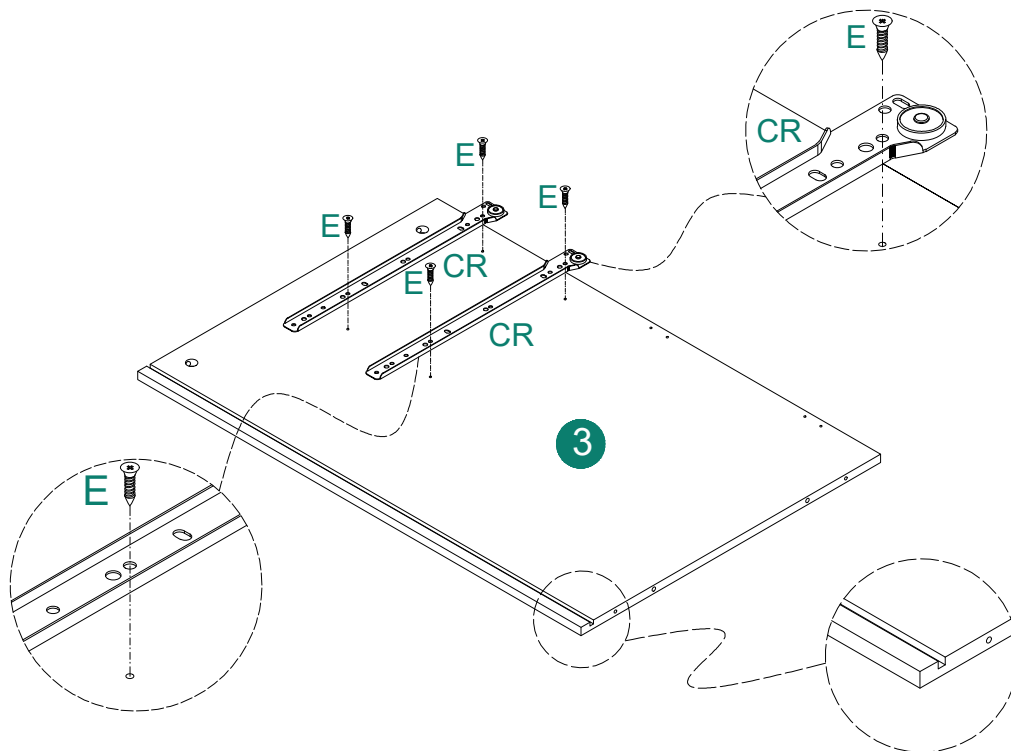
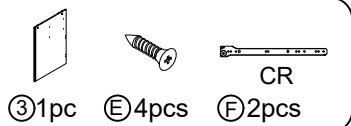

4

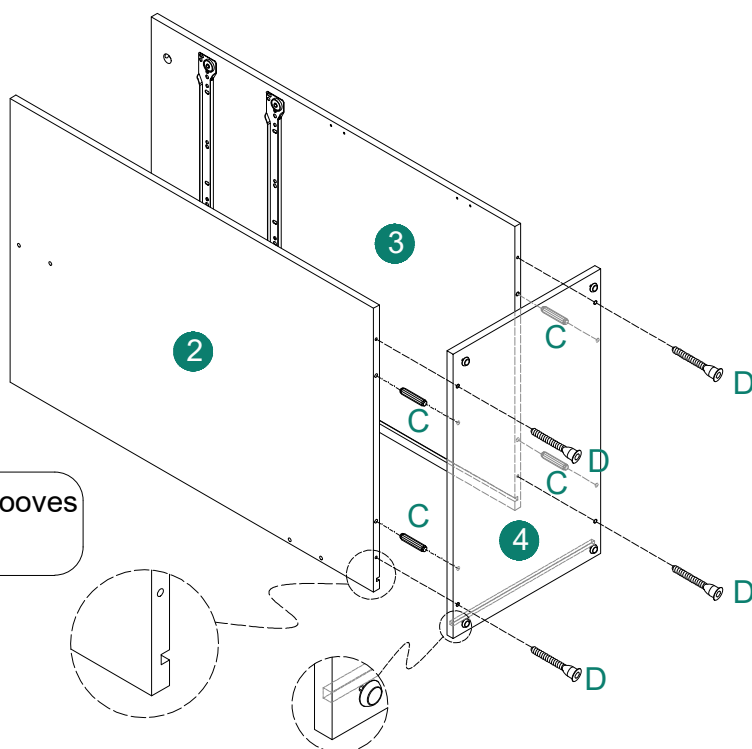
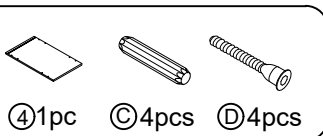

Please note that the grooves are on the same side

5

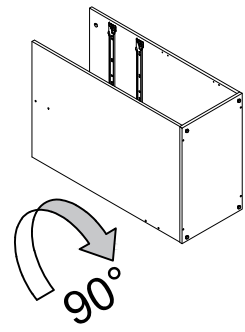
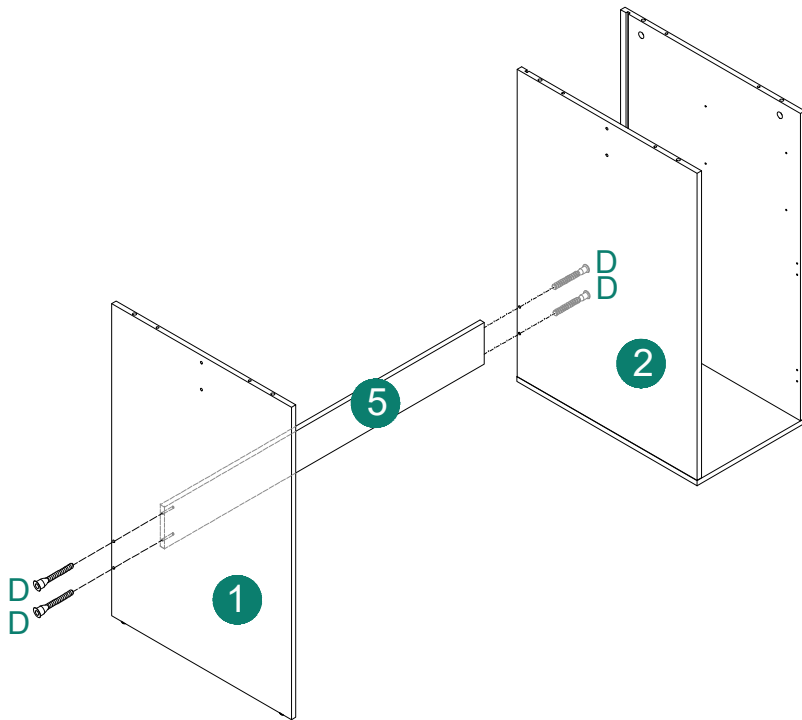
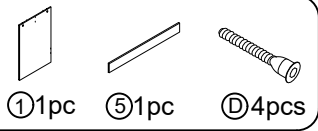

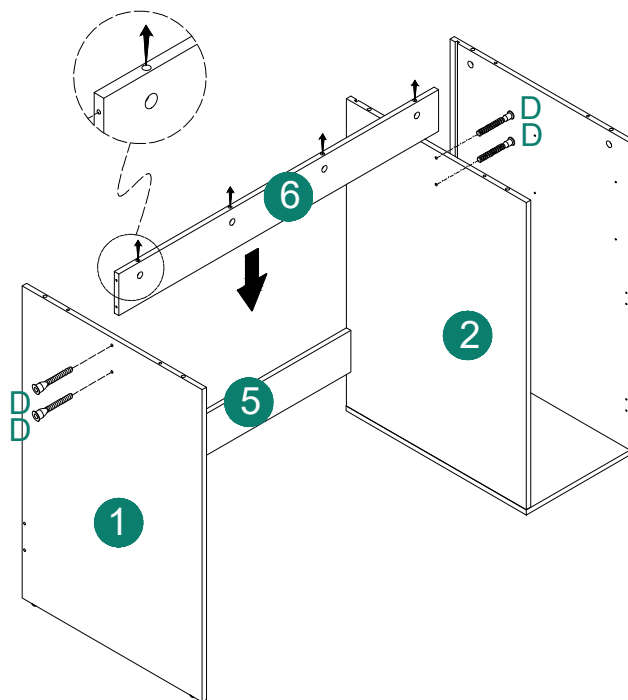
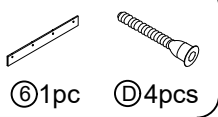

6

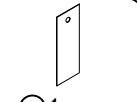

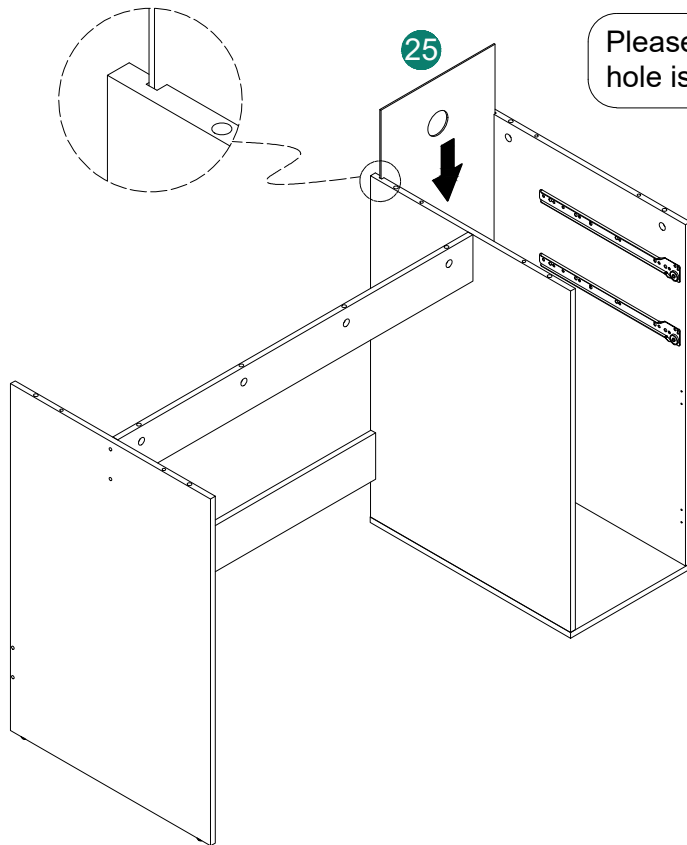
7 
②5 1pc



Please note that the round hole is on the upper side

8   
⑦ 1pc ⑧ 1pc ① 3pcs

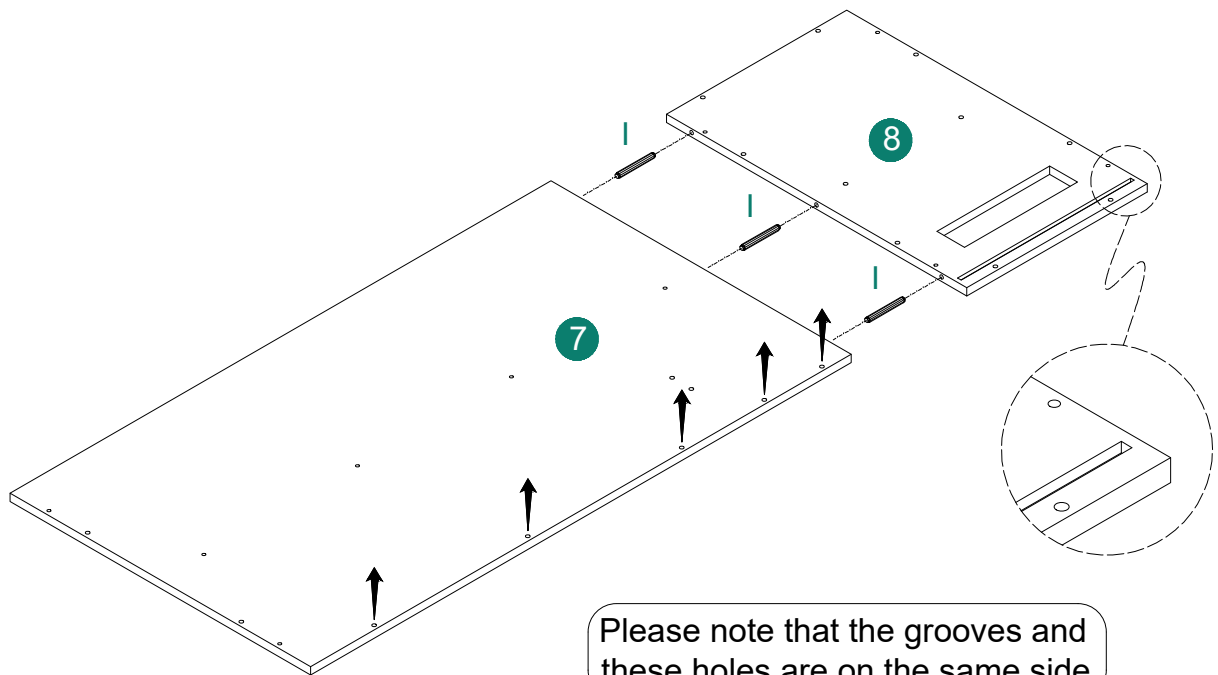

Please note that the grooves and these holes are on the same side



9

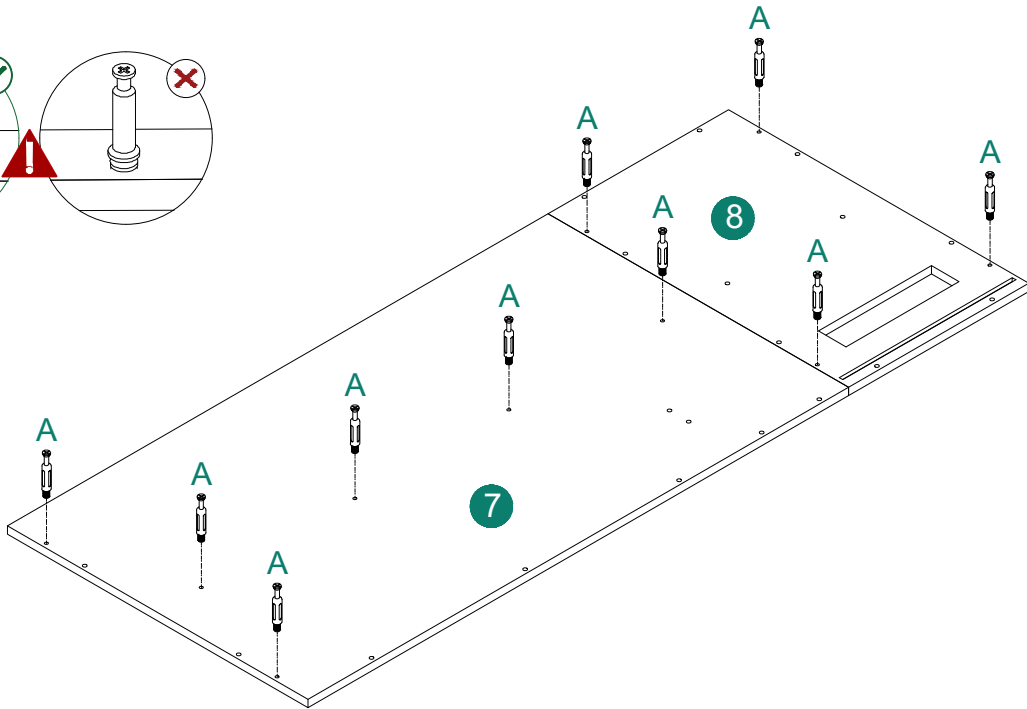
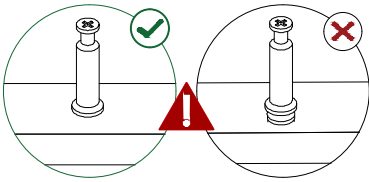

Ⓐ 10pcs



10

Ⓑ 10pcs Ⓒ 6pcs



EN: Two people are needed to install it
 DE: Zur Installation werden zwei Personen benötigt
 FR: L'installation nécessite deux personnes
 IT: Per l'installazione sono necessarie due persone
 ES: Se requieren dos personas para la instalación

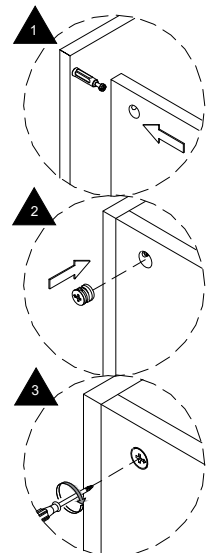
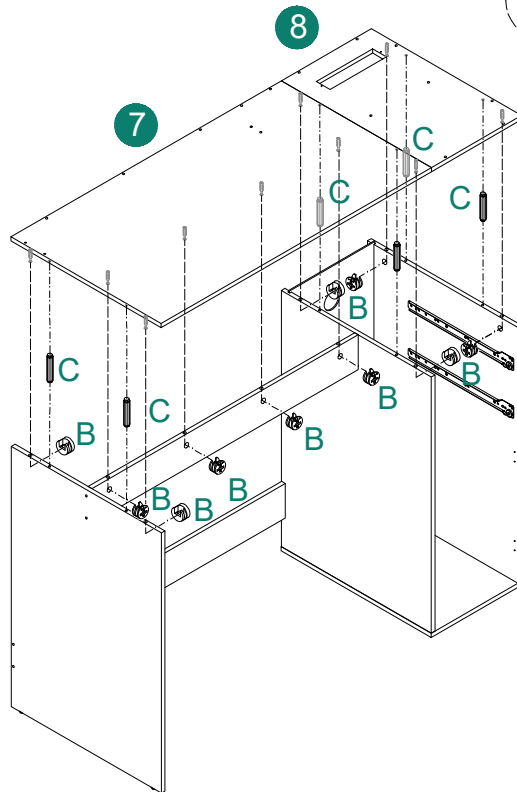
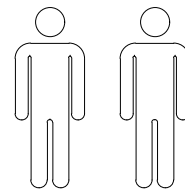

11

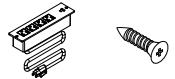

Ⓚ1pc ⓔ2pcs

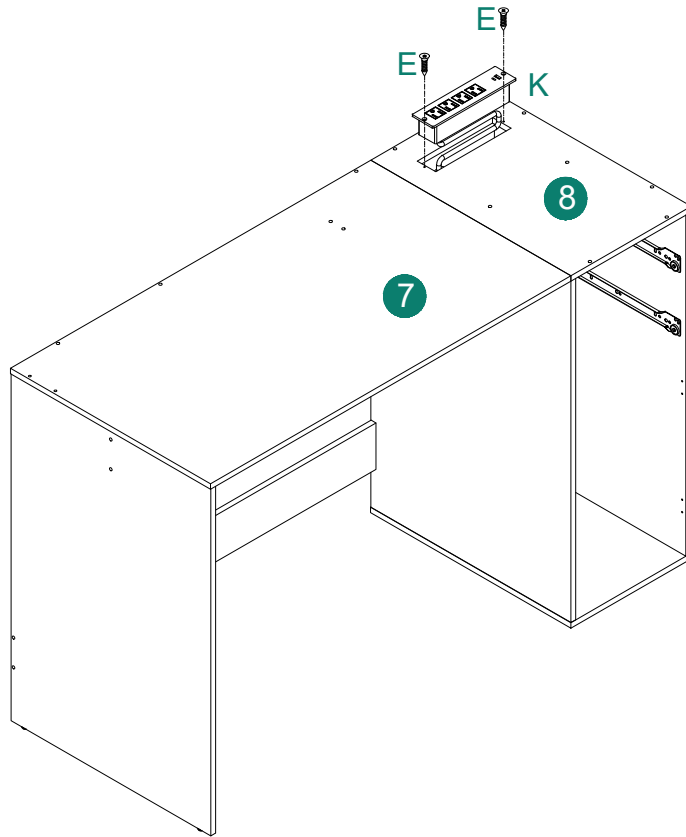

12

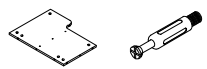

⓫1pc ⓐ2pcs

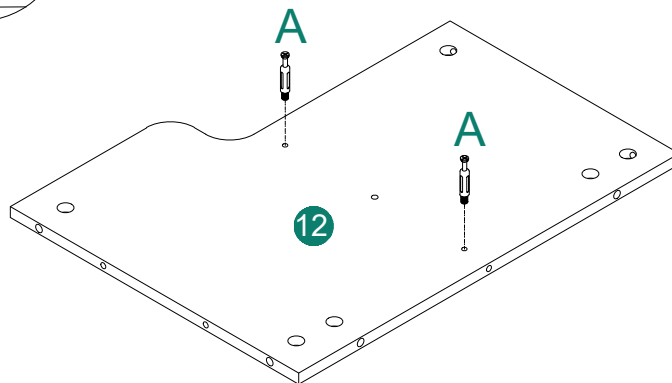
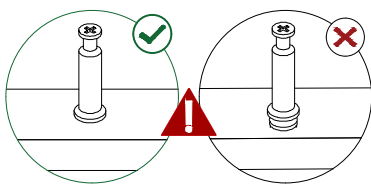

13

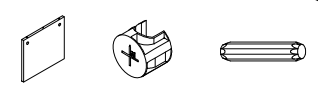

⑬1pc ①2pcs ②1pc

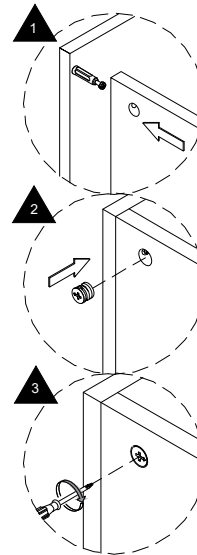
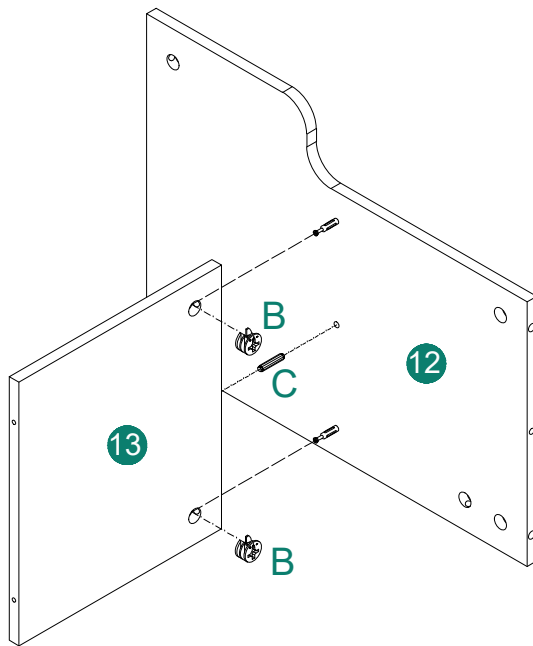

14

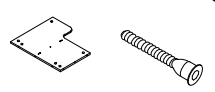

⑭1pc ①2pcs

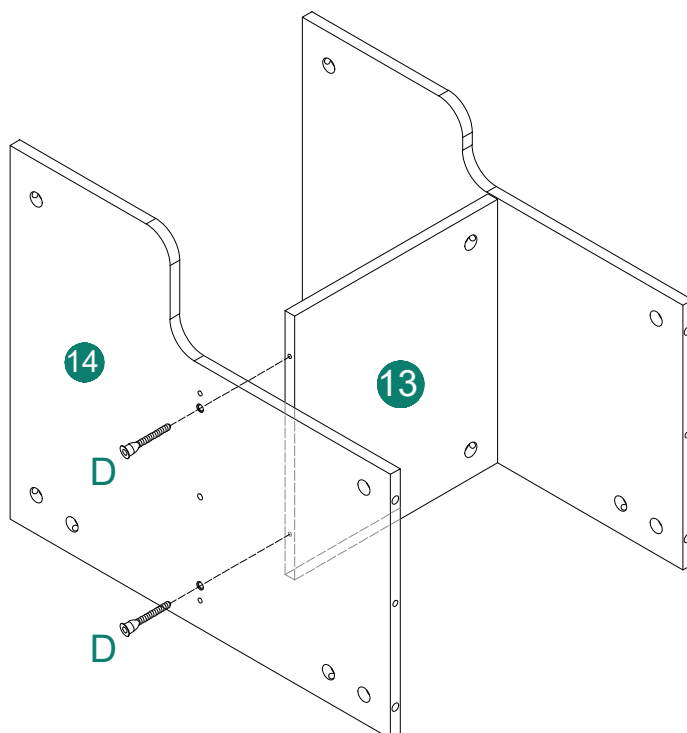

15



Ⓐ 2pcs

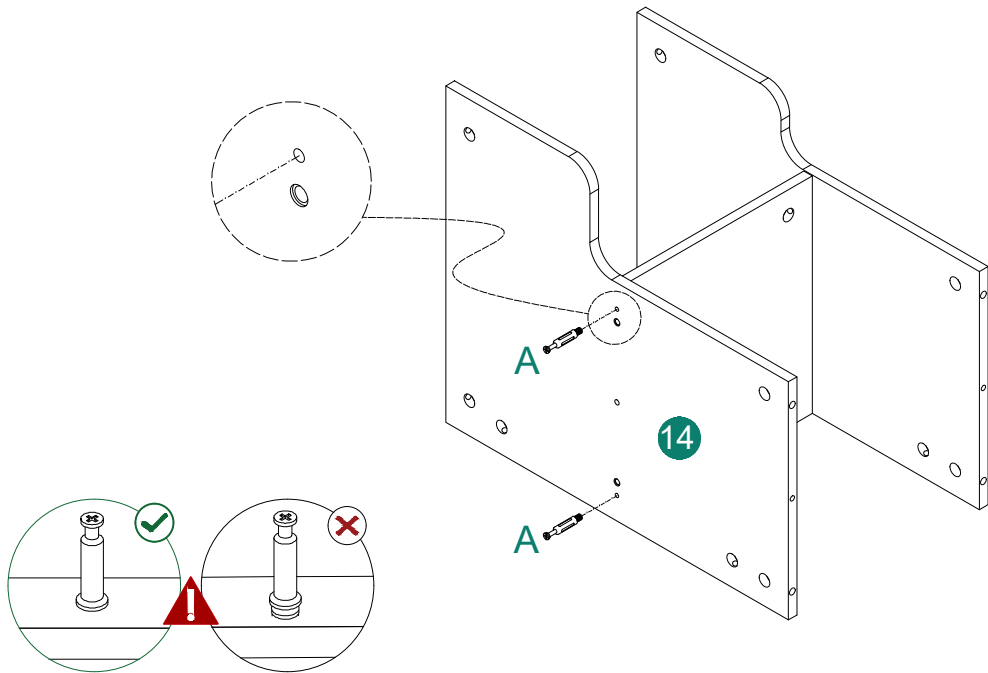

16



Ⓒ 1pc



Ⓑ 2pcs



Ⓒ 1pc

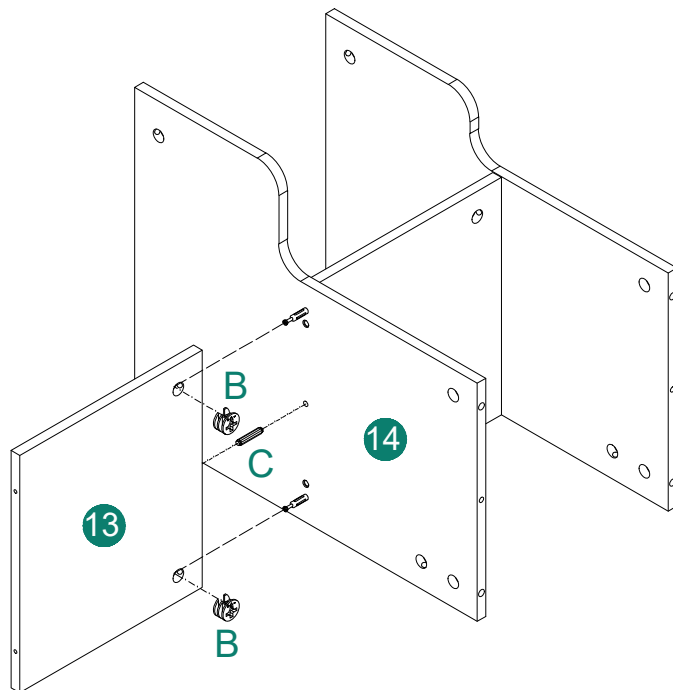

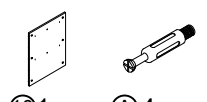
17 
 ⑩1pc ①A4pcs

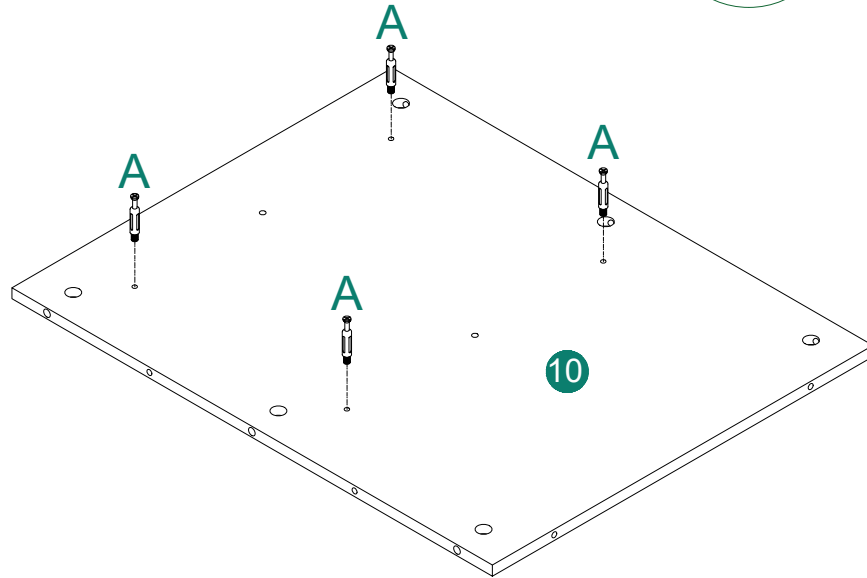
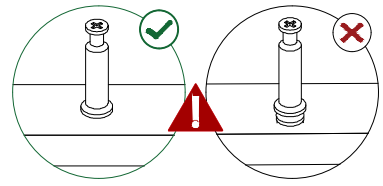

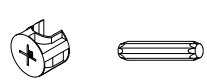
18 
 ③B4pcs ②C2pcs

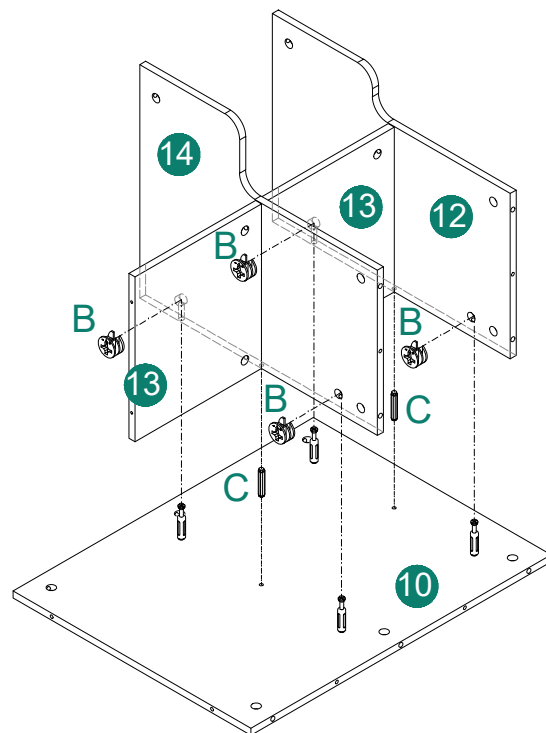

19

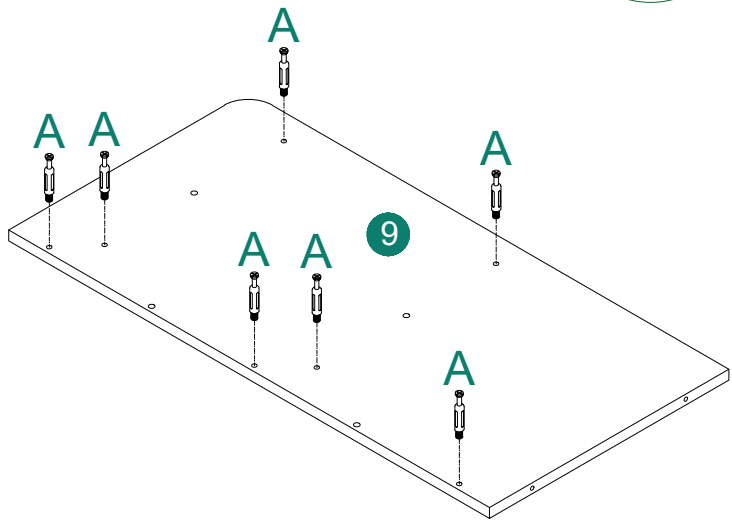
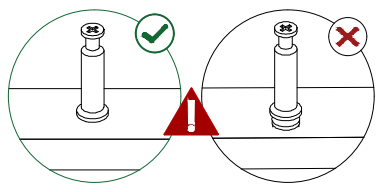
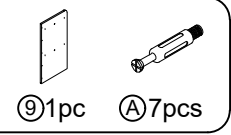

20

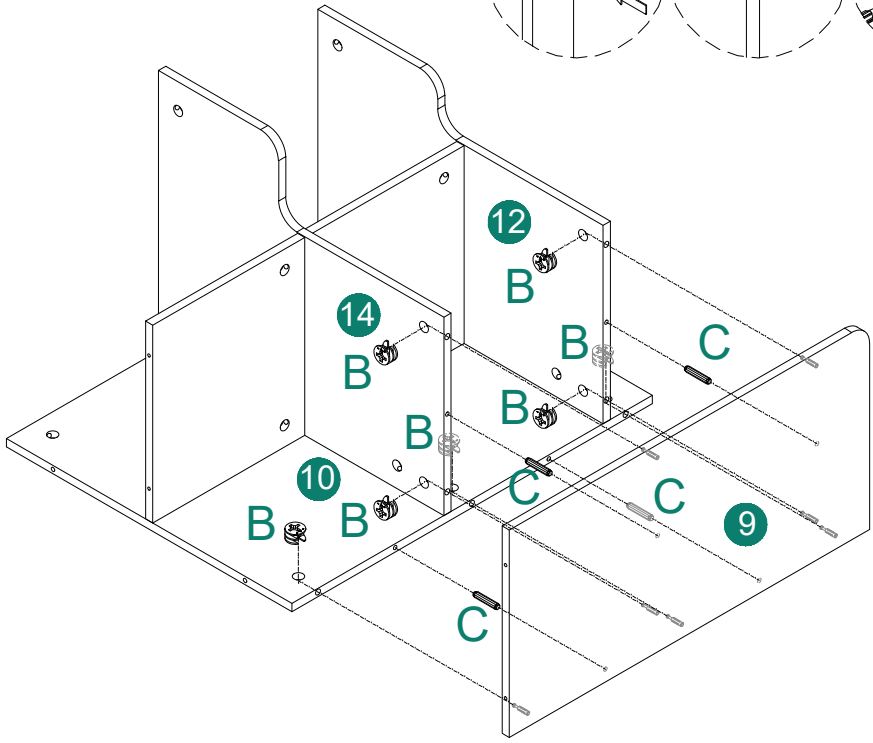
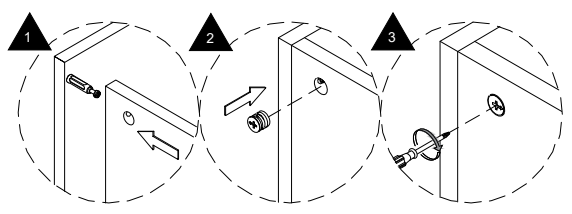
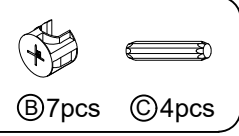

23



©2pcs



Ⓓ8pcs

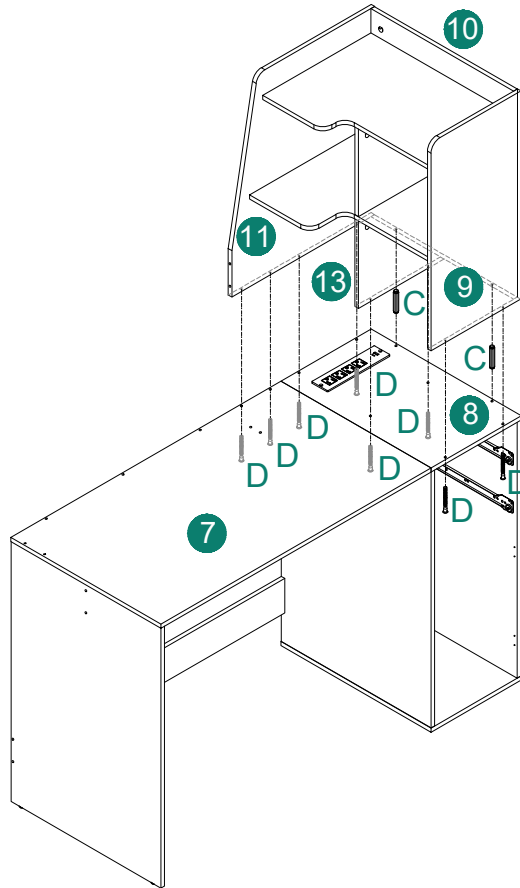

24



Ⓘ1pc



©2pcs

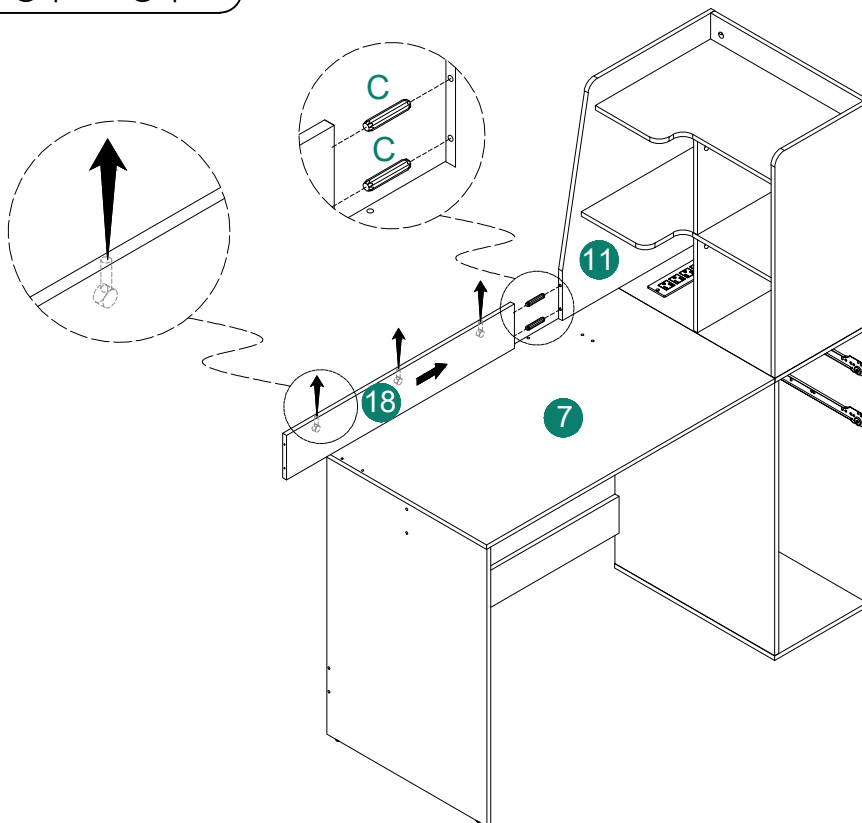

25



Ⓐ 2pcs Ⓓ 3pcs

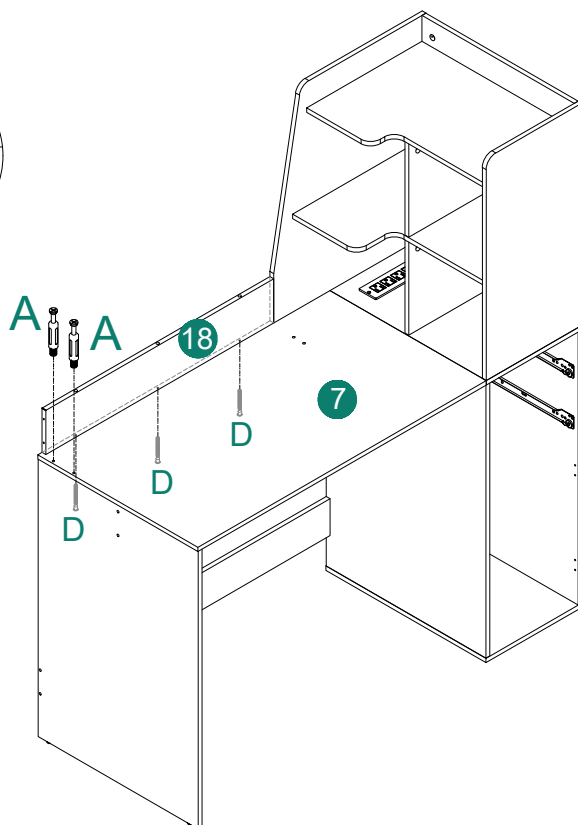
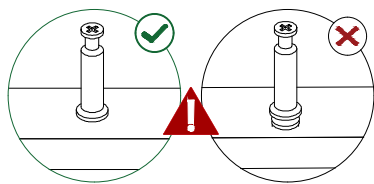

26



Ⓐ 1pc Ⓑ 1pc Ⓒ 2pcs Ⓓ 4pcs

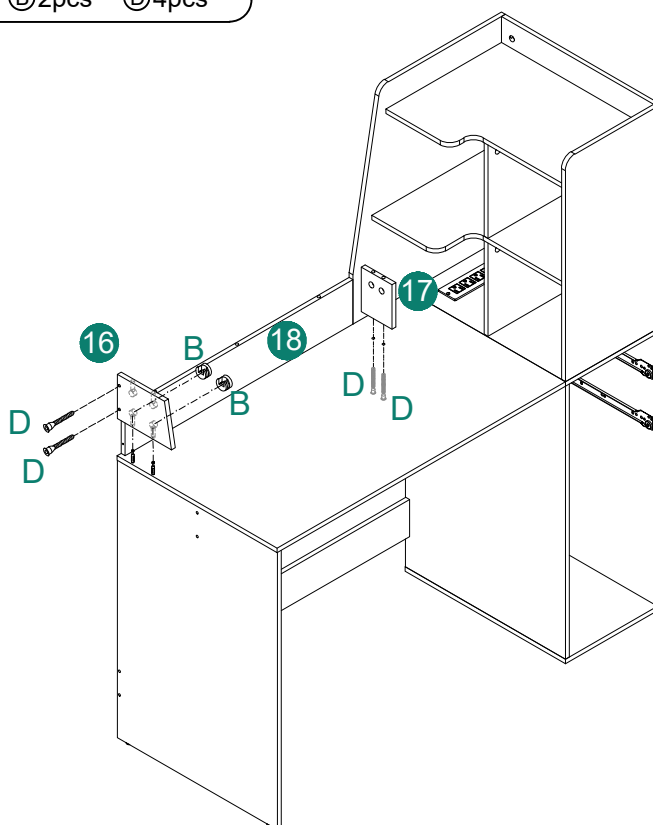

27



⑮1pc



Ⓔ6pcs



Ⓝ3pcs



Ⓜ1pc

Please note that the USB interface is on this side

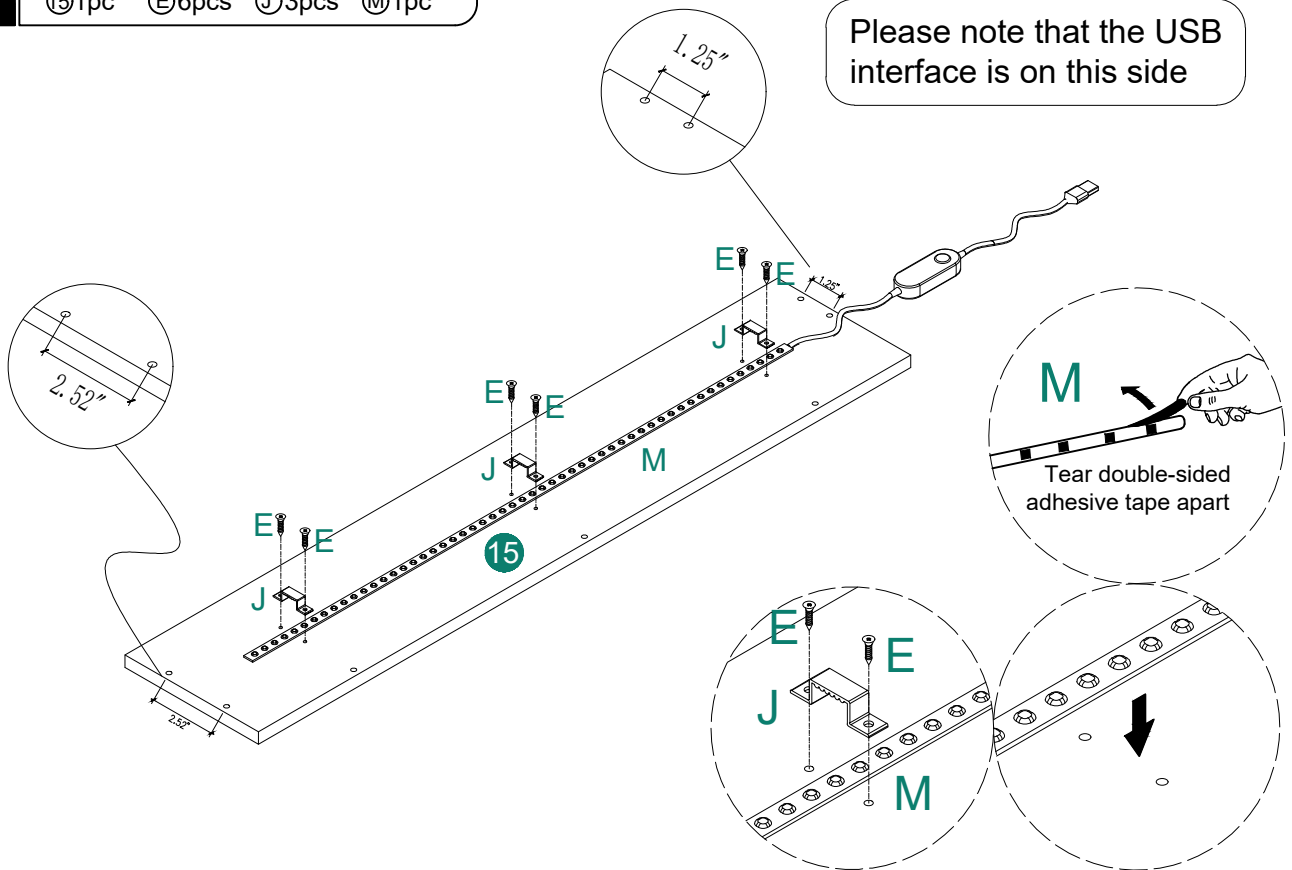

28



Ⓐ7pcs

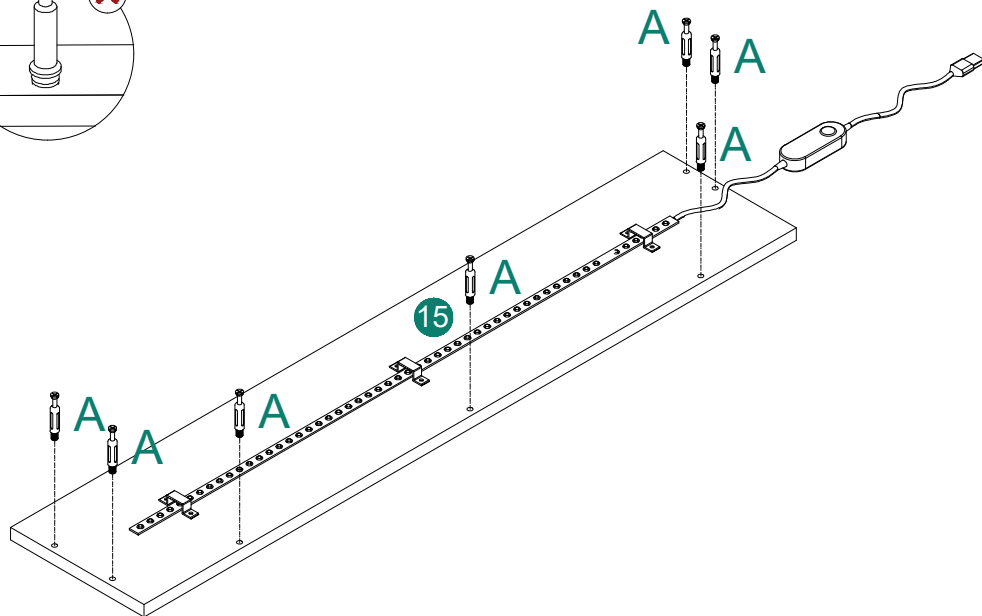
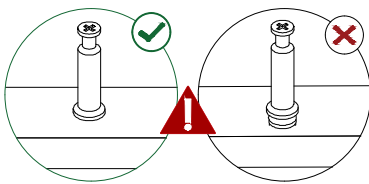

29

ⓑ 7pcs

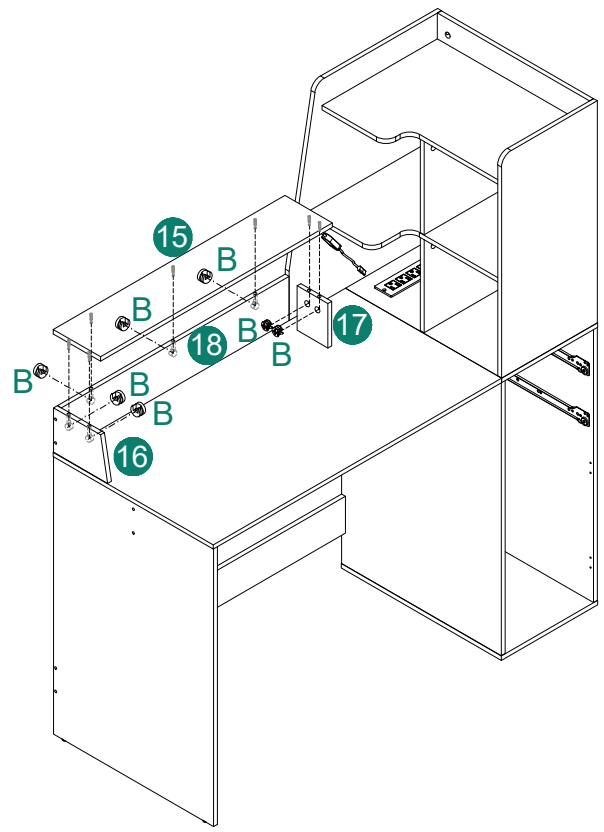
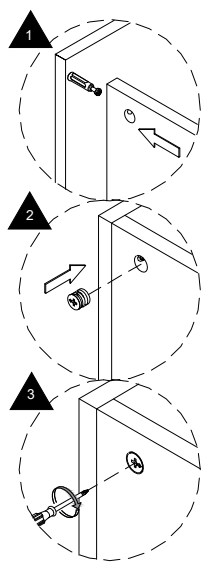



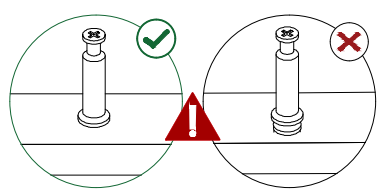
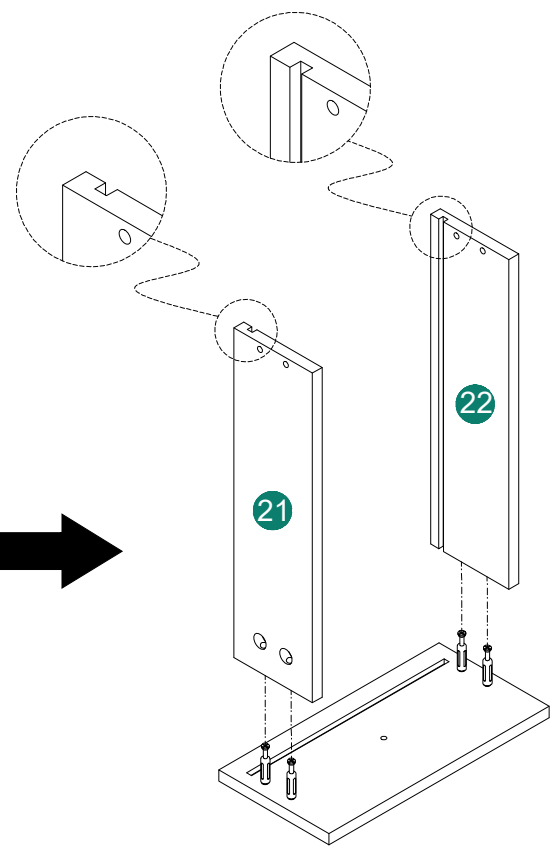
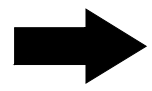
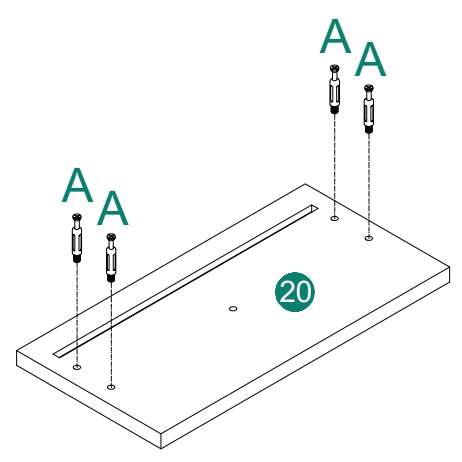

30

ⓐ 2pcs ⓑ 2pcs ⓒ 2pcs ⓓ 8pcs



x2



31

23 2pcs 24 2pcs B 8pcs D 8pcs

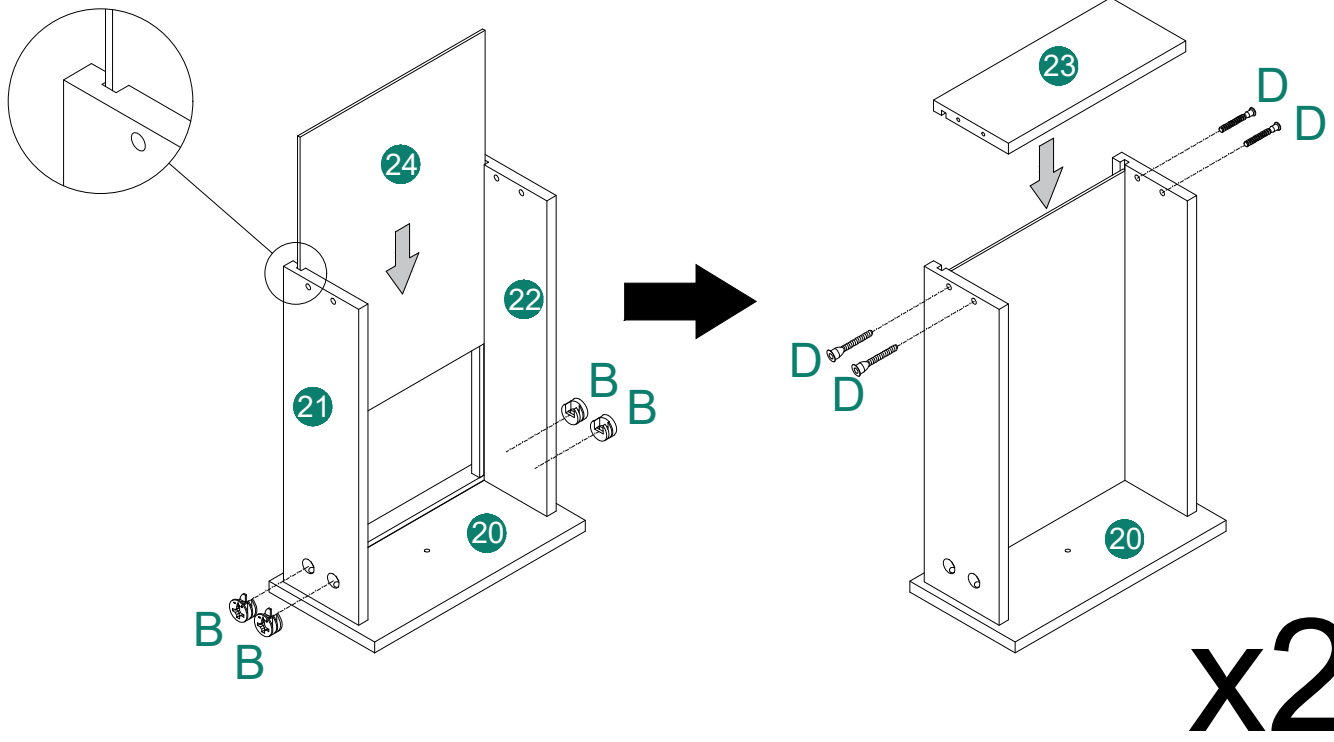
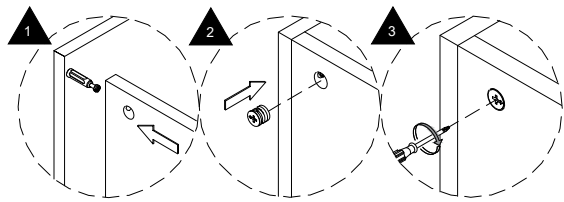

32

E 8pcs DR DL F 2pcs

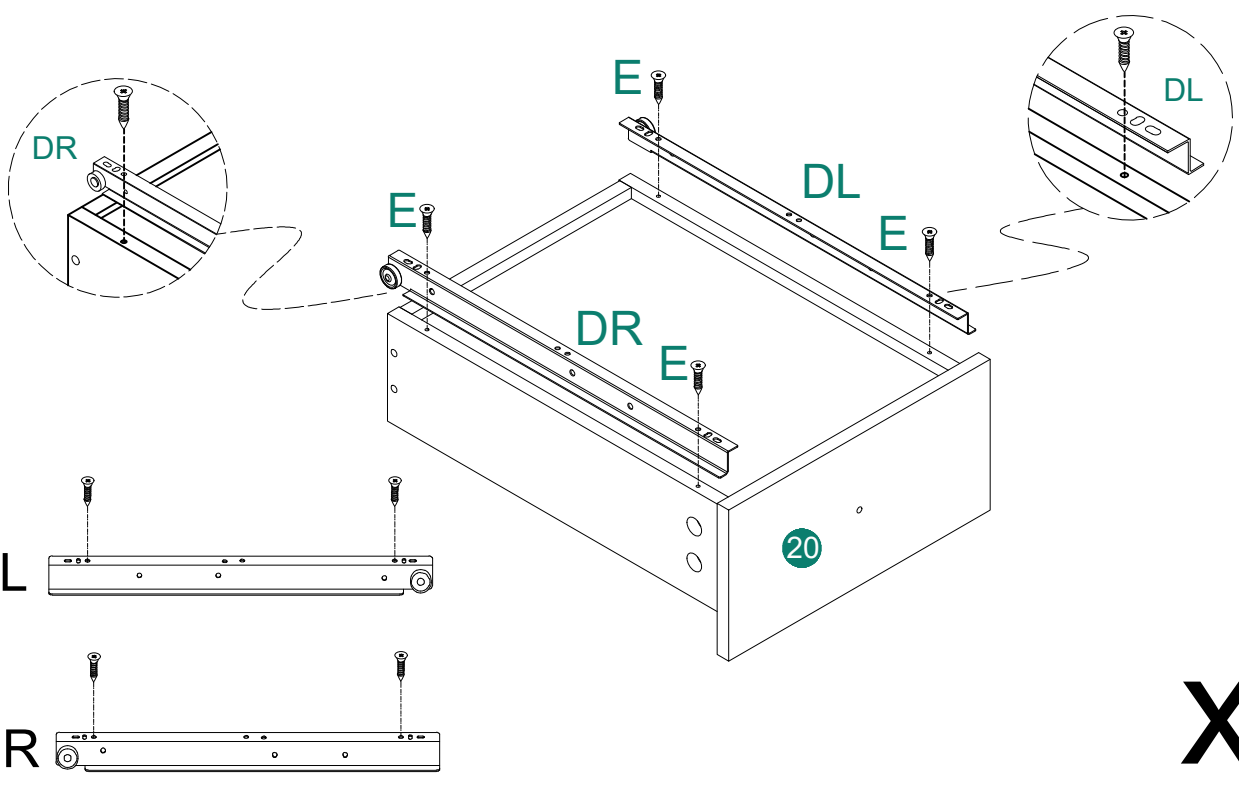

33

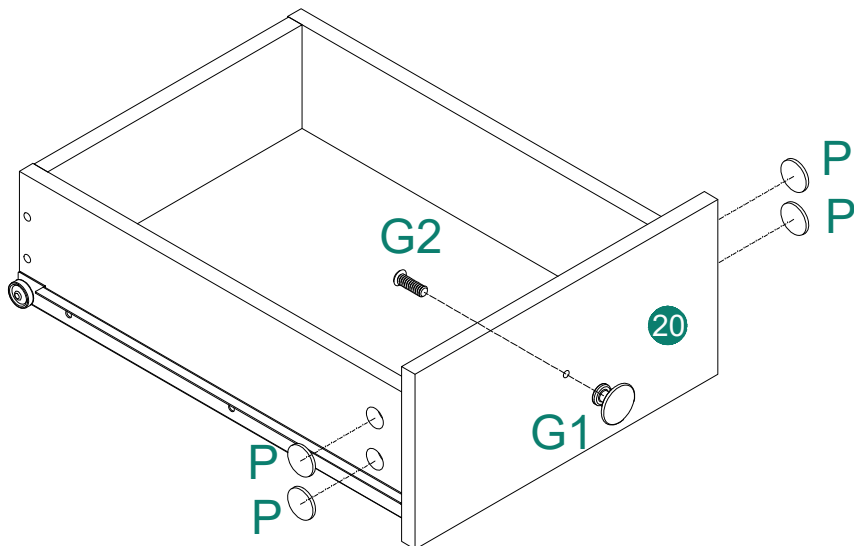
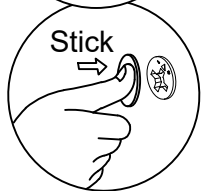
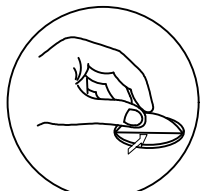

x2

34

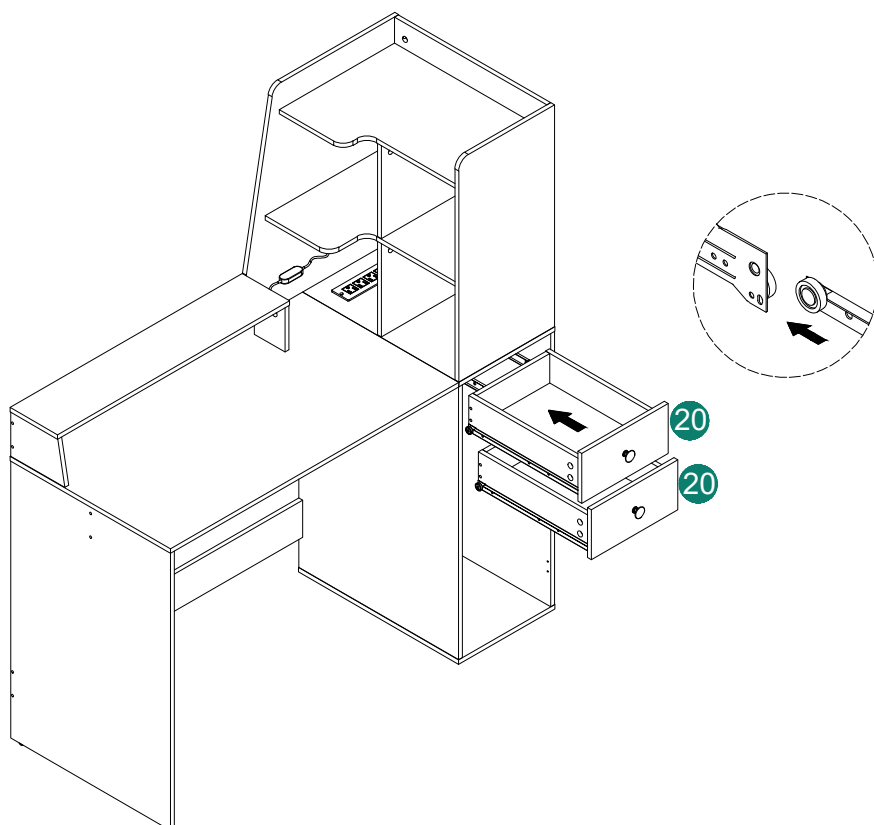

35

①9 1pc ②E 6pcs ③H 2pcs ④L2 1pc

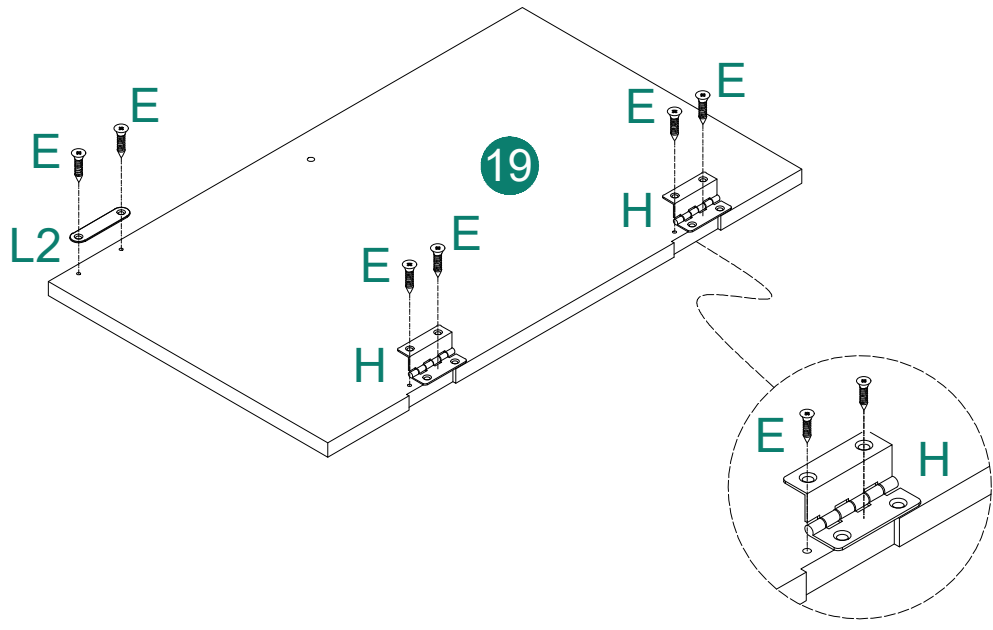



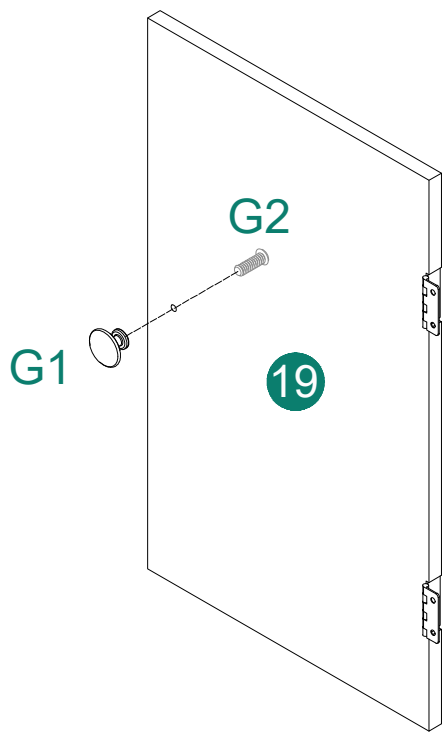

36

①G1 1pc ②G2 1pc

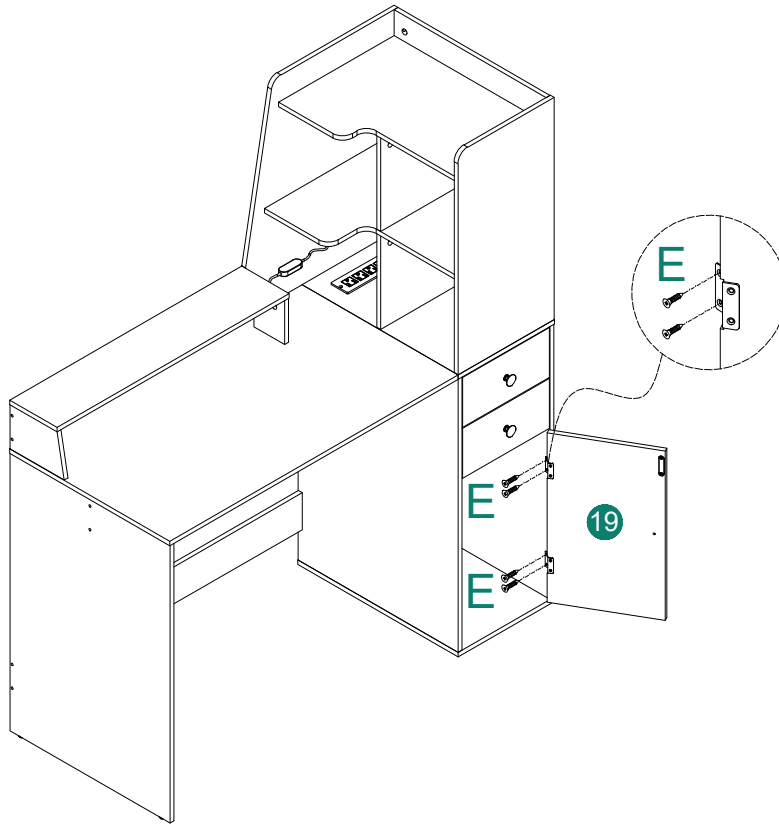

37  **E**4pcs



38   
N6pcs **Q**6pcs **P**3pcs

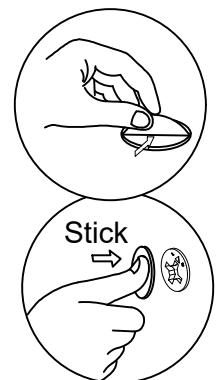
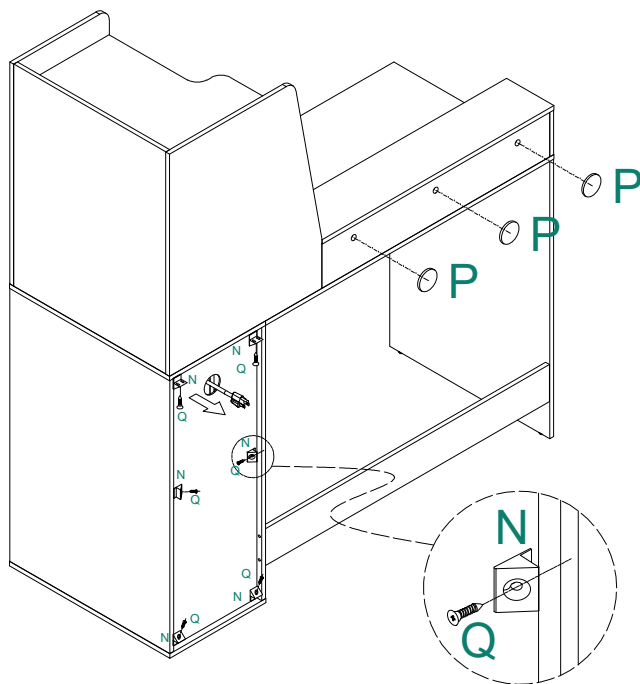

39



Ⓞ1pc

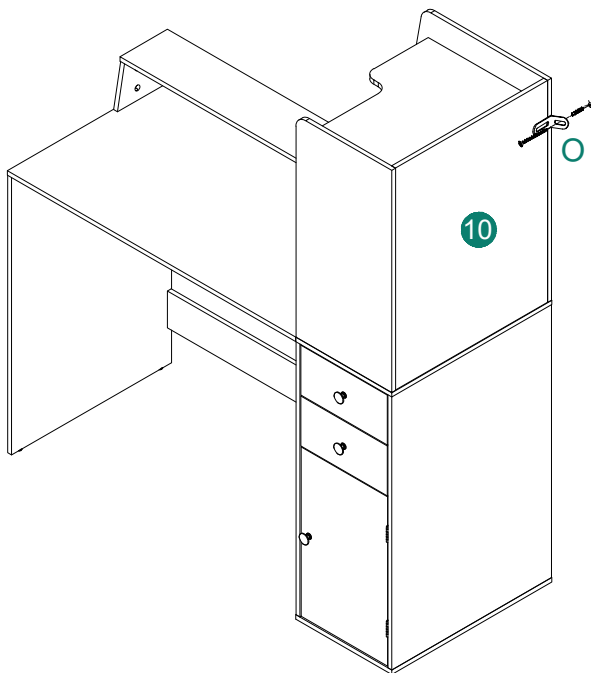

- STEP1
- STEP2
- STEP3
- STEP4
- STEP5

40



Ⓞ22pcs

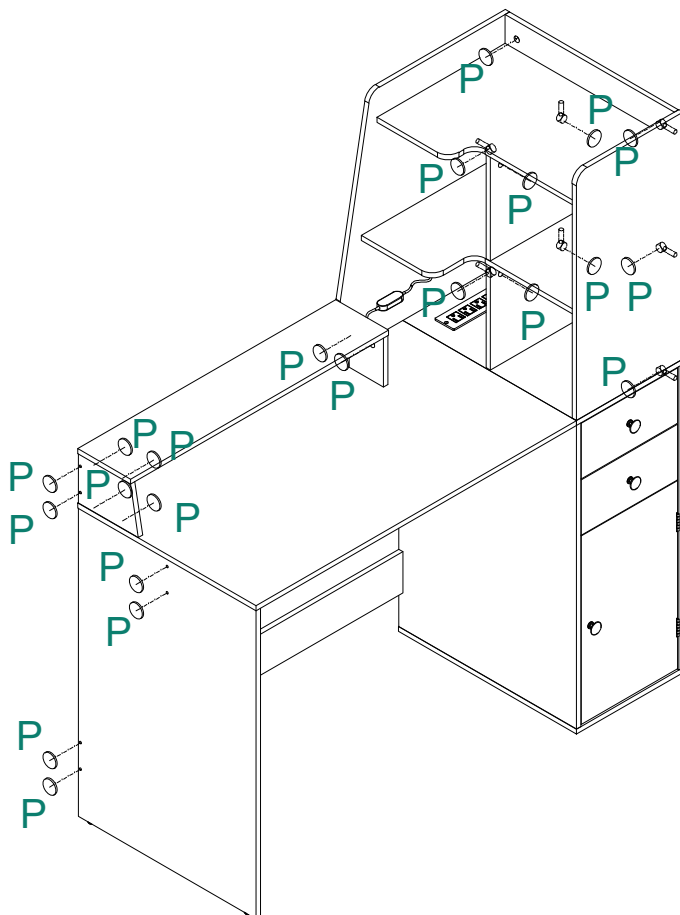
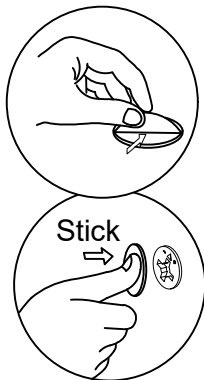

41

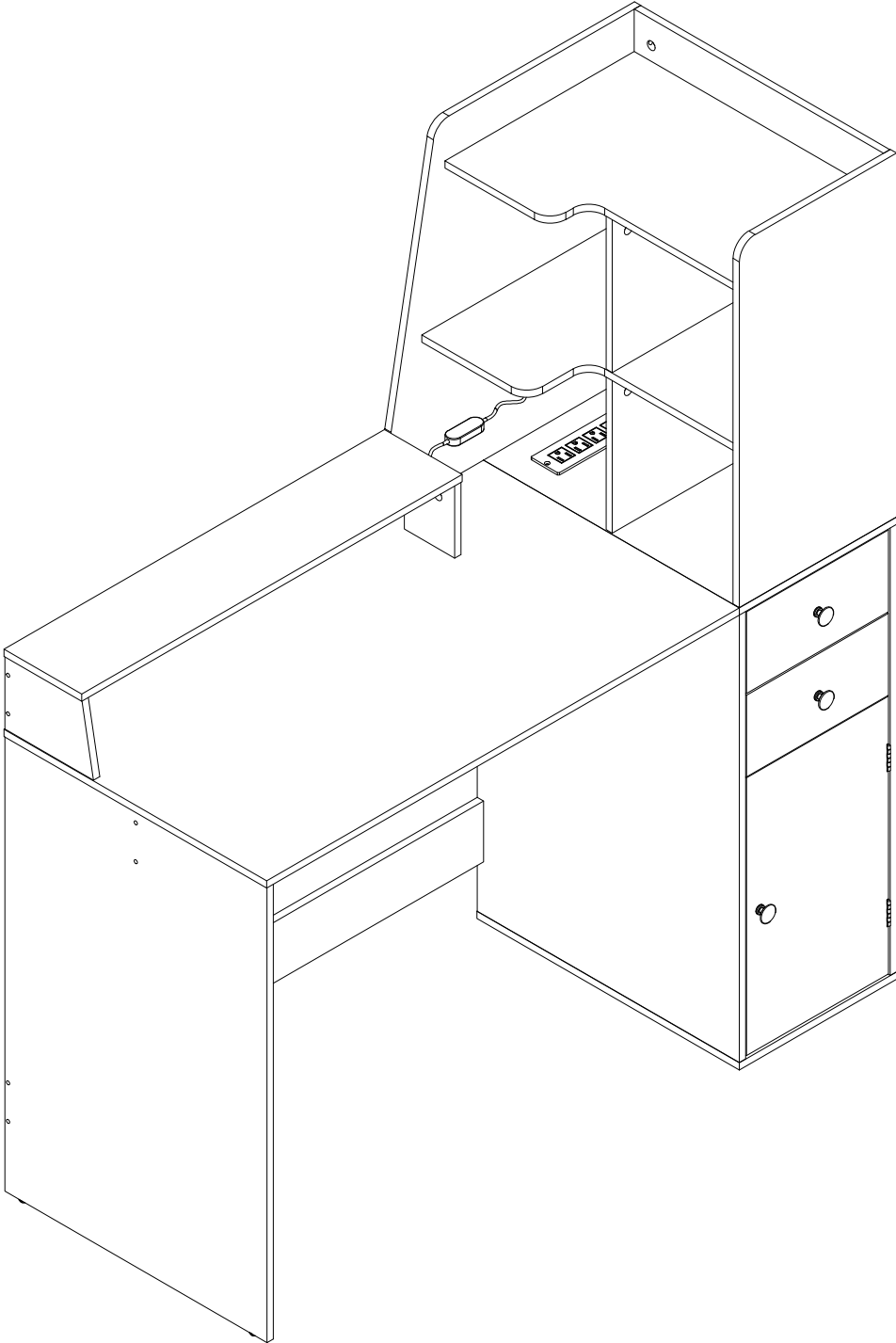

Installation Completed