

# ASSEMBLY INSTRUCTIONS

## ROUND DINING TABLE

### TOOLS REQUIRED

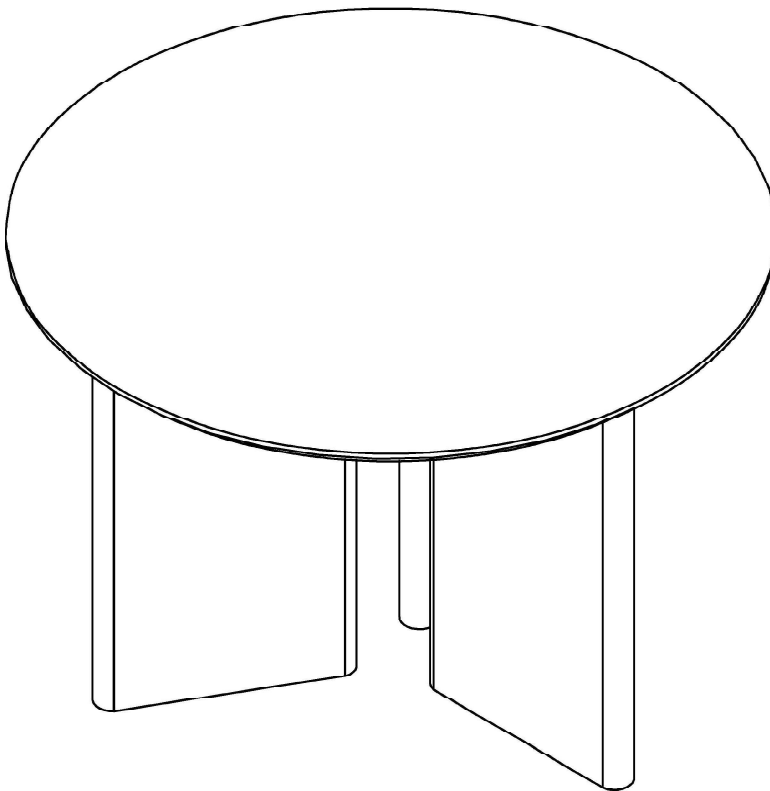

**Screwdriver**  
(Not included)



**Allen key**  
(Included)

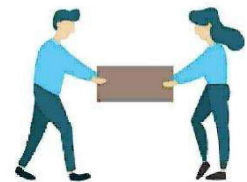

**2 - People**

Enjoying this product? We'd love your 5-star review!  
If you have any issues, our support team is happy to help.

Thank you for your purchase

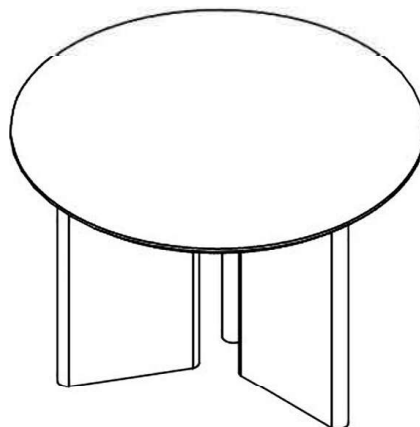

**✓ CHECK  
BEFORE STARTING**

Are you missing anything?

Please double check all hardware and parts match the assembly guide before putting the product together. If damaged, we suggest you put the item back in the box and start your claim or return

Should we send any replacements?

If there are any manufacturer defects or missing pieces please contact us for replacements. If purchased online, please contact the website of where you purchased it from, DIRECTLY

**IMPORTANT INFO before assembly:**

If there's a problem with the parts do not attempt to assemble the product

- . Place all parts on a clean and smooth surface such as a rug/carpet to avoid parts from being scratched
- . When tightening screws to product do not overtighten until product is fully setup
- . If product is too heavy for a single person to carry do not attempt and ask for assistance
- . DO NOT DRAG or PUSH item to desired location. Must be carried when moving
- . If item is not working as intended please review the assembly guide to see if any steps were missed or incorrectly built. If there's a problem with part please contact seller for additional assistance
- . Please keep all hardware and small parts away from pets/infants
- . Please wear gloves or protective gear to protect from getting cuts
- . It is normal for new furniture to have an off gassing smell. Please air out furniture near a window for a few hours or a day before placing it in its desired location
- . All products may have a slight color and texture variation due to different shipments, natural materials, screen- resolutions, or lighting in home. Images are rendered by different devices or websites

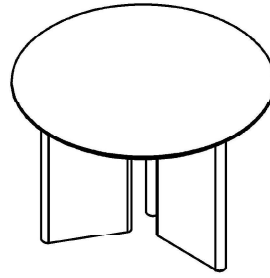

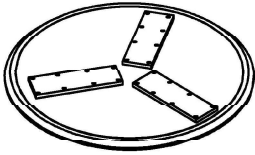
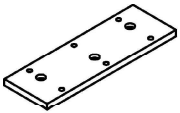
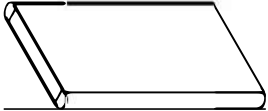

## ROUND DINING TABLE

### PARTS LIST

|  |   |   |
|--|---|---|
| <p><b>A</b></p>  <p>Table Top = 1pc</p> | <p><b>B</b></p>  <p>Connecting panel = 3 pcs</p> | <p><b>C</b></p>  <p>Table legs = 3 pcs</p> |
|  |   |   |

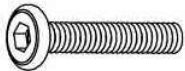
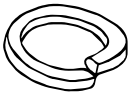
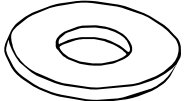
### HARDWARE LIST

|  |  |   |
|--|--|---|
| <p><b>1</b></p>  <p>5/16" x 38mm Hex Button Head Bolt =27 pcs</p> | <p><b>2</b></p>  <p>5/16" Lock Washer= 27 pcs</p> | <p><b>3</b></p>  <p>5/16" x D19 Flat Washer = 27 pcs</p> |
| <p><b>4</b></p>  <p>Allen Key K4 =1pc</p>                         |  |   |
|  |  |   |

## ROUND DINING TABLE

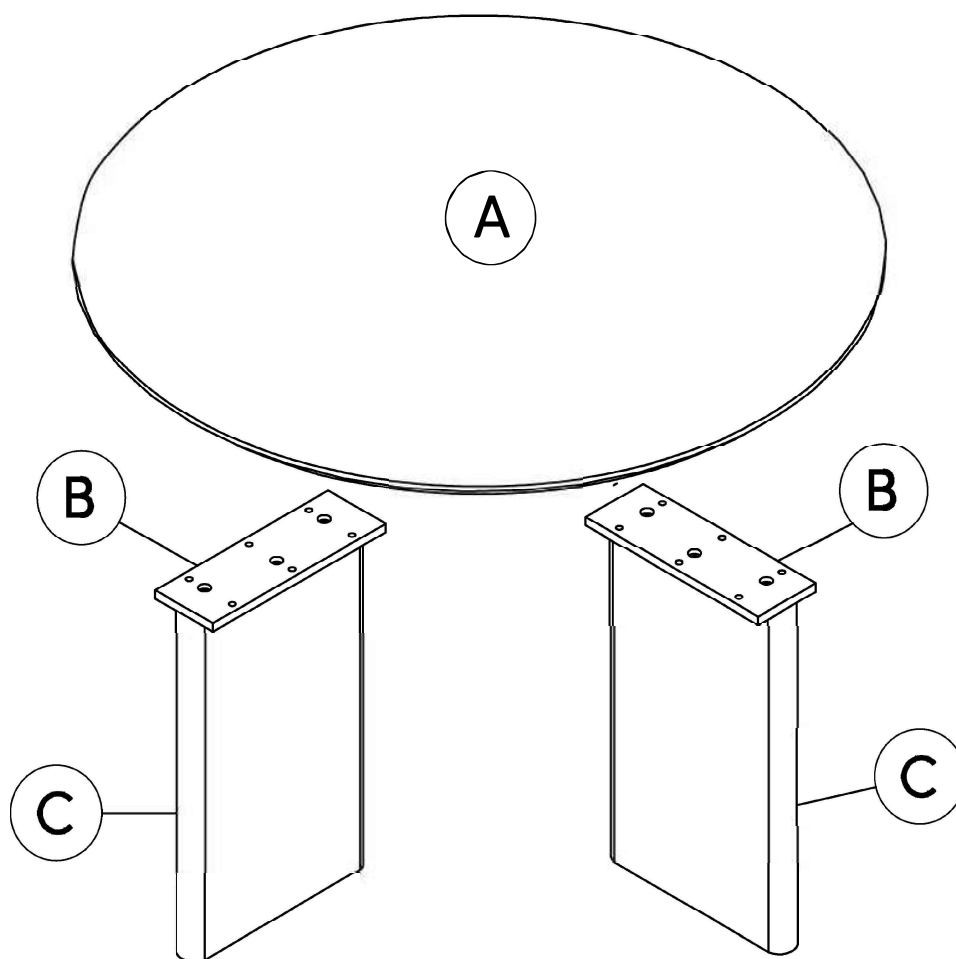
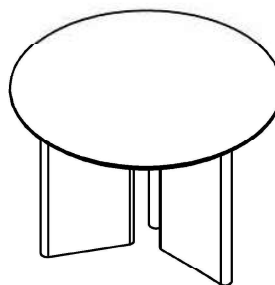



1. Do not tighten bolts / screws completely until all bolts / screws are lined up and inserted into holes.
2. Do not over tighten screws and bolts to avoid stripping.
3. Please use hand tools to assemble this product.

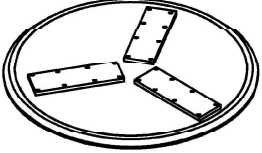
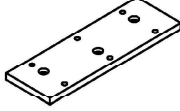

# PARTS

check that you've received all parts listed below

## PARTS LIST

|  |   |   |
|--|---|---|
| <p><b>A</b></p>  <p>Table Top = 1pc</p> | <p><b>B</b></p>  <p>Connecting panel = 3 pcs</p> | <p><b>C</b></p>  <p>Table legs = 3 pcs</p> |
|  |   |   |

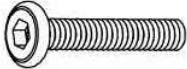
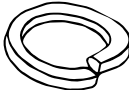
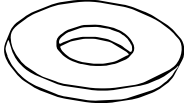
## HARDWARE LIST

|  |  |   |
|--|--|---|
| <p><b>1</b></p>  <p>5/16" x 38mm Hex Button Head Bolt =27 pcs</p> | <p><b>2</b></p>  <p>5/16" Lock Washer= 27 pcs</p> | <p><b>3</b></p>  <p>5/16" x D19 Flat Washer = 27 pcs</p> |
| <p><b>4</b></p>  <p>Allen Key K4 =1pc</p>                         |  |   |
|  |  |   |

**Step 1** Begin securing the Connecting panel (B) to the Table legs (C) using the 5/16 inch Flat Washer (3), 5/16 inch Lock Washer (2) and 5/16 x 1 1/2 inch Hex Button Head Bolt (1).

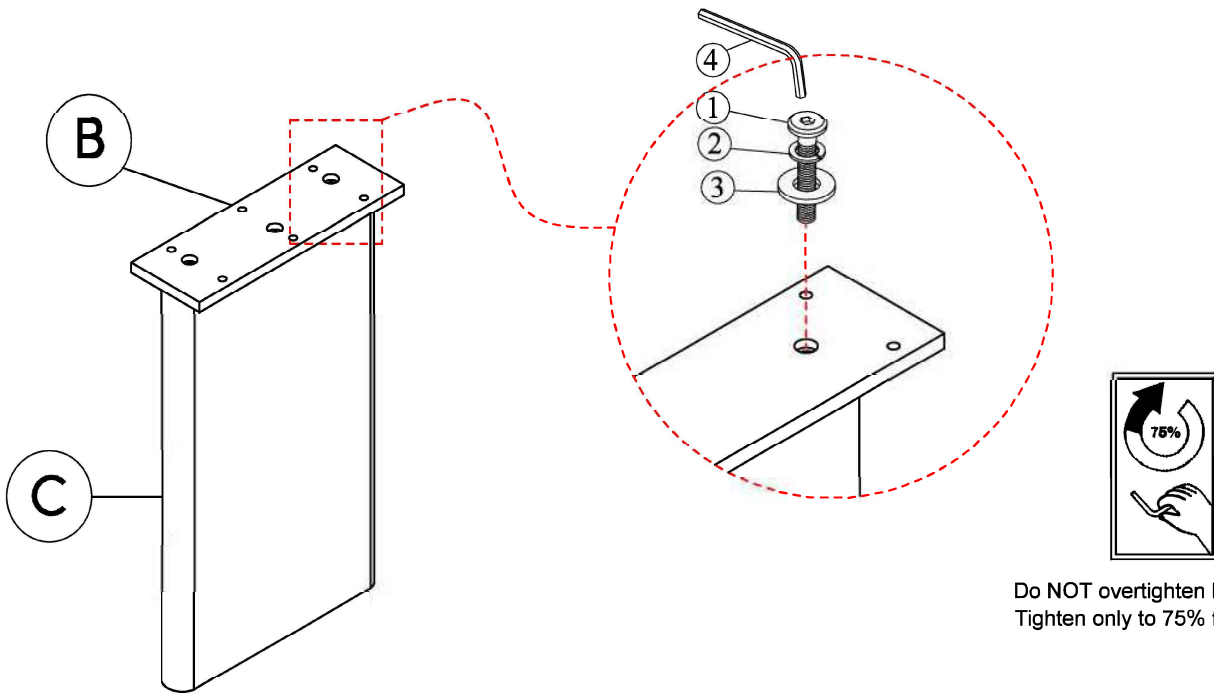

Do NOT overtighten hardware.  
Tighten only to 75% for now.

## Step 2

Finish securing the Table top (A) to the Table legs (C) using the Flat Washers (3), Lock Washers (2) and 5/16 x 1 1/2 inch Hex Button Head Bolts (1).

Tighten to 75% using the Allen Key (4).

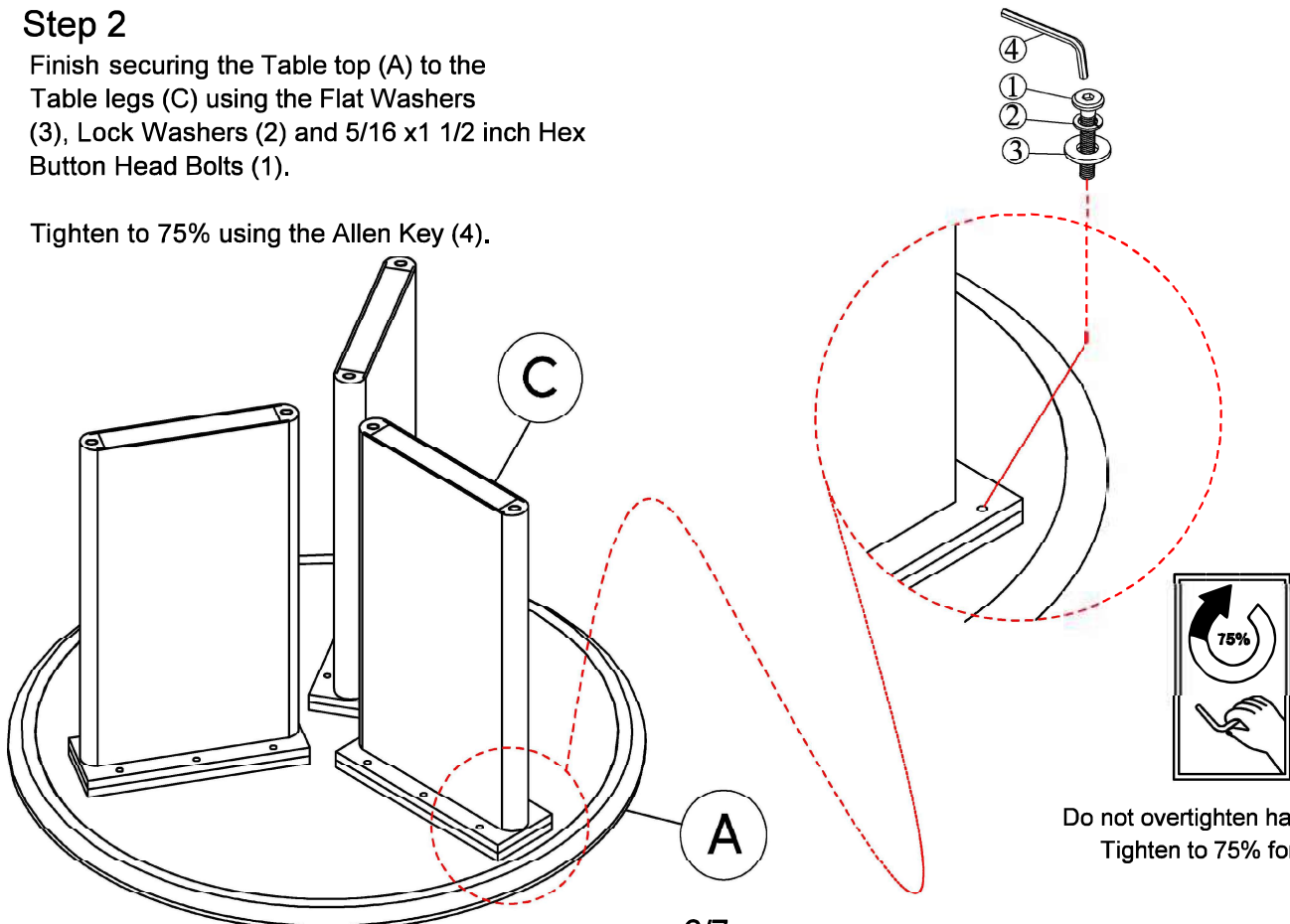

Do not overtighten hardware.  
Tighten to 75% for now.

### Step 3

Lastly, double-check that your table is level & stable. If it's looking a little unlevel or unstable still, you can adjust the levelers on each of the front legs.

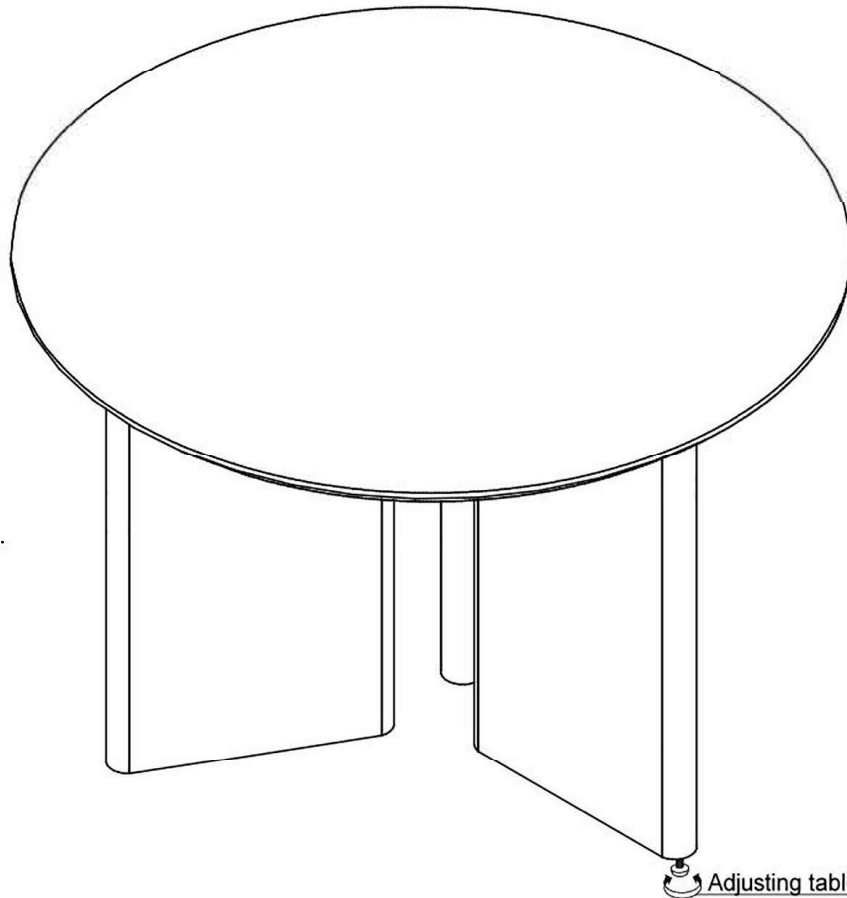

**HELPFUL TIP:**  
Adjust the levelers to help  
balance the table, if need be.