

INSTRUCTION MANUAL

Electric Fireplace

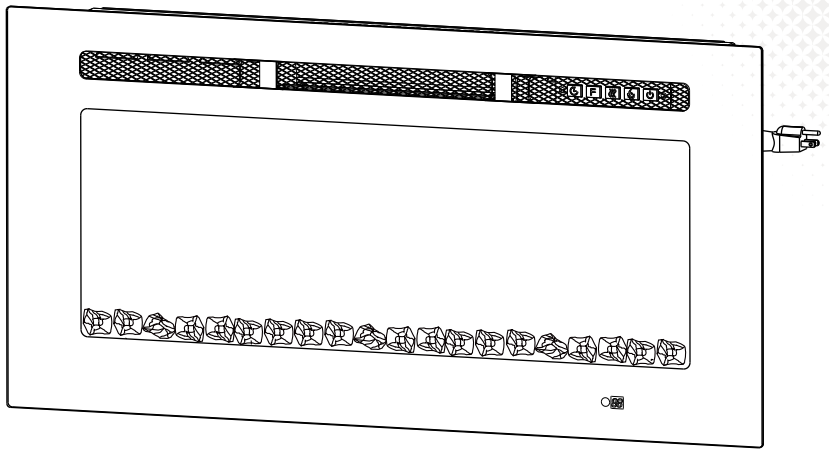

Intertek

Oneinmil furniture

We are a professional furniture provider with top-notch factories and outstanding designs, Our mission is to provide consumers with new lifestyles. By collecting consumer feedback, we constantly improve our products and create more choices for consumers.

If you want to create your space,

We are an ideal choice.

————— Always. —————



WARNING

READ THIS MANUAL
BEFORE INSTALLING
AND OPERATING
THIS APPLIANCE.



WARNING

FAILURE TO FOLLOW
THESE INSTRUCTIONS
MAY RESULT IN
ELECTRIC SHOCK,
FIRE PROPERTY,
OR PERSONAL INJURY.



WARNING

**DO NOT STORE OR USE
GASOLINE OR OTHER
FLAMMABLE LIQUIDS
IN VICINITY OF THIS
APPLIANCE.**

ONEINMIL

IMPORTANT SAFETY INFORMATION!

⚠ WARNING

1. **Read all instructions before using this heater!**
2. This heater is hot **when in use**. To avoid burns, **DO NOT** let bare skin touch hot surfaces. If provided, use handles when moving this heater. Keep combustible materials, such as furniture, pillows, bedding, papers, clothes, and curtains at least **3 feet (0.9m)** from the front of the heater, and **keep them away from the sides and rear**.
3. **Extreme caution** is necessary when any heater is used by or near children or invalids and whenever the heater is left **operating and unattended**.
4. **DO NOT** operate any heater with a **damaged cord or plug** or after the **heater malfunctions**, has been **dropped or damaged in any manner**. Discard heater, or return to an authorized service facility for examination and /or repair.
5. **DO NOT** run power cord under carpeting.
6. **DO NOT** cover power cord with throw rugs, runners, or similar coverings.
7. **DO NOT** route power cord under furniture or appliances. Arrange power cord away from **traffic area**, and where it will not be tripped over.

⚠ WARNING

1. **Connect to properly grounded outlets ONLY.**
2. **DO NOT** insert or allow foreign objects to **enter any ventilation or exhaust openings**, as this may cause **electric shock** or fire, or **damage the heater**.
3. To prevent a possible fire, **DO NOT** block air intakes or exhaust in any manner. Doing so could cause a fire. **DO NOT** use on soft surfaces, like a bed, where openings may become blocked.
4. A heater has **hot and arcing or sparking parts inside**. **DO NOT** use it in areas where **gasoline, paint, or flammable liquids** are used or stored.
5. **Use this heater only as described in this manual. Any other use not recommended by the manufacturer may cause fire, electric shock, or injury to persons.**
6. **ALWAYS** plug heaters directly into a wall outlet/receptacle. **Never use an extension cord or relocatable power tap (outlet/power strip).**
7. **DO NOT** place the heater near a bed because objects such as pillows or blankets can fall off the bed and be ignited by the heater.
8. **NEVER** use this heater in **bathrooms, laundry rooms**, or any other location where the heater could fall into a **bathtub or pool, become damp, or come in contact with water**.
9. **AVOID FIRE!** Regularly inspect all air vents to make sure they are free from dust, lint, or other Blockage. **Unplug the unit** and clean with a **vacuum ONLY**. **DO NOT** rinse or get wet.

⚠ WARNING

10. **ALWAYS** mount to wall bracket before use. **DO NOT** set on the floor, or other surface, to use.
11. **NEVER** use a wall mount bracket from another manufacturer.
12. This product is **not intended** to be a **primary heat source**. It is for **supplemental heat only**.
13. **INDOOR use only! NEVER** use this heater **outdoors!** Doing so may result in **electric shock!**
14. **Risk of electric shock! DO NOT OPEN!** No user-serviceable parts inside!
15. **ALWAYS** turn this heater off before unplugging it from the outlet.
16. **ALWAYS** disconnect this unit from the **power** supply **before** performing any assembly or cleaning, or before relocating the electric fireplace.
17. **NEVER** leave this heater unattended. **ALWAYS** unplug this heater when not in use.
18. **ALWAYS** store this heater in a dry location. **NEVER** use the fireplace if it has become wet.
19. **NEVER** plug this heater into an outlet that is **old, cracked,** or has any **loose wires or connections**. Plugging this heater into a faulty outlet could result in **electric arcing** within the outlet that could cause the **outlet to overheat or catch fire**.
20. **ALWAYS** check your heater cord and plug connections with **each use!**
 - i) **MAKE SURE** the plug fits tightly in the outlet! Faulty wall outlet connections or loose plugs can cause the outlet to overheat.
 - ii) **Heaters draw more current** than small appliances. **Overheating** may occur even if it has not occurred with the use of other appliances.
 - iii) During use **check frequently** to see if the plug outlet or **faceplate** is **HOT!**
 - iv) If the outlet or faceplate is **HOT, discontinue use immediately** and have a qualified electrician inspect and/or replace the faulty outlets.

TOOLS REQUIRED



PHILLIPS
SCREWDRIVER



DRILL &
NO.6 DRILL BIT



PENCIL
& RULER

+ AAA - 2 AAA BATTERIES



LEVELER



2Persons Assembly



Minimum 30 Minutes For Assembly

PARTS & HARDWARE

A

Fireplace

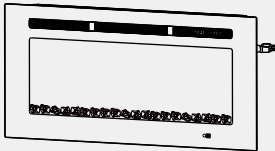

1PC

B

4PCS



4x12mm Screws

C

1PC



Remote Control

D

1BAG



Decorative Crystals

PRODUCT ASSEMBLY

Helpful Advice before Fitting

1. Please retain all packaging until you have checked and counted all the parts and the contents of the hardware pack against the parts list.
2. The hardware pack contains small items which should be kept away from young children.
3. We suggest that you open the hardware pack and place all the contents into a container, therefore reducing the risk of losing any small pieces.

Installation

1. Do not connect the appliance until properly fixed to the wall and the instructions are fully read.
2. The minimum distances must be observed in the diagrams.
3. For installation of the appliance, care must be taken not to damage concealed cables.
4. Please be careful while drilling the holes.

PRODUCT ASSEMBLY

Manual Operation

The switches located at the center right hand side of the fire .The standby switch must be first switch on.

IMPORTANT: THESE INSTRUCTIONS SHOULD BE READ CAREFULLY AND RETAINED FOR FUTURE REFERENCE!

Manual Operation

The switches located at the center right hand side of the fire .The standby switch must be first switch on.

Mantel Insert Instructions

- 1 Remove four silver screws from the sides of the heater. Remove the tempered glass by lifting it from the lugs on the sides.

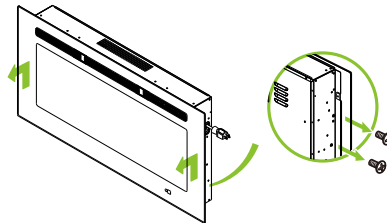

- 2 Take the glass from the appliance first, then gently put the appliance to the cut hole by two persons. Please see Fig.1

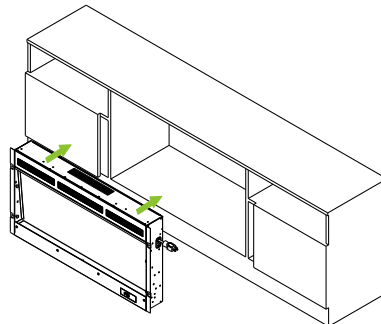

PRODUCT ASSEMBLY

- 3** For optimum viewing, mark the left and right screws (fixing positions on the wall in accordance with the appliance's holes; See Fig.2

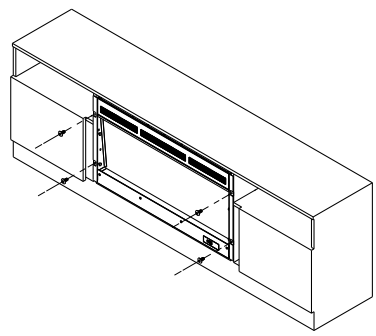

- 4** Place the front glass surround over the front of the fire aligning the slots in the bracket at each side of the glass panel with the lugs on the sides of the fire; See Fig.3
Again, two people will be required for this operation.

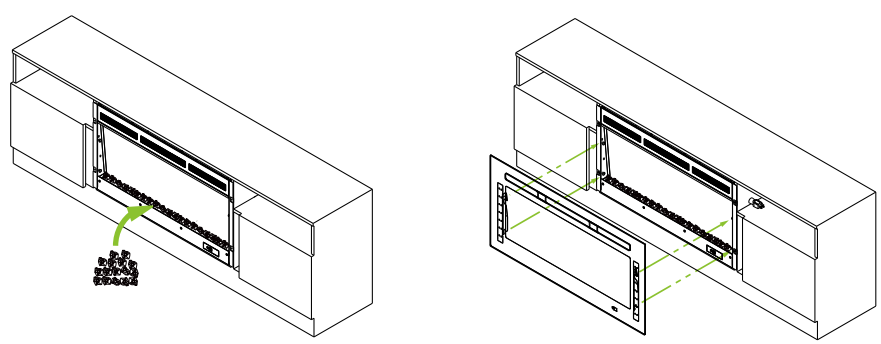

INSTRUCTIONS FOR USE

The appliance can be operated either by the switches located on the top right hand side of the fire or by supplied remote control.

TO ACCESS CONTROL PANEL

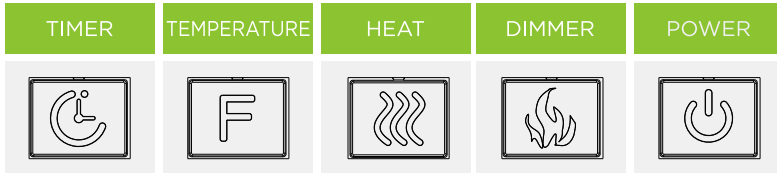

1. The standby switch located at the center right hand side of the fire must be first switch on.
2. It takes some time for the receiver to respond to the transmitter. Do not PRESS the buttons more than once within two seconds for correct operation.
3. Press once the button ON/OFF on the remote control this turns ON/OFF the appliance and fire effect.
4. **COLOR** button: Makes the color flame effect changing.
There are a total of 12 flame color effects.
After cycling through all 12 flame colors and pressing once more, it will enter the flame color loop mode.
Keep press 3 seconds Makes flame effect dimmer and brighter.
Press again until desired setting is reached.
Keep press 3 seconds Makes flame effect dimmer and brighter.
5. Press once the HEAT button for the low heat setting(750W); press twice for the high heat setting(1500W); press again to turn off the heater.
6. Temperature setting. The highest temperature of the thermostat is 82F. There are several thermostat levels you can cycle through between 62F and 82F, and the OFF settings.
7. Timer setting. Press the TIMER button to cycle through the timer settings (1Hour, 2H, 3H,4H,5H,6H,7H,and 8H) and the OFF setting.

INFRARED REMOTE CONTROL

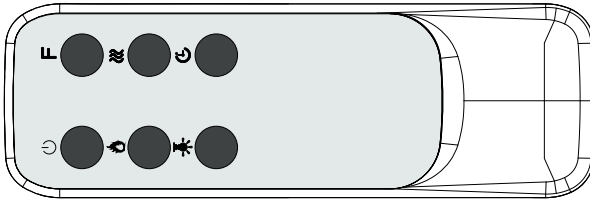

⚠ WARNING

Remote control requires two AAA batteries

⚠ WARNING







DO NOT mix old and new batteries.

DO NOT use rechargeable silver oxide cell batteries with remote control unit.

DO NOT mix alkaline. Standard (Carbon-zinc). Or rechargeable (Nickel - Cadmium) batteries.

DO NOT dispose of batteries in fire. Improper disposal may cause batteries to leak or explode.

INFRARED REMOTE CONTROL

BUTTON	FUNCTION
 <p>POWER</p>	<p>ON: Enables control panel functions and remote control. Turn on flame effect.</p> <p>OFF: Disables control panel functions and remote control. Turn off flame effect.</p>
 <p>FLAME</p>	<p>COLOR button: Makes the color flame effect changing. There are a total of 12 flame color effects. After cycling through all 12 flame colors and pressing once more, it will enter the flame color loop mode. Keep press 3 seconds Makes flame effect dimmer and brighter. Press again until desired setting is reached. Keep press 3 seconds Makes flame effect dimmer and brighter.</p>
 <p>HEATER</p>	<p>HEATER button: Turn heater on and off.</p> <p>NOTE: To prevent overheating, the heater fan will blow out cool air for 30 seconds after the heater turn off.</p> <ol style="list-style-type: none"> 1. Press once. Indicator lights up. 750W heater turns on and blows warm air. 2. Press again. Indicator lights up. 1500W heaters turns on and blows hot air. 3. Press again. Heaters turn off. <p>The fan blows cool air for 30 seconds to allow heater to cool down, then turns off.</p>
 <p>TEMP</p>	<p>1. TEMPERATURE button: Control temperature settings to choose temperature as desired. Setting range from 62F to 82F. Press once. Indicator light turn on. Temperature is set to 62F. 21 Settings: (62F, 63F, 64F, 65F, 66F, 67F, 68F, 69F, 70F, 71F, 72F, 73F, 74F, 75F, 76F, 77F, 78F, 79F, 80F, 81F, 82F)</p>
 <p>COLOR</p>	<p>1. The DIMMER controls the brightness of the flame effect. Press the button to set the flame effect to the desired level.</p> <p>NOTE: This button only on remote</p>
 <p>TIMER</p>	<p>TIMER button: Control timer settings to turn off fireplace at selected time. 8 Settings range 1H, 2H, 3H, 4H, 5H, 6H, 7H, 8Hours.</p>

IMPORTANT SAFETY INSTRUCTIONS

When using this electrical appliance, basic precautions should be followed to reduce the risk of fire, electric shock, and injury to person, including the following :

- 1.This heater must be used on an AC supply only and the voltage marked on the heater must correspond to the supply voltage.
- 2.Do not switch the appliance on until it properly installed and described in this manual.
- 3.Do not leave the appliance unattended during use.
- 4.Do not leave the appliance unattended whilst connected to the mains supply.
- 5.Keep out of reach of children and do not allow them to operate this appliance.
- 6.From time to time, check the cord for damage .Never use the appliance if the cord or any part of the appliance shows signs of damage.
- 7.Do not operate this appliance with a damaged plug or cord, after a malfunction or after being dropped or damaged in any way.
- 8.Repairs to electrical appliances should only be performed by a qualified electrician.
- 9.Improper repairs may place the user at serious risk.
- 10.Do not run the cable under carpets, rugs etc.
- 11.Do not allow the mains cable to hang over sharp edges or come into contact with hot surfaces.
- 12.WARNING: In order to avoid overheating, do not cover or obstruct the heater in any way.
- 13.Overheating will result if it is accidentally covered.
- 14.Never immerse the product in water or any other liquids.

LED BULB REPLACEMENT

Note: The flame effect on this electric fireplace insert is created by LED Bulbs.

The life of these LED bulbs will be 100,000 hours. The users are not recommended to Replace the LED Bulbs. For any reason should the bulbs stop working properly, contact a Qualified technician.

Cleaning

1. Turn heater OFF and unplug from electrical outlet before any cleaning or maintenance is performed. Wait at least 10 minutes to allow all components to cool properly.
2. Use a vacuum or duster to keep heater and vent area clean from dust and dirt.
3. The exterior of the fireplace should be cleaned with a damp cloth or duster.
4. Do not use abrasive cleaners or liquid sprays.

⚠ WARNING

1. To avoid electrical shock not open the back panel of the insert unless the power has been turned off. And the insert has been unplugged.
2. Any electrical repairs to this electric fireplace. Should only be performed by a qualified technician.
3. Any electrical wiring repairs should only be performed by a qualified technician. And also must comply with local buildings codes.
4. Discontinue use of this electric fireplace if any of the follow has occurred: Water damage. If insert has been or dented. If power cord has become broken. If power cord becomes hot to touch, if unit smokes or smells like smoke.

Note:

When the heat functions is used for the first time. A slight odor may be present. This is normal and should be occur again unless heater is not used.

For extended periods of time and dust is allowed to accumulate on heater element.

Technical Specification

- **Supply:** 120V/60Hz
- **Rated power:** 750W/1500W

Meaning of crossed - out wheeled dustbin:

Do not dispose of electrical appliances as unsorted municipal waste, use separate collection facilities.

Safety Cut-Off

- This appliance is fitted with a safety cut-off which will operate if the fire overheats (e.g. due to blocked air vents) .For safety reasons, the fire will NOT automatically reset.
- To reset the appliance, disconnect the appliance from the mains supply for at least 15 minutes. Reconnect the supply to the mains and switch on the appliance.

TROUBLESHOOTING

Symptom	Solution
No operation/no fan	Check fuse by replacement, Check for safety cut-off operation
No fire effect light	Check the LED light with technician.

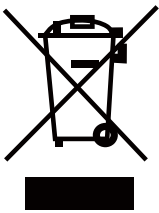

Meaning of crossed –out wheeled dustbin:

- Do not dispose of electrical appliances as unsorted municipal waste, use separate collection facilities.
- Contact you local government for information regarding the collection systems available.
- If electrical appliances are disposed of in landfills or dumps, hazardous substances can leak into the groundwater and get into the food chain, damaging your health and well-being.

When replacing old appliances with new ones, the retailer is legally obligated to take back your old appliance for disposals at least free of charge.

HELP CENTER

Question about your product? We're here to help. Visit us at:

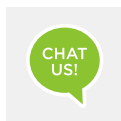

Chat Support



Product Inquiry

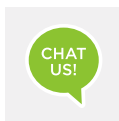

Orders FAQ



Product Assembly



Returns & Refunds

We Stand Behind the Quality of Their Furniture

If you have any issues with your item please let us know! We will always do our best to come up with a solution that you will be happy with.

Please get in touch with our customer service team before returning the product.

And pls do not throw the original box(es) if you have not finished assembling or confirmed no quality issues.

Length of return period:

Items can be returned within 30 days of purchase.

In the meanwhile, everything you purchased from us comes with a one-year warranty.

Who is responsible for the return shipping fee:

We will cover the return shipping fees if:

1. Your item has a manufacturing defect in its materials or workmanship. For example, torn wicker or misaligned screw holes. We will send you a prepaid shipping label after photos are sent.
2. Your item has been damaged in transit. For example, glass is broken or wicker is damaged. We will send you a prepaid shipping label after photos are sent.
3. You receive the wrong box(es) due to a warehouse error. We will send you a prepaid shipping label after photos are sent of the wrong SKU numbers on the outer box(es).
4. One or more boxes are lost in transit. We will send you a prepaid shipping label if you no longer want the item.

* However, we still hope to work with you for a better solution instead of a return. Please don't hesitate to contact our customer service team.

Customer will cover the return shipping fees if:

1. You don't like the product(s) after receiving the box(es).
2. You no longer need the product(s) but you have received the box(es).
3. You buy the product(s) by mistake but you have received the box(es).
4. Order/Shipment cancellation failed and you have received the box(es).

Return Request

In order to get a full refund as described in this return policy, all items must be: (1) In a brand new/unused condition, please provide photos before and after packaging. (2) When returning, all accessories and parts are firmly packed in all original packaging.

If your return does not meet the requirements, you may not get a full refund.

When will I be refunded?

The refund is released once the goods have been returned to our warehouse.

What if the product is damaged/defective outside of the valid return period?

We want you to be a happy customer. Please reach out to us by email and we will come up with a solution to make sure you are satisfied.

APP Connecting Instruction

1. App download

- Download "Tuya Smart" from the app store.
- Scan the QR code.
- Turn on the "GPS" from your mobile device.



Note: make sure your mobile phone is well connected to the nearest WIFI signal.
Note: because of the app update, the interface and icons may be partially different

2 Login

- Register with your email ID or Mobile phone number as the user name.
- Setup your account password.

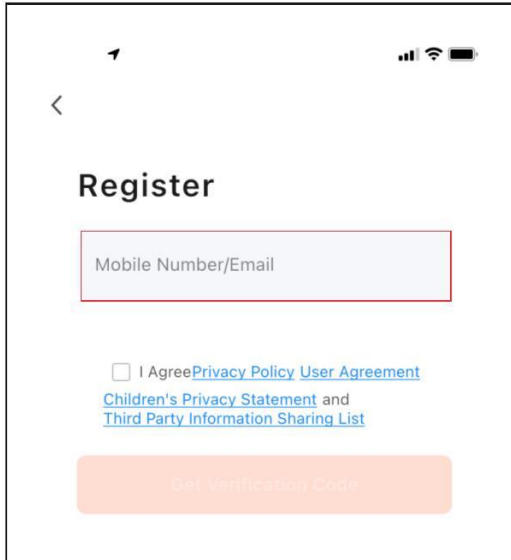

3. Add device

After account is created, log into account and select the "Add Device" button.

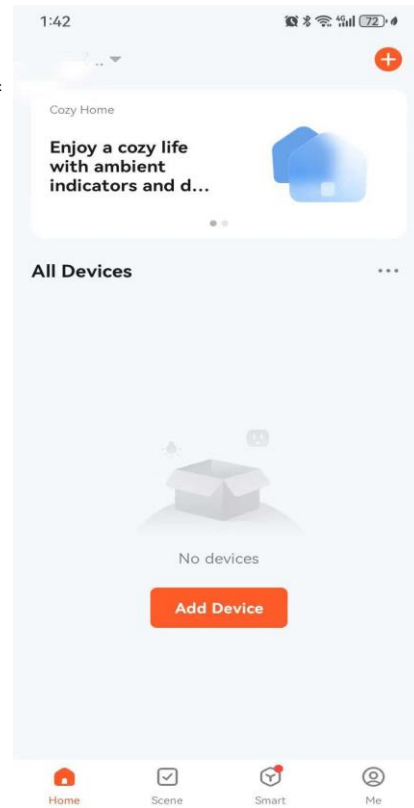

.Add device - Continued

- First way: Select the Add Manually button (Follow below step A,B,C,D)
- Second way: Select the "Add" button. (Open Bluetooth on your mobile phone before adding)

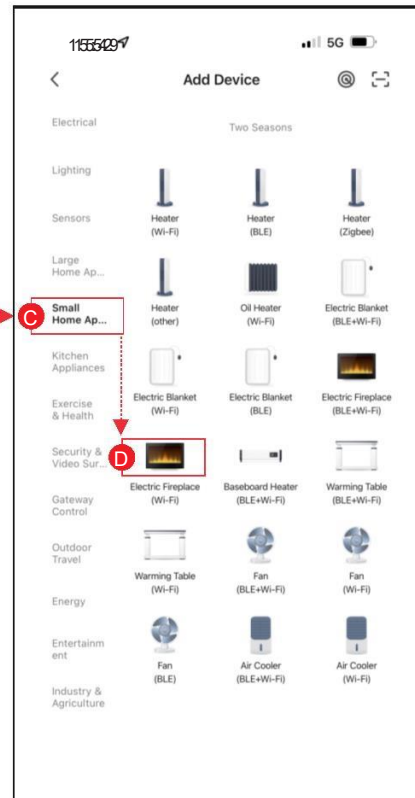
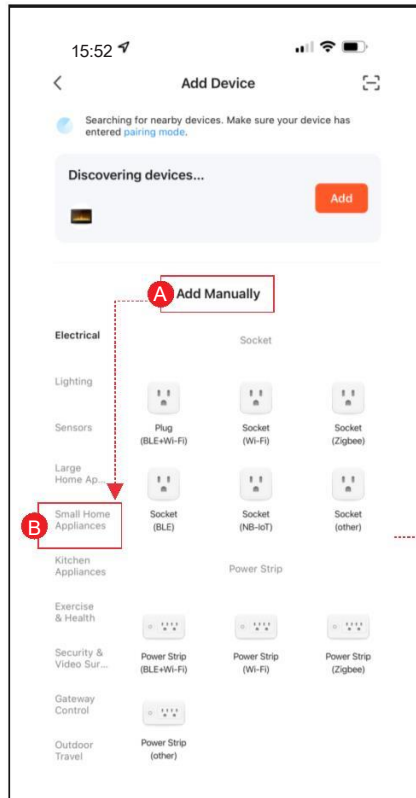

4. Connecting method - (P0)

- Press & hold  from remote control or control panel for 5 seconds, display on control panel shows "P0".
- Enter the WIFI name and password, then press "Next" button for pairing.
- Press the Blink Quickly button for "P0", device being added.

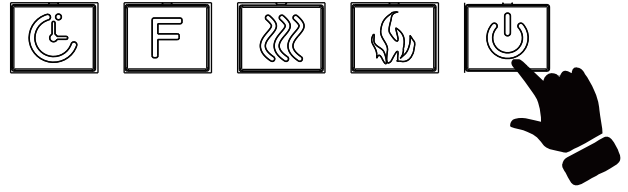

Note : please check the router setting if connect failed, make sure select **2.4 G** Network, because some routers have dual band 2.4 G and 5 G in one

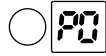
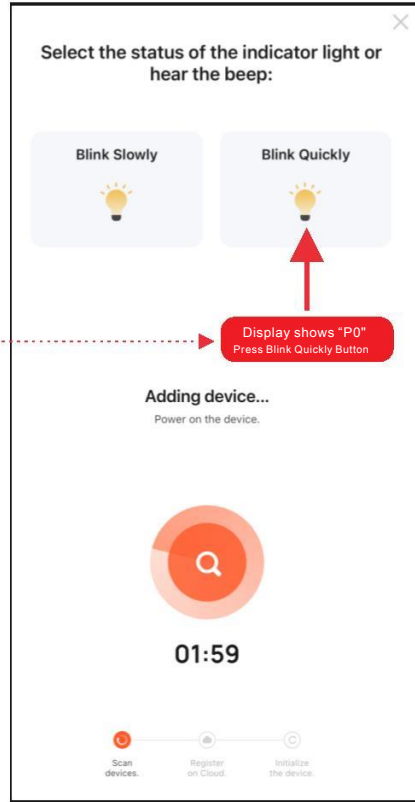
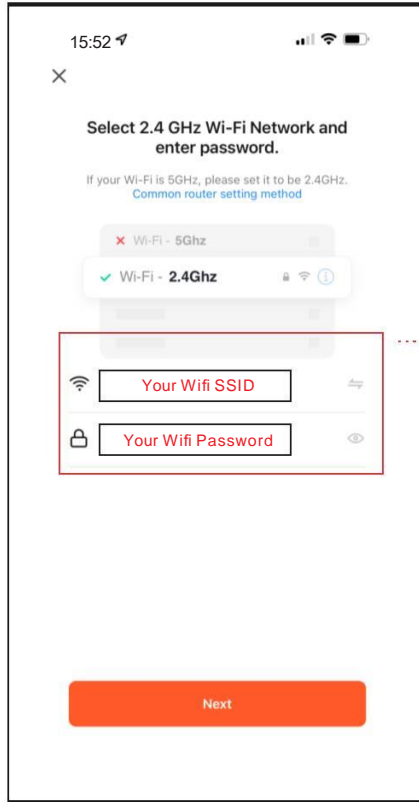

5. Complete

- Press Done to complete.

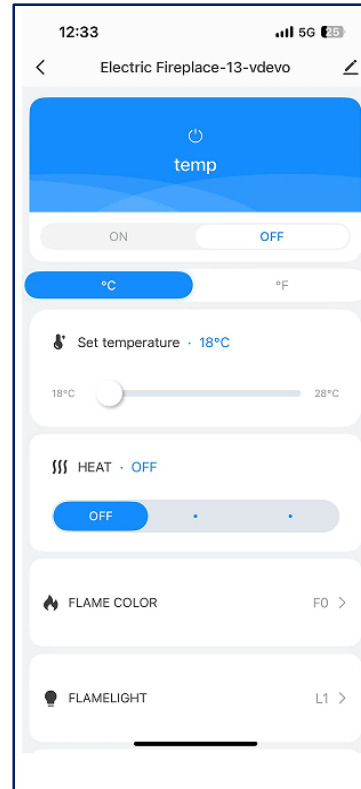
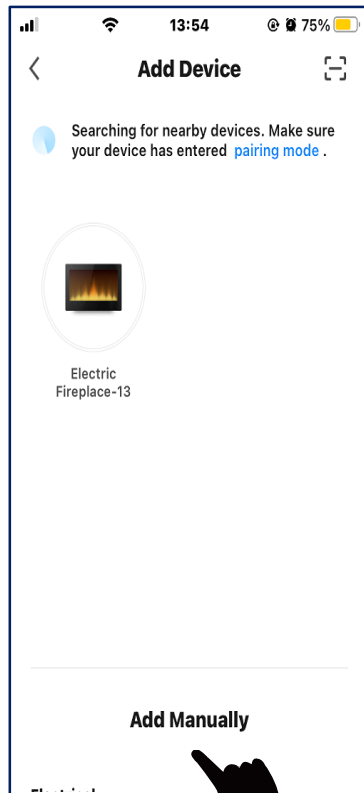

LED2022 -24KEY

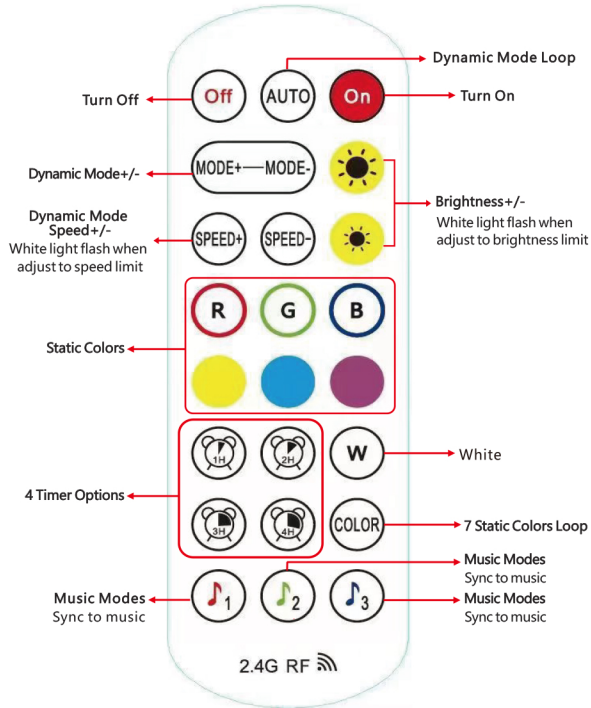

Notices

1. Please pull out the battery insulated plastic chip before using remote.
2. Press the lock key, the remote keys will be locked, press the lock key again, all the remote keys will be unlocked.

1

LotusLantern APP Manual

1. Software Overview

1.1 Overview

LotusLantern is a mobile APP to control LED strip by both Apple and Android phones. The traditional control ways like infrared, 433MHz, 2.4GHz and others old wired ways will be replaced by mobile phone control way with convenient, powerful and scalable features.

Through this mobile APP, you can not only control the color, brightness and color temperature of the LED strips but also set up all kinds of fancy flash mode; Also this APP can change the light of the LED strip according to the rhythm of the music. This APP can set and control several LED strips through Bluetooth and the operation is very simple, easy to learn and easy to use.

1.2 Features

- Adjust color LED strips with 60,000 colors to change color and brightness and adjust monochrome LED strips to change brightness and color temperature
- Play music or turn on a sound playback device, you can let the light change the color and brightness with the rhythm of music, the music rhythm beautiful
- Inside multiple setting mode for color change and control LED strips without mobile
- Long distance control with omni-directional antenna, and many-to-many group control mode
- Once the connection is successful, connect automatically next time

1.3 Performance

LotusLantern APP is easy to use as well as great compatible for all kinds of smart phones; After the actual test of hundreds of mobile phones verification, the compatibility is above 95% of mobile phones in the market. APP is small and convenient, it consumes less system resources, so the requirements of the mobile configuration are low. Control delay is small, the operation feel good, light control is smooth with people's visual sense.

2. Operating Environment

This APP program requires phones of system above Android 4.3 and iOS 8.0. Mobile phone configuration is not limited.

3. Instructions

Note: Android version and iOS version download and use the same method, here in the Android version as an example.

3.1 APP Download

Scan the QR code

iOS and Android systems can download the "LotusLantern" APP by scanning the QR code. Open the browser or other tools with "Scan QR code" function, scan the "LotusLantern" QR code as below:



2

3.2 App Operation

(1) Click on the LotusLantern APP icon, enter the APP page:



(2) After entering the APP interface, if Bluetooth is not enabled, "Lotus Lantern wants to turn on Bluetooth." Click [Allow]

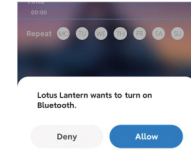

(3) Switch to color and brightness interface:

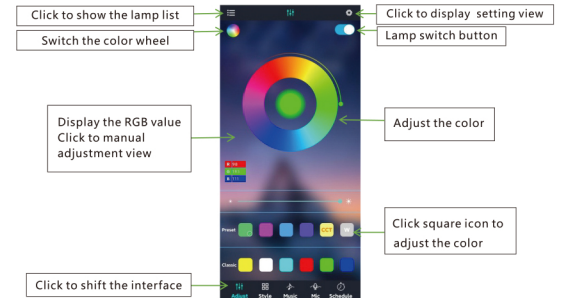

3

(4) Click to show the lamp list, view lamp list:

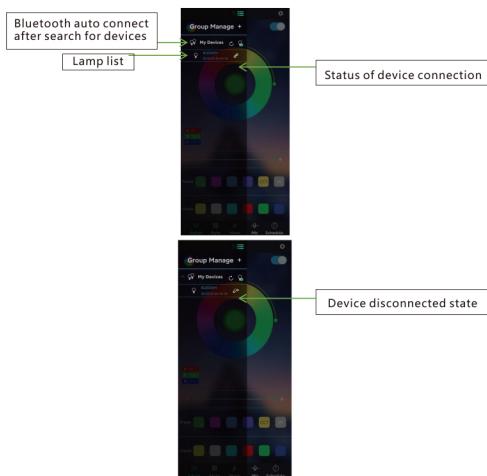

(5) Click to RGB manual adjustment view: (6) switch to the mode interface:

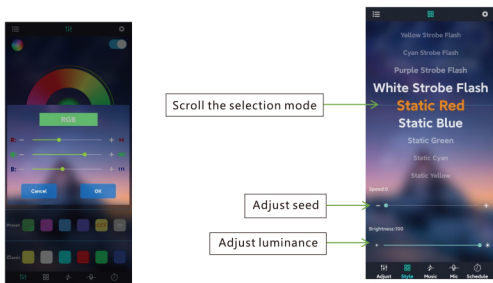

4

(7) switch to the music rhythm interface:

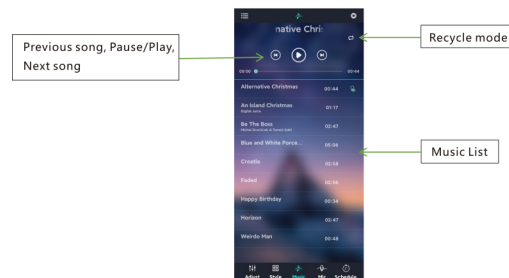

(8) Switch to the microphone rhythm interface:

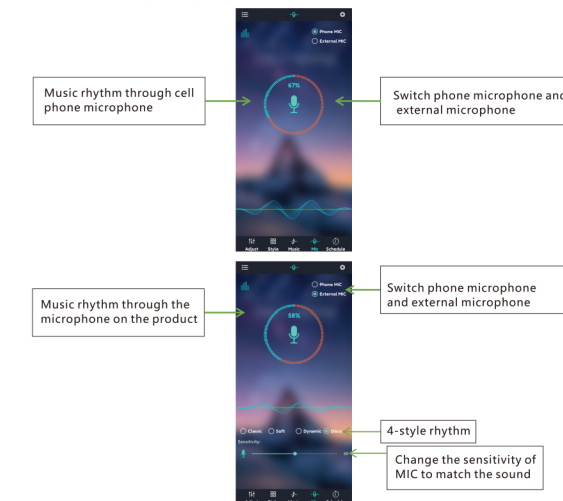

5

(9) Switch to the schedule interface:

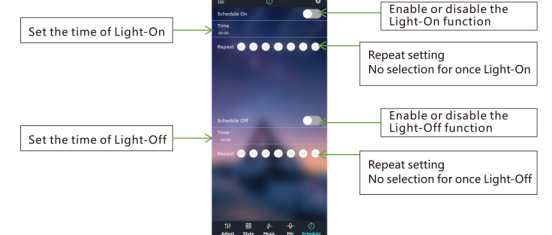

(10) Switch to the modify pin sequence interface:

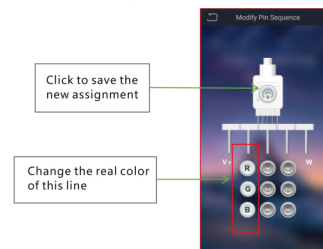

6