























Assembly Instructions

A  x1	B  x1	C  x1	D  x1	E  x1	F  x1	G  x2	H  x2	I  x2	J  x2	K  x4
L  x1	M  M8*60mm x2	N  M8*40mm x16	O  M8*20mm x4	P  x18	Q  x2	R  x2	S  x1	T  x2	U  x4	V  x1



1. Screw the sofa legs (Part K) into sofa arm (Part A & B), Then put a felt pad(Park U) on the bottom of the sofa legs.

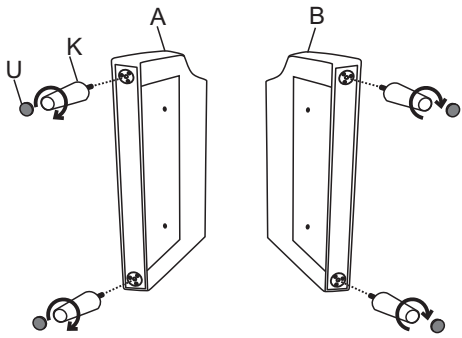
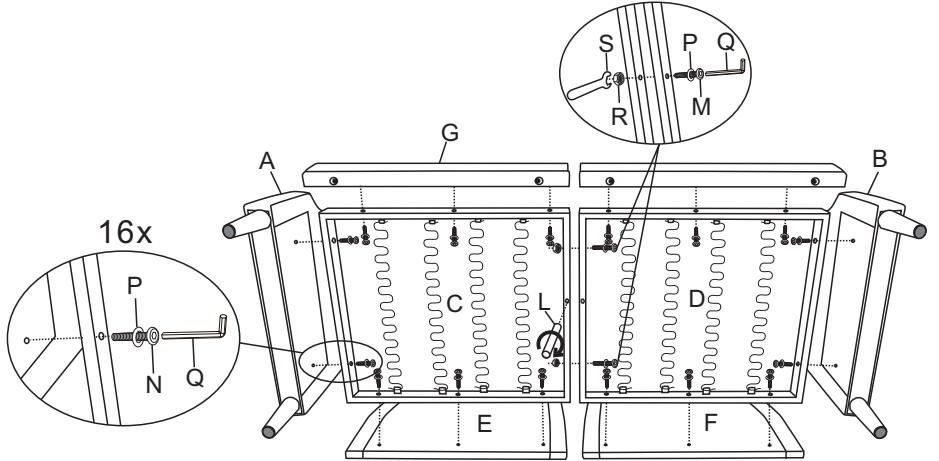

2. Connect Part A&B (sofa arms), Part E&F (Back Frame) Part G (Wood Piece), then install the screws(Part N) & gaskets (Part P) with Toll (Part Q).Connect Part C&D (seat Frame), then install the screws(Part M) , gaskets (Part P) & screws (Part R) with Toll (Part Q) and spanner(Part s).Finally screw the middle leg.

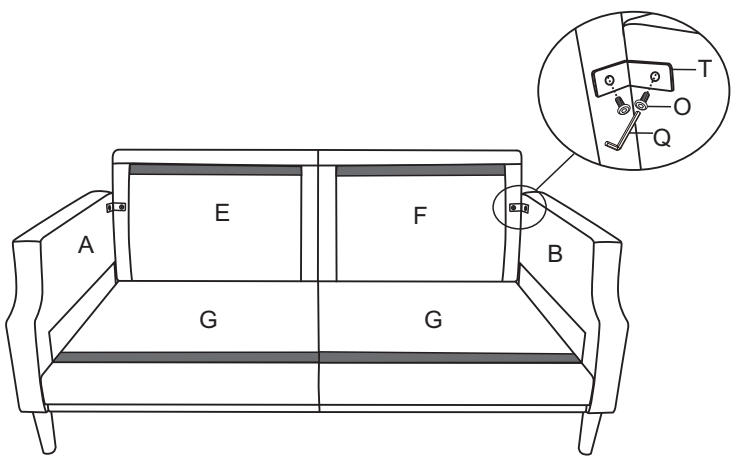

3.Connect the back frame (Part E&F) by aligning the metal piece (Part T) on Arms (Part A&B), then install Screw (Part O) with Toll (Part Q)

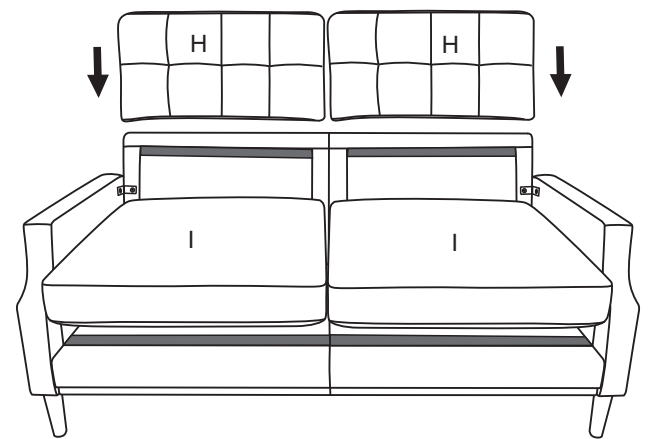

4. Take out the seat cushions (Part I) & back cushions (Part H) and put them on the sofa and tidy them ok , the suchions will be connect with hook and loop fasteners.

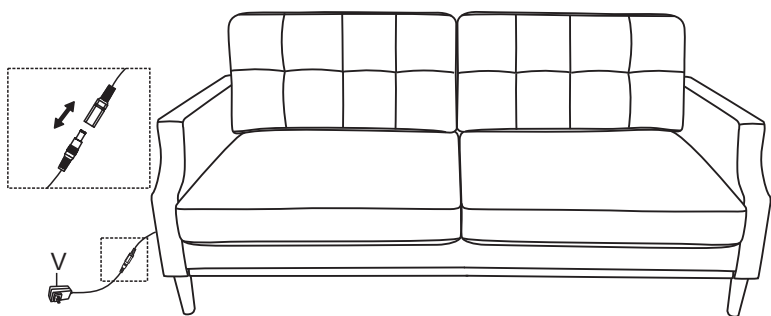

5. Connect the plug with the power line under of the sofa, then you can charge your phone when you sit on the sofa.

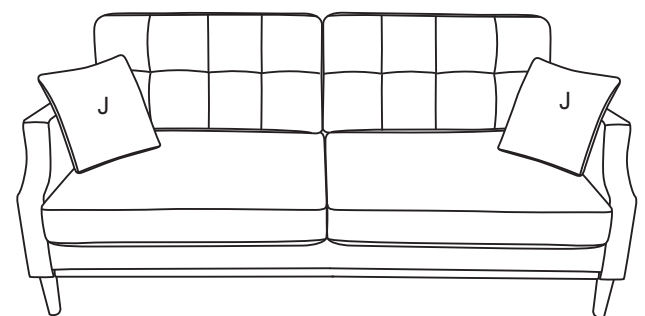

6. Two pieces of Pillows (Part J) included.