

## ABOUT *Artist hand*<sup>®</sup>

---

We believe every barber has a pair of artist's hand that brings us beauty and confidence. The brand **Artist hand** will provide you with one-stop service and experience, and assist you to create a better life by opening a barber shop quickly!

**Artist hand** is a rapidly growing e-commerce platform which provides high quality specialists products for the salon, beauty, barber and spa industries. We are committed to providing perfect quality, reasonable price and excellent service for every barber shop, and becoming a favorite amongst professionals. There is a wide selection of styles from vintage barber chairs to more modern, functional designs. Meanwhile, the custom package can include the reclining barber chair, all purpose salon chair, shampoo chair and other modern salon equipment, used to provide a range of high quality styling units to complement your barber shop.

---

 ▪ **Amazon** : <https://www.amazon.com/artisthand>

---

 ▪ **Website** : [www.artisthandbeauty.com](http://www.artisthandbeauty.com)

 ▪ **Customer service Mailbox** : [info@artisthandbeauty.com](mailto:info@artisthandbeauty.com)

 ▪ **Facebook Page** : Artisthand

 ▪ **YouTube** : [youtube.com/c/Artisthand](https://youtube.com/c/Artisthand)

 ▪ **Installation video in youtube.com/c/Artisthand** :  
Search No.: U3070101400



Amazon Shop



Artisthand Website

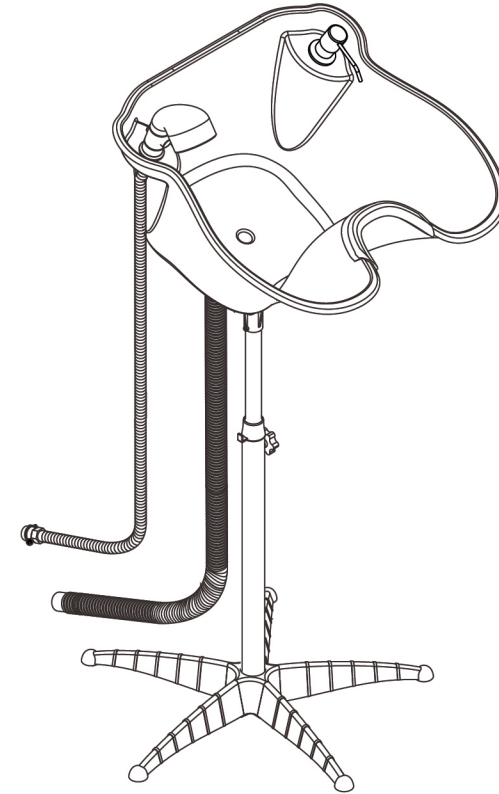

# Shampoo Bashin

---

## Instruction Manual

COLOR: Black U3070101400

## 1.4 Trouble and Solution

No.	Trouble	Solution
1	Basin tilts forward	Please see the step 4 of 1.2 Installation Diagram on page 4 of the instruction manual. please make sure the directions of A and B are installed as shown.
2	Water inlet pipe leaking	Please see 1.3 Operation Guide on page 6 of the instruction manual. it has two connection methods for different size of taps, please tighten the locking device before use.
3	Water outlet pipe leaking	Please see the step 5&6 of 1.2 Installation Diagram on page 4 of the instruction manual. please tighten the locking device before use.
4	How to use the shower	Please see 1.3 Operation Guide on page 7 of the instruction manual. it has spray and stop functions, please follow the diagram to control the shower(push the button for spraying, pull the button for stop)
5	Shampoo dispenser loose	Please see step 11&12 of 1.2 Installation Diagram on page 6 of the instruction manual. please make sure the rubber ring is placed in the exact position before fasten.
6	Other issues	If you have any other problems, please Email to <a href="mailto:info@artisthandbeauty.com">info@artisthandbeauty.com</a> Our professional team will provided the technical support by pictures or videos.

## 1.5 Maintenance

No.	Maintenance Parts	Maintenance Method
1	Basin cleaning	1.Avoid using hard objects to scratch the basin. 2.The basin material is plastic, plastics are most afraid of high temperature, followed by compatible solvents, strong acids and bases, extremely low temperatures, physical impact, etc. please do not use corrosive solvents to clean.

## 1.6 Customer Service

Any question or suggestion please feel free to contact our Customer Service Team  
E-mail:[info@artisthandbeauty.com](mailto:info@artisthandbeauty.com)

### 1 Tools required

A Phillip head screwdriver or Power tools is required for the assembly of this product.(not included)

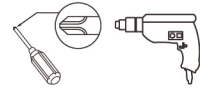

### 2 1 person is needed









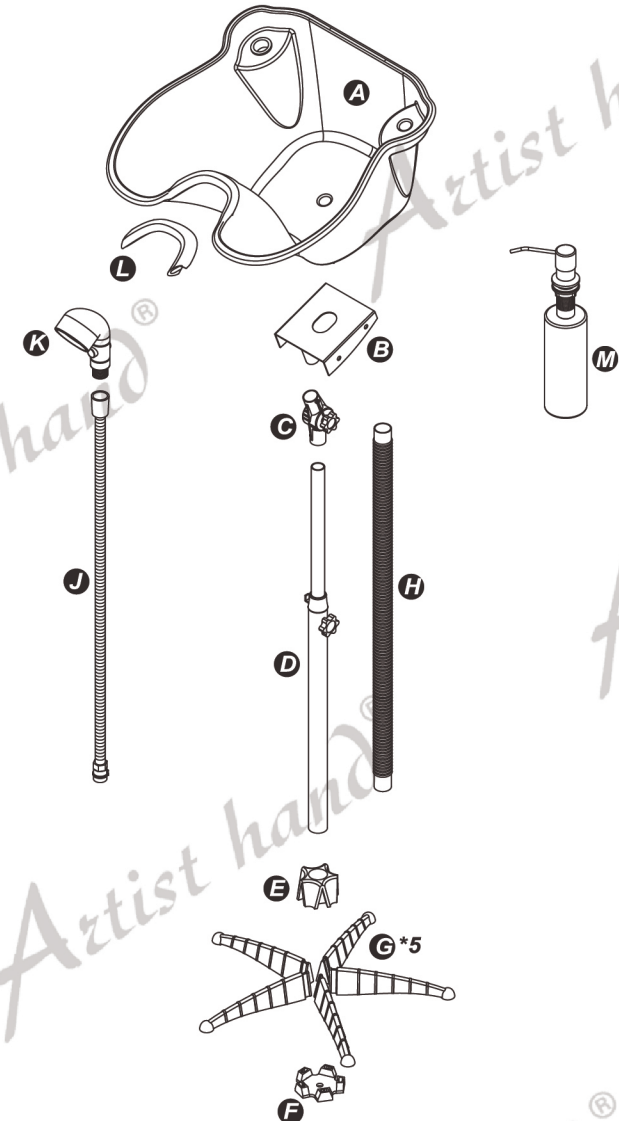





### 3 Take 15 minutes



## 1.1 Feature and Specification



## Main Parts

Parts Code	Image	Parts Name	Qty(Pcs)
A		Basin	1
B		Basin Bottom Bracket	1
C		Angle adjuster	1
D		Lifting Rod	1
E		Feet upperside connection	1
F		Feet bottom connection	1
G		Feet	5
H		Drain Pipe	1
J		Shower Pipe	1
K		Shower	1
L		Neckrest	1
M		Shampoo Dispenser	1

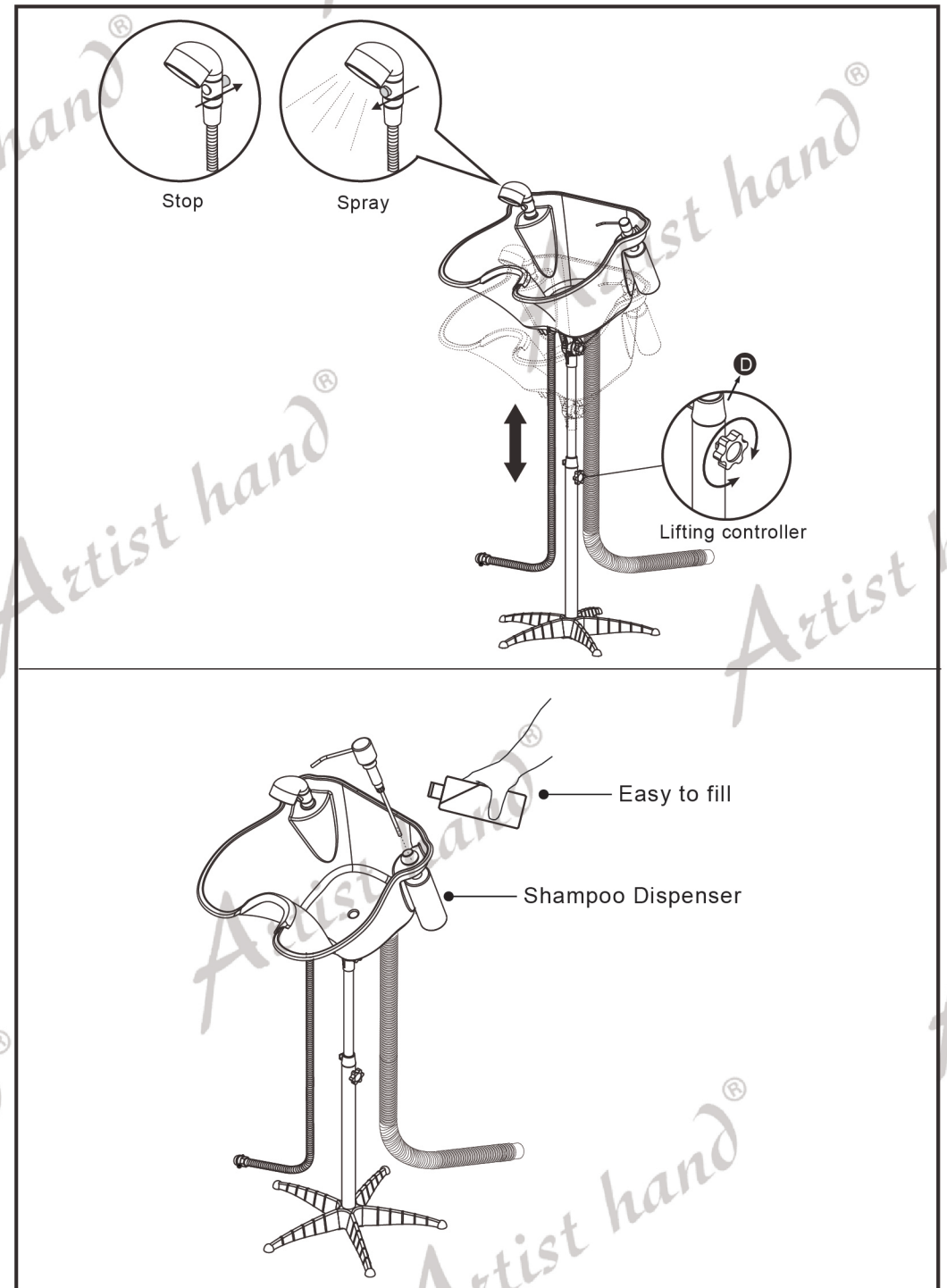

Step 11

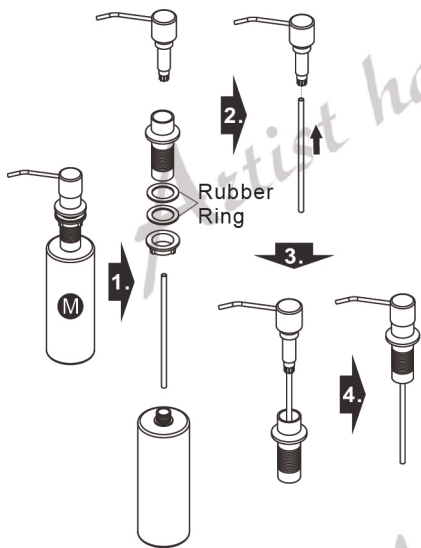
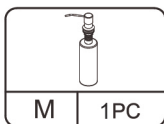

Step 12

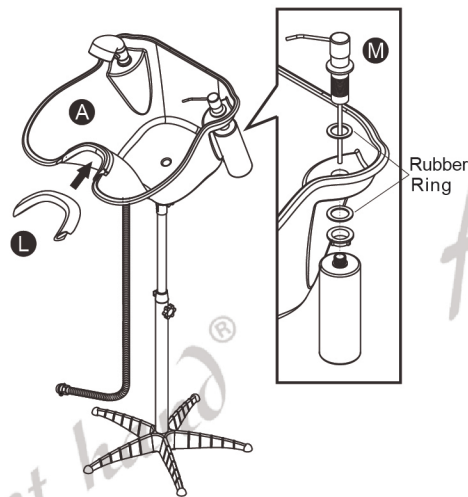
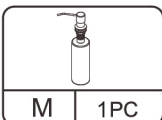
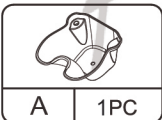

1.3 Operation Guide

Step1

Two connection methods for different size of taps

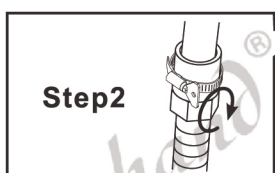
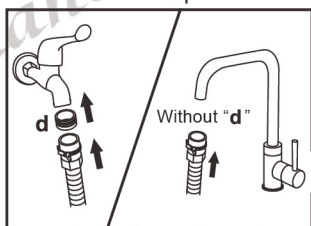

Please tighten the Locking Device before use.

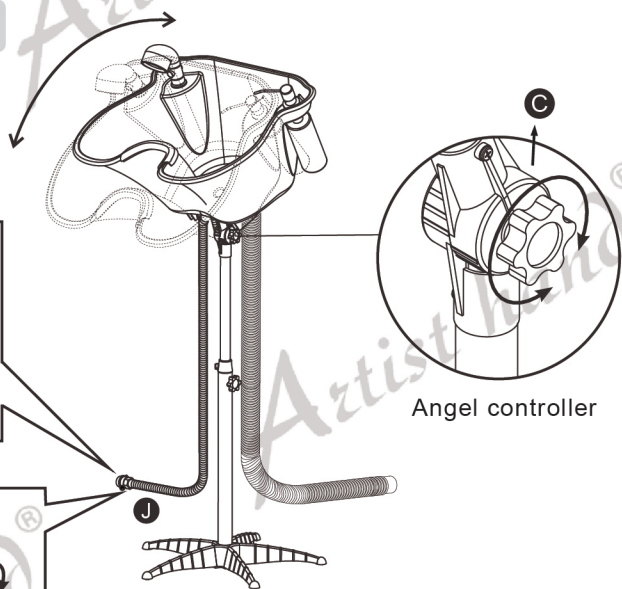

Preinstalled Accessories

Parts Code	Where to find	Parts Name	Qty(Pcs)
a	Preinstallaed on D	M8 Washer	1
b		M8*35 Bolt	1
d	Preinstallaed on J	Rubber Connector	1

Accessory Kit(Packed In a Small Bag)

Parts Code	Image	Parts Name	Qty(Pcs)
①		M8*30 Bolt round head	4
②		M8 Nut	4
③		Drain Pipe Locking Device	1

1.2 Installation Diagram

Step 1

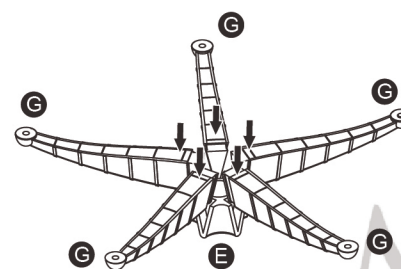
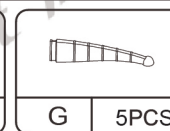
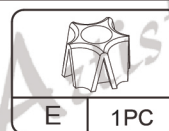

Step 2

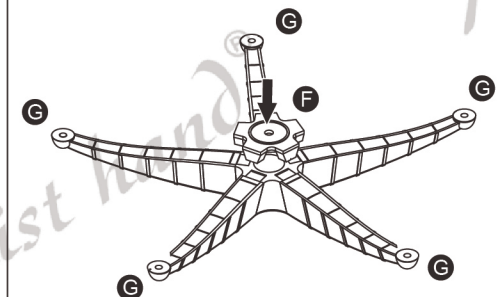
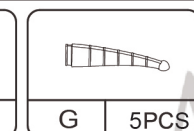
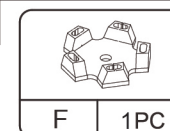

**Step 3**

D	1PC
F	1PC

a\*1, b\*1 were preinstalled on D

**Step 4**

A	1PC
B	1PC
①	4PCS
②	4PCS

**Step 7**

C	1PC
B	1PC

**Step 8**

D	1PC
C	1PC

**Step 5**

B	1PC
H	1PC
③	1PC

Locking Device

**Step 6**

③	1PC
---	-----

Please tighten the locking device before use

**Step 9**

C	1PC
---	-----

**Step 10**

K	1PC
J	1PC