

# 9161 Tischgestell Officia Bureau

## EAN: 4025621091615

**KARE**  
DESIGN

Email: [info@kare.de](mailto:info@kare.de)

**KARE Design GmbH** Zeppelinstraße 16, 85748 Garching-Hochbrück Germany

Geschäftsführende Gesellschafter: Jürgen Reiter, Peter Schönhofen

KARE Design GmbH HRB 164 249 Amtsgericht München Sitz: München Steuernummer: Finanzamt München für Körperschaften,  
143/153/40064 USt-ID: DE 250 622 249



[www.kare.de](http://www.kare.de) [www.kare-design.de](http://www.kare-design.de)

**39161 PENDANT LAMP**  
**SATURN LED CHROME SMALL**

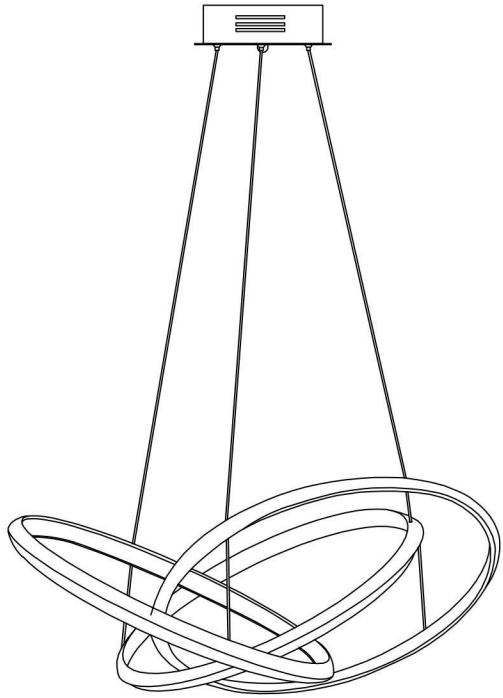
**KARE**  
 DESIGN



**Parts List**

NO	A	B
		
Qty	1	1

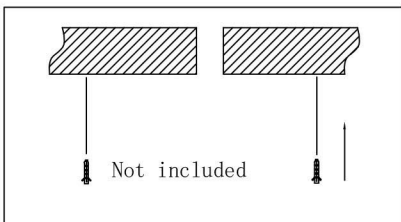

1

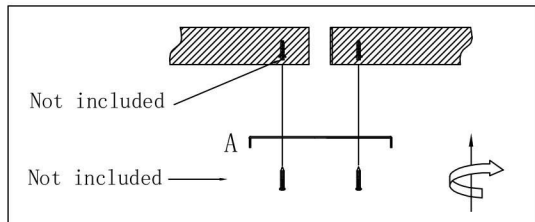

2

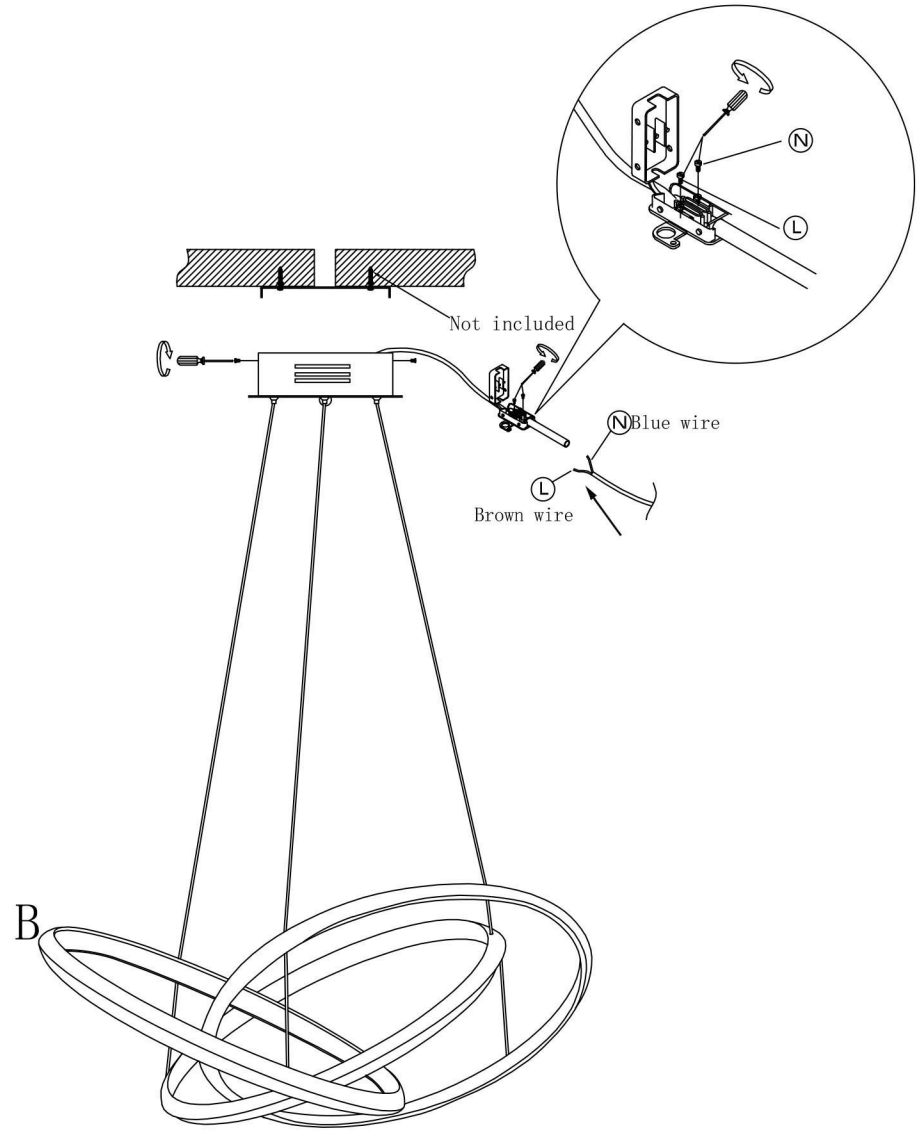

3

**TAVOLO DUO**



### **ITA**

Presenti 8 viti regolabili  
da avvitare alle estremità  
della gamba Tavolo Duo

### **EN**

Present 8 adjustable  
screws to be screwd to  
the ends of the leg Tavolo  
Duo

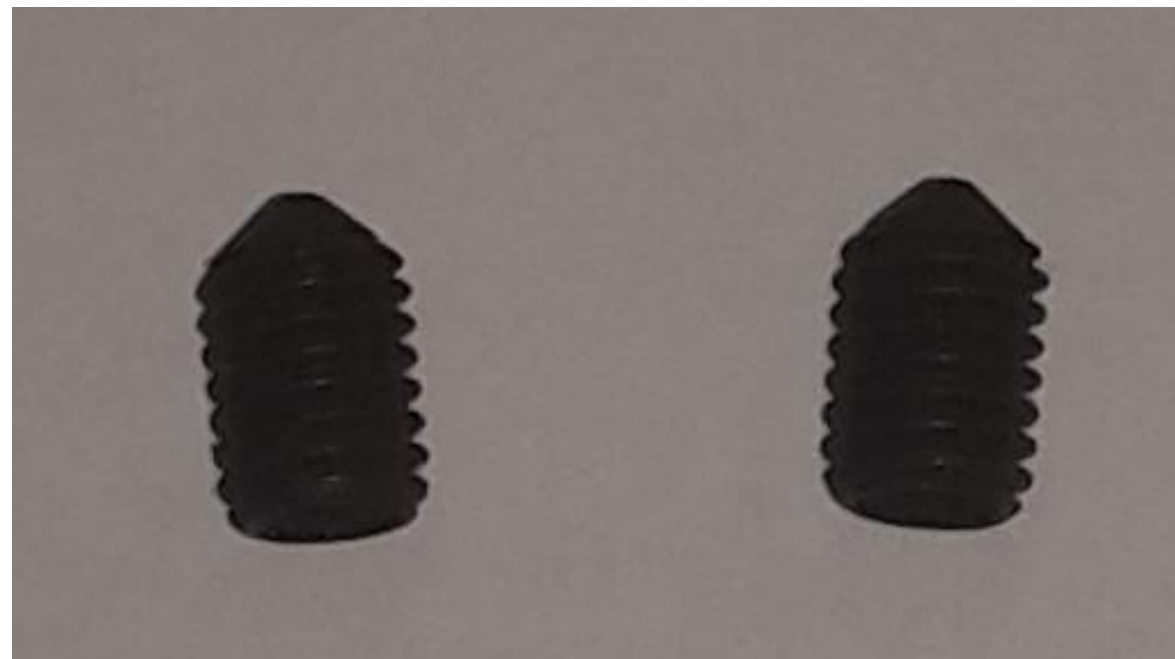
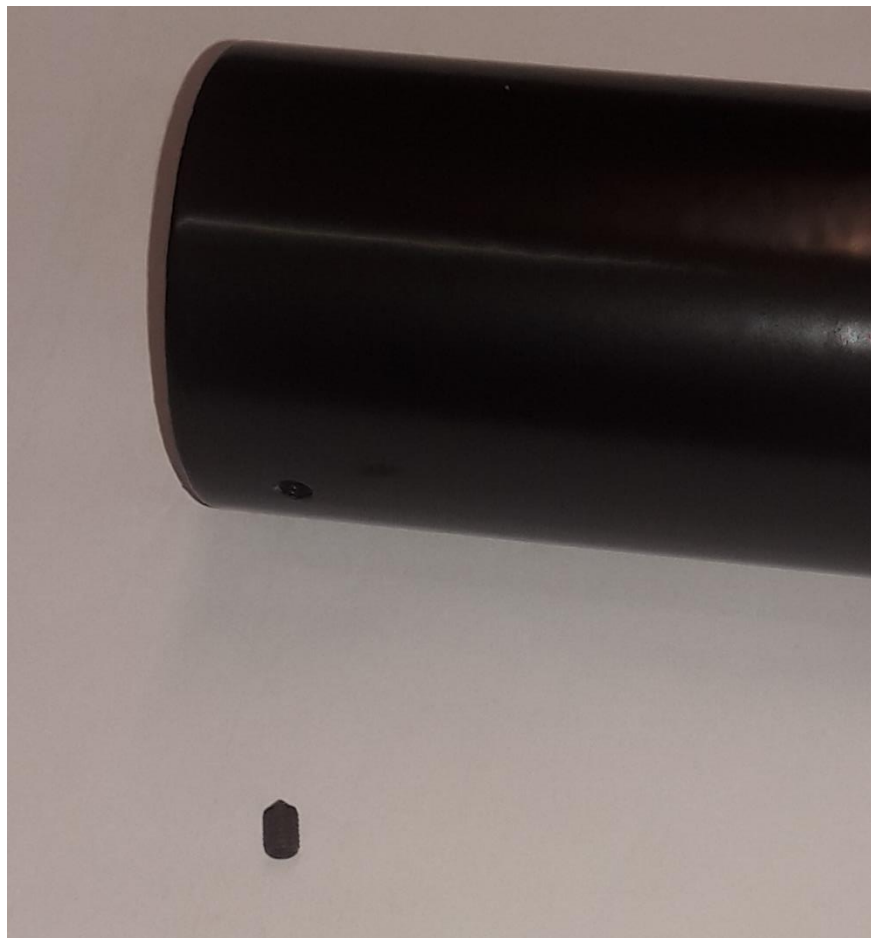

**ITA**

Viti esagonali da avvitare al tubo lungo 90  
cm

**EN**

Hexagonal screws to be screwed to the long  
tube 90 cm



**ITA**

N° 2 gambe Tavolo  
Duo da assemblare  
con tubo da 90 cm

**EN**

Number 2 legs to be  
assembled with the  
90 cm tube

