

Assembly Instruction

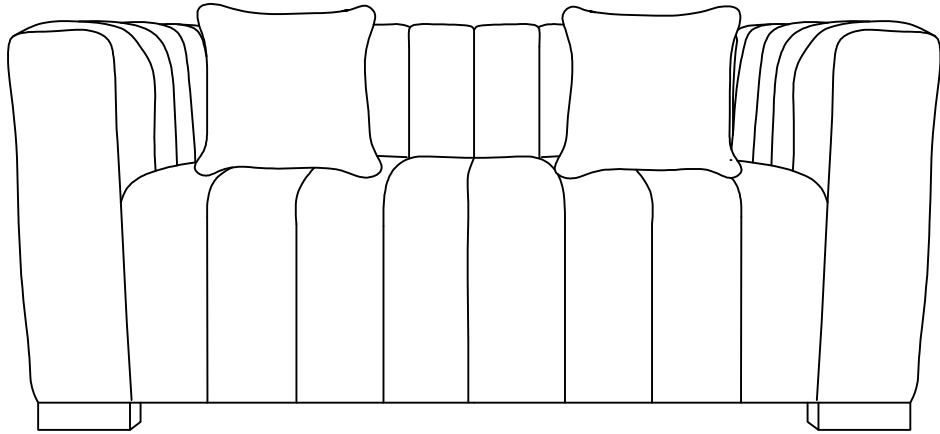

Loveseat

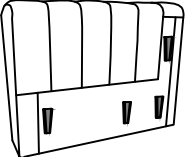
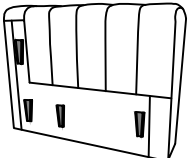
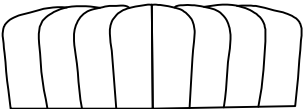
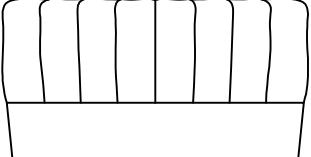
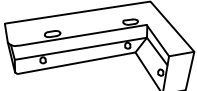
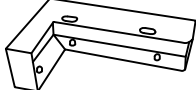
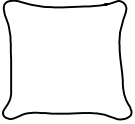

Parts List

Label	Picture	Description	QTY
AL	 A line drawing of a left armrest with a curved top and three vertical supports at the base.	Left Armrest	1
AR	 A line drawing of a right armrest, similar to the left one but mirrored.	Right Armrest	1
B	 A line drawing of a seat cushion with a curved top and vertical ribbing.	Seat	1
C	 A line drawing of a backrest cushion with a curved top and vertical ribbing.	Backrest	1
DL	 A line drawing of a left leg, showing a rectangular base with a vertical support and a horizontal top rail.	Left Leg	2
DR	 A line drawing of a right leg, similar to the left one but mirrored.	Right Leg	2
E	 A line drawing of a square pillow with a slightly rounded top and bottom.	Pillow	2

Hardware

Label	Picture	Description	QTY
①		Bolt (M8*30MM)	8
②		Washer	8
③		Allen Key	1

Assembly Preparation

Before Beginning Assembly:

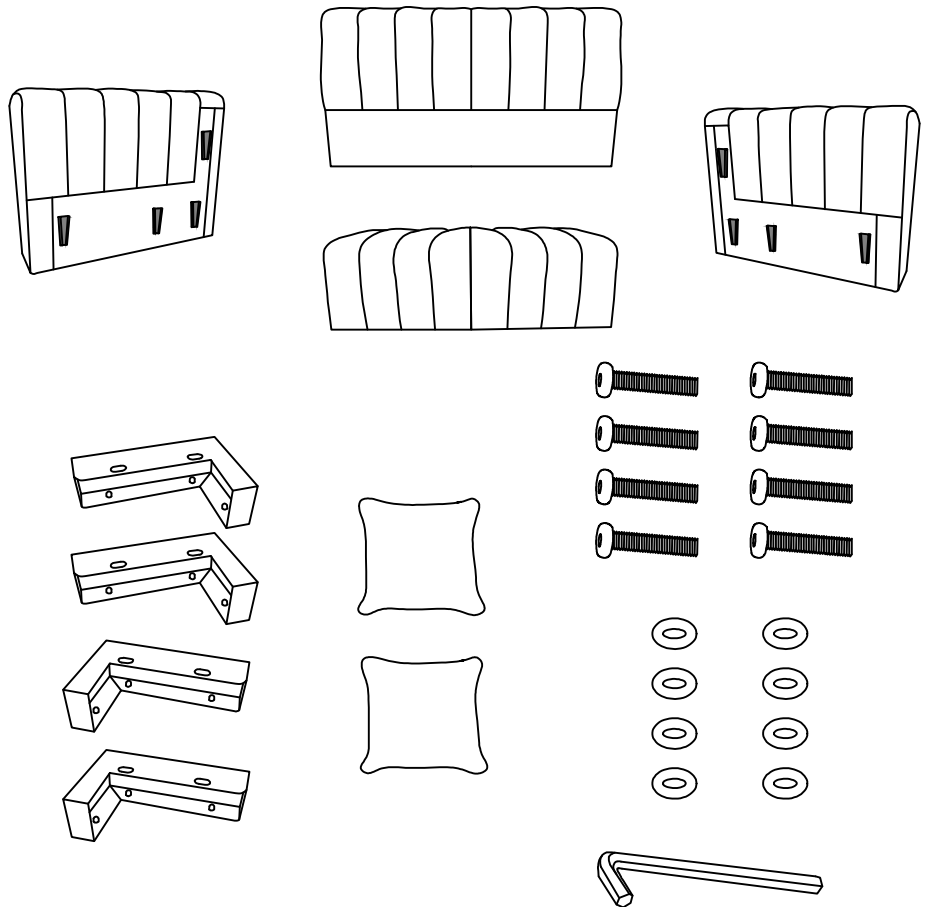

● Read instructions, cover to cover.



● Have 2 adults on hand for assembly.



● Do not assemble on flooring or carpet.



● Assemble on a clean non-marring surface (packing foam).



● Save all packaging until finished.

Step1

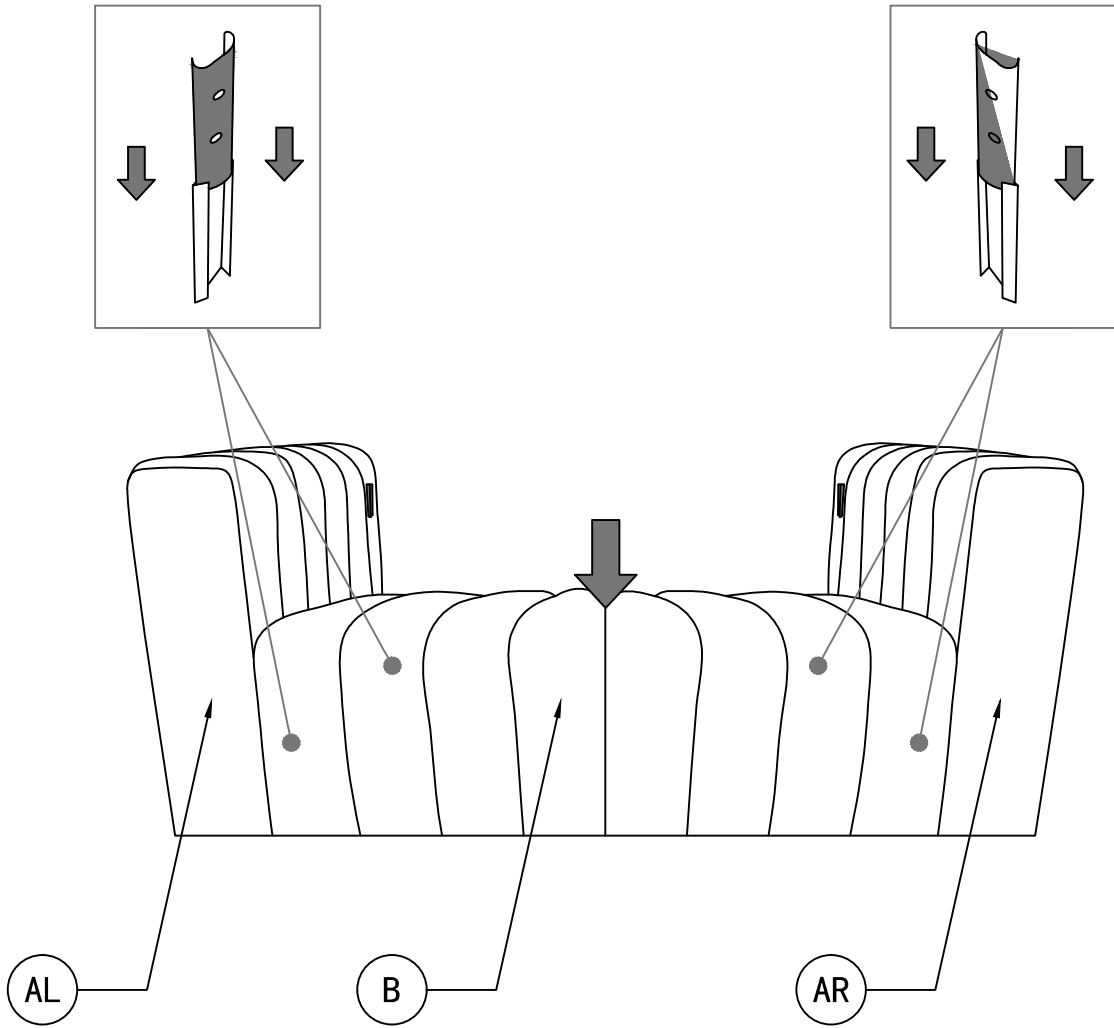

Step2

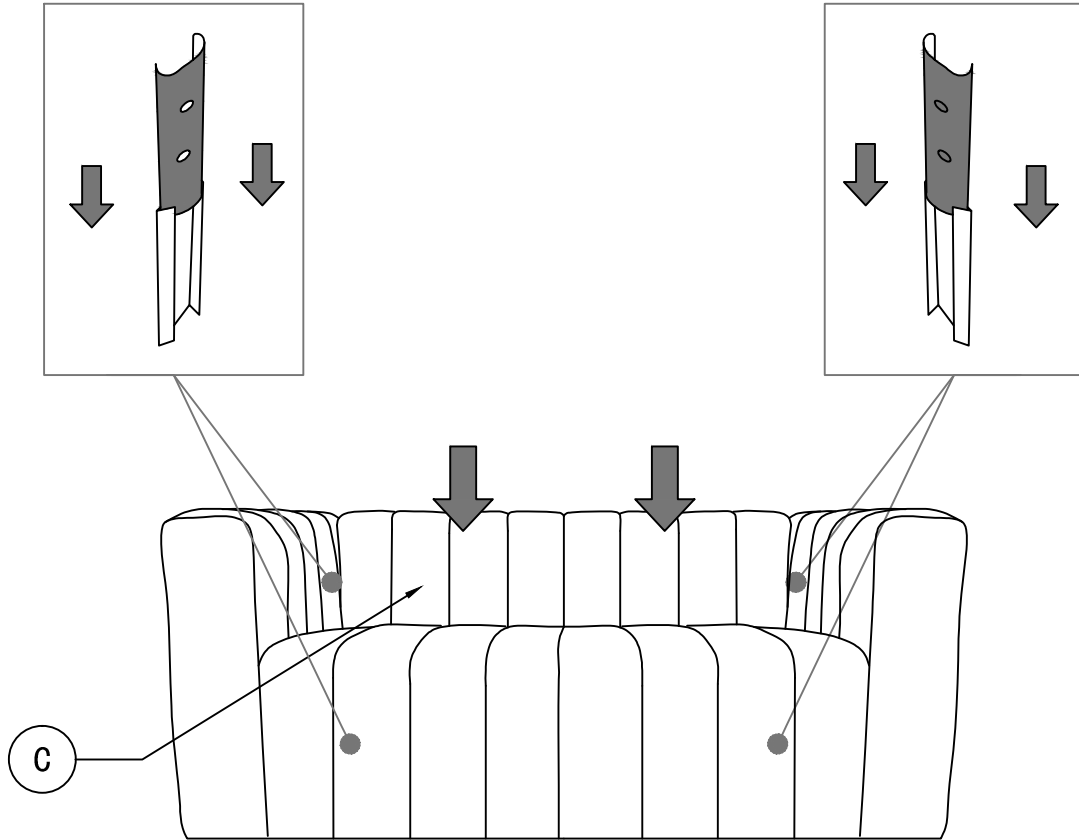



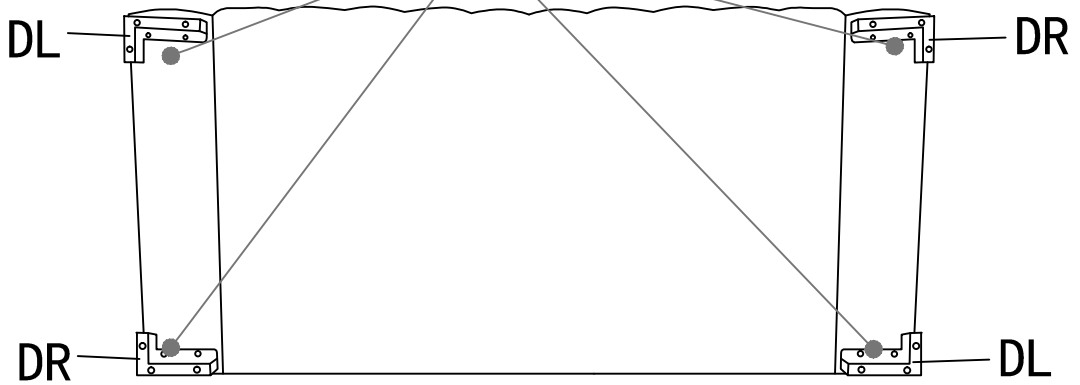
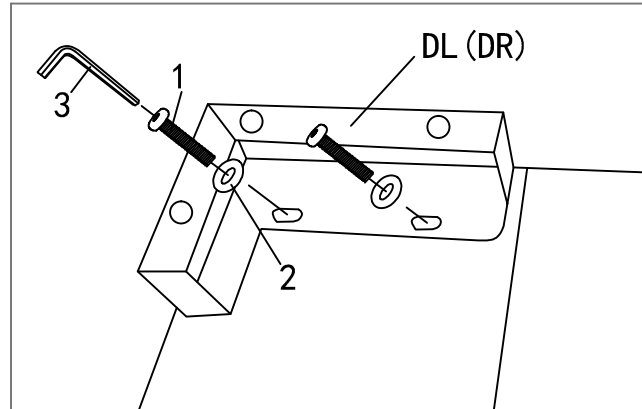
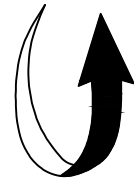
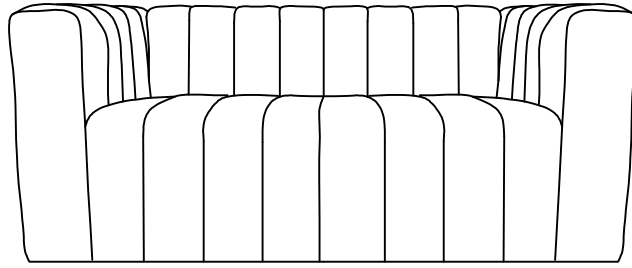



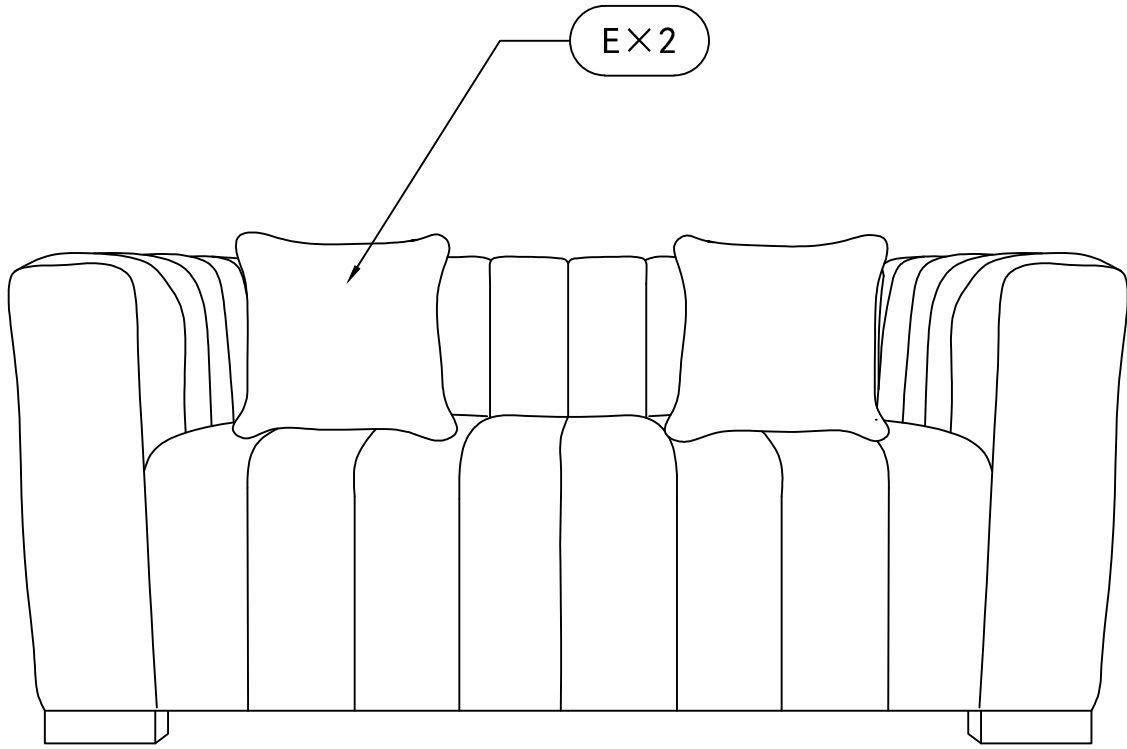



Step3



Step3



Care & Maintenance

-  Do not put hot items directly on furniture surface
 -  Do not clean furniture with harsh cleansers or polish.
 -  Do not place furniture under direct sunlight.
 -  Do not place furniture near heating or cooling vents.
 -  Do not write on furniture without a padded barrier to protect the surface.
 -  Do not place furniture outside . For indoor use only .
 -  Not for commercial use. For residential use only .
 -  Stains may be removed with mild soap solution and damp cloth.
 -  Children should not climb or jump on the furniture.
-
-  Dust and pick-up spills using a clean, non-colored, lint-free cloth .