

# INSTRUCTION

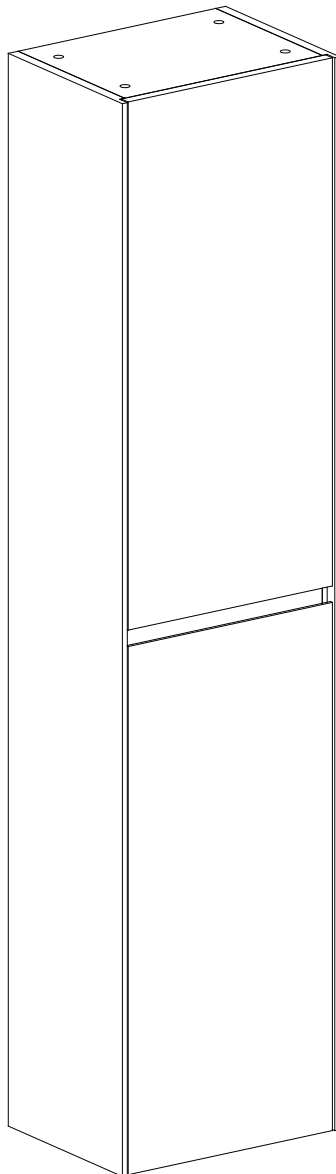

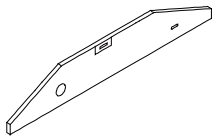

Spirit level

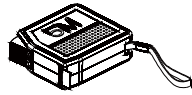

Tape measure  
(3m~5m)

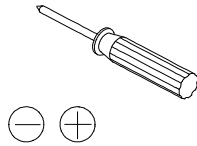

Screwdriver

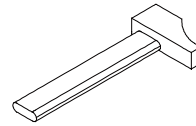

Hammer

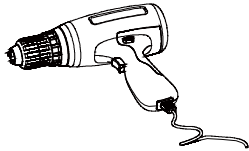
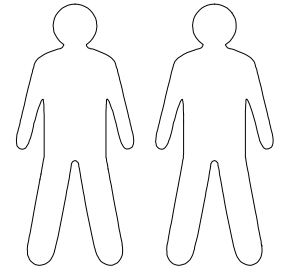

Electric drill



Drill bit  
(Ø8)



Pencil

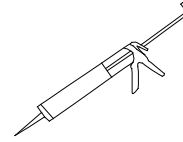

Silicone

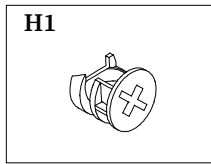

H1

16\*

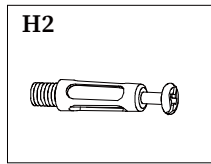

H2

16\*

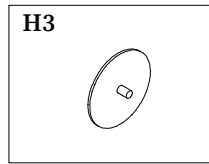

H3

16\*

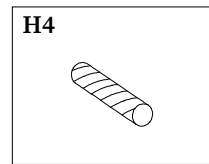

H4

36\*φ8\*30

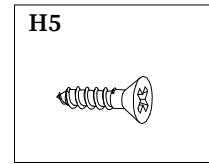

H5

24\*φ4\*16

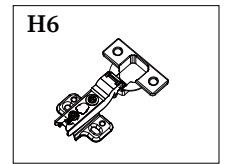

H6

4\*

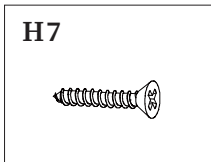

H7

8\*Ø4x28

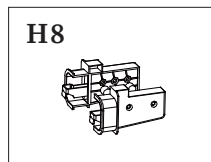

H8

2\*

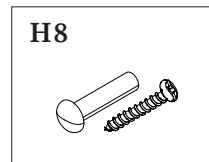

H8

2\*

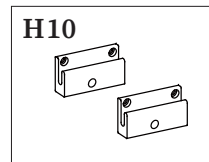

H10

1\*

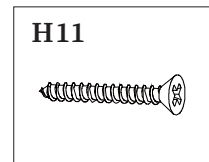

H11

6\*Ø4x50

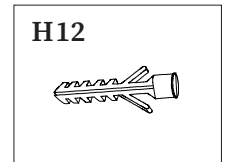

H12

6\*Ø8x40

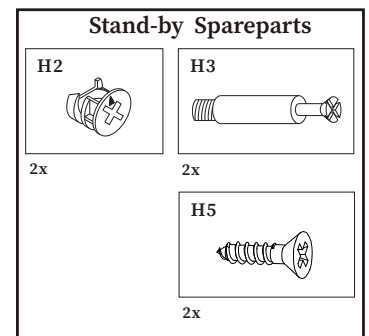
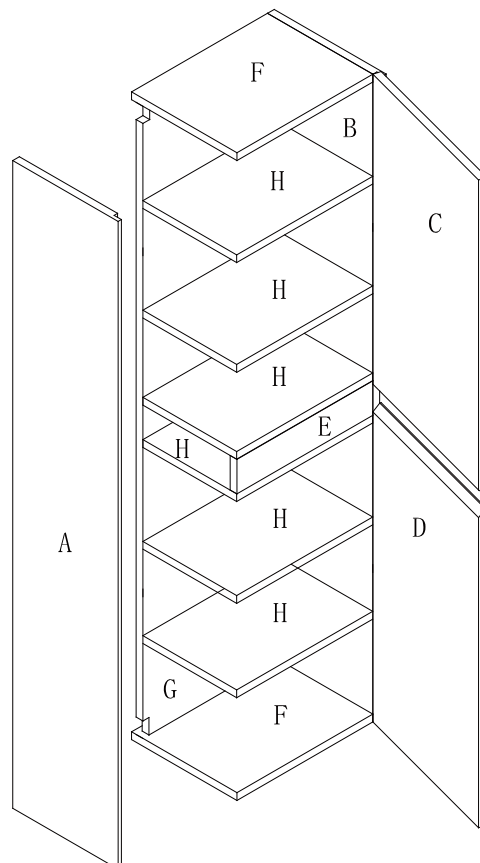

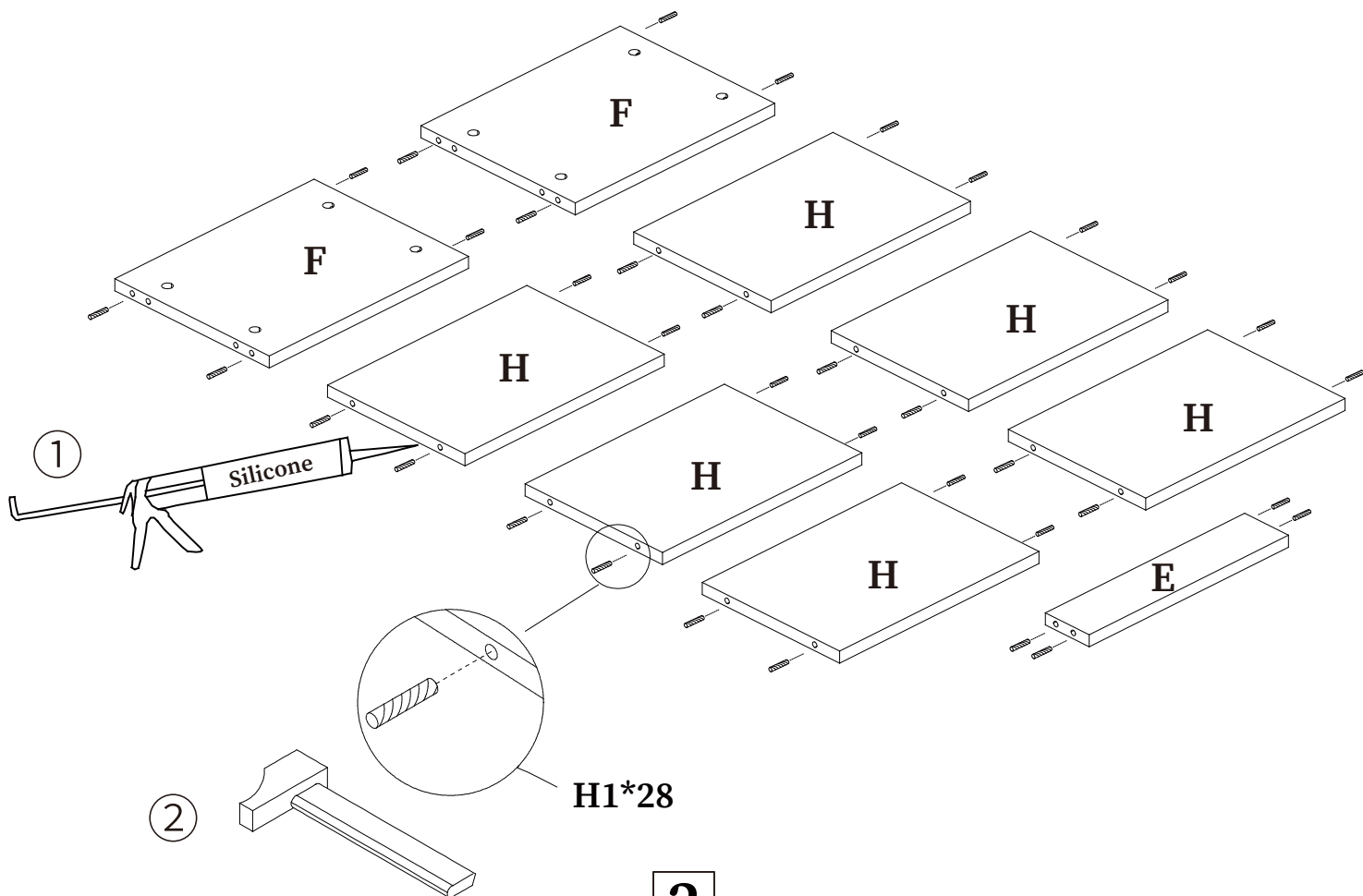
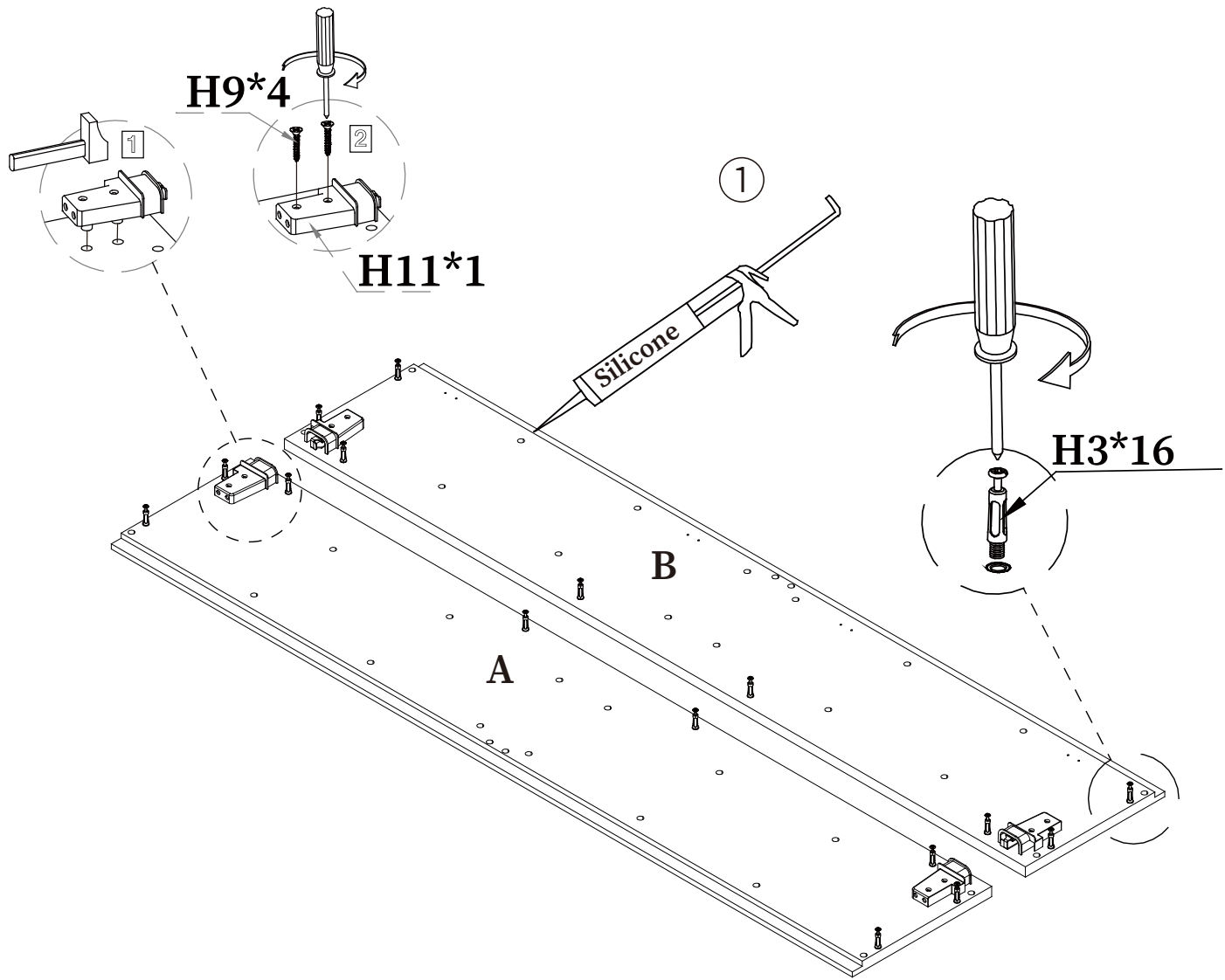

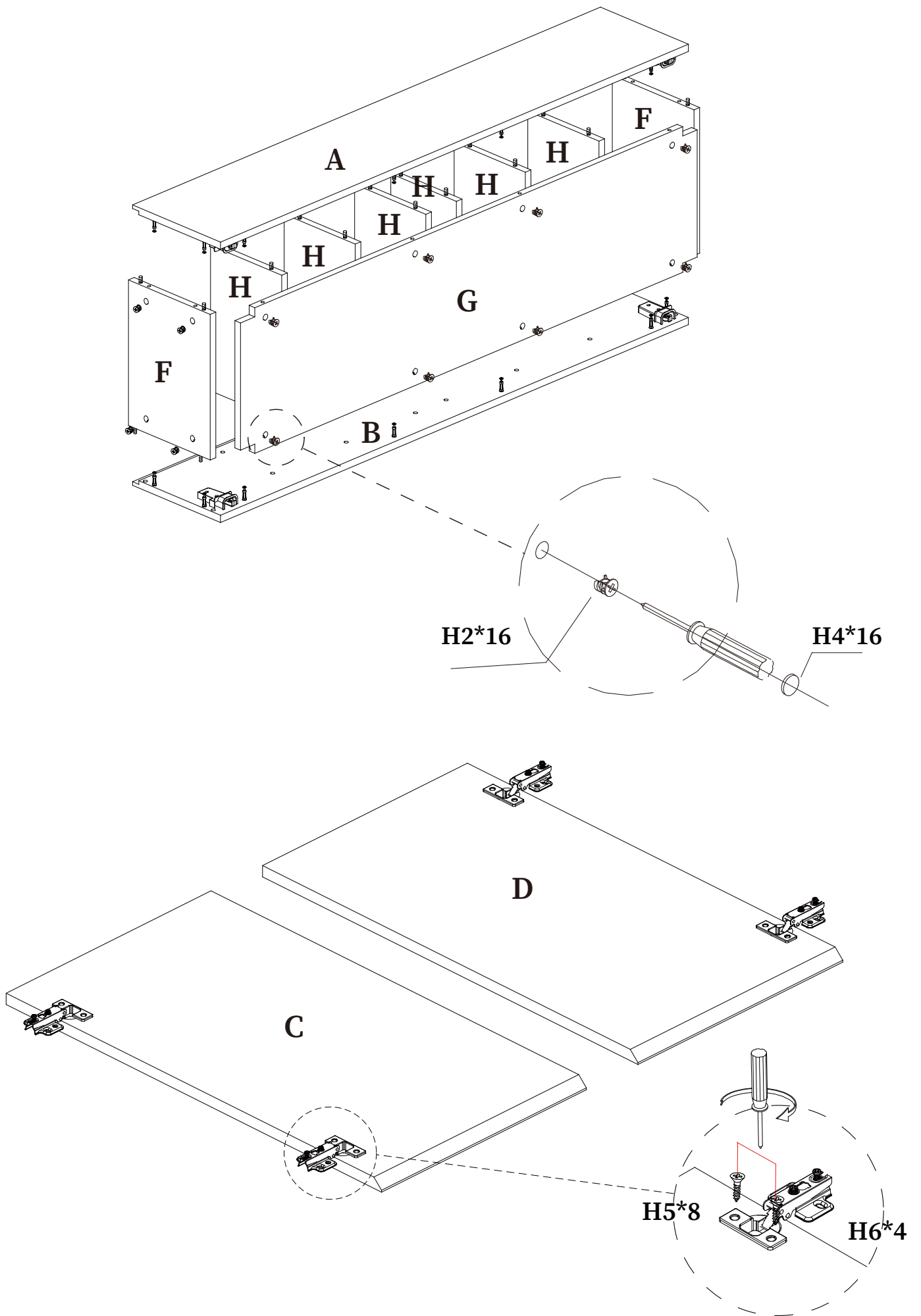

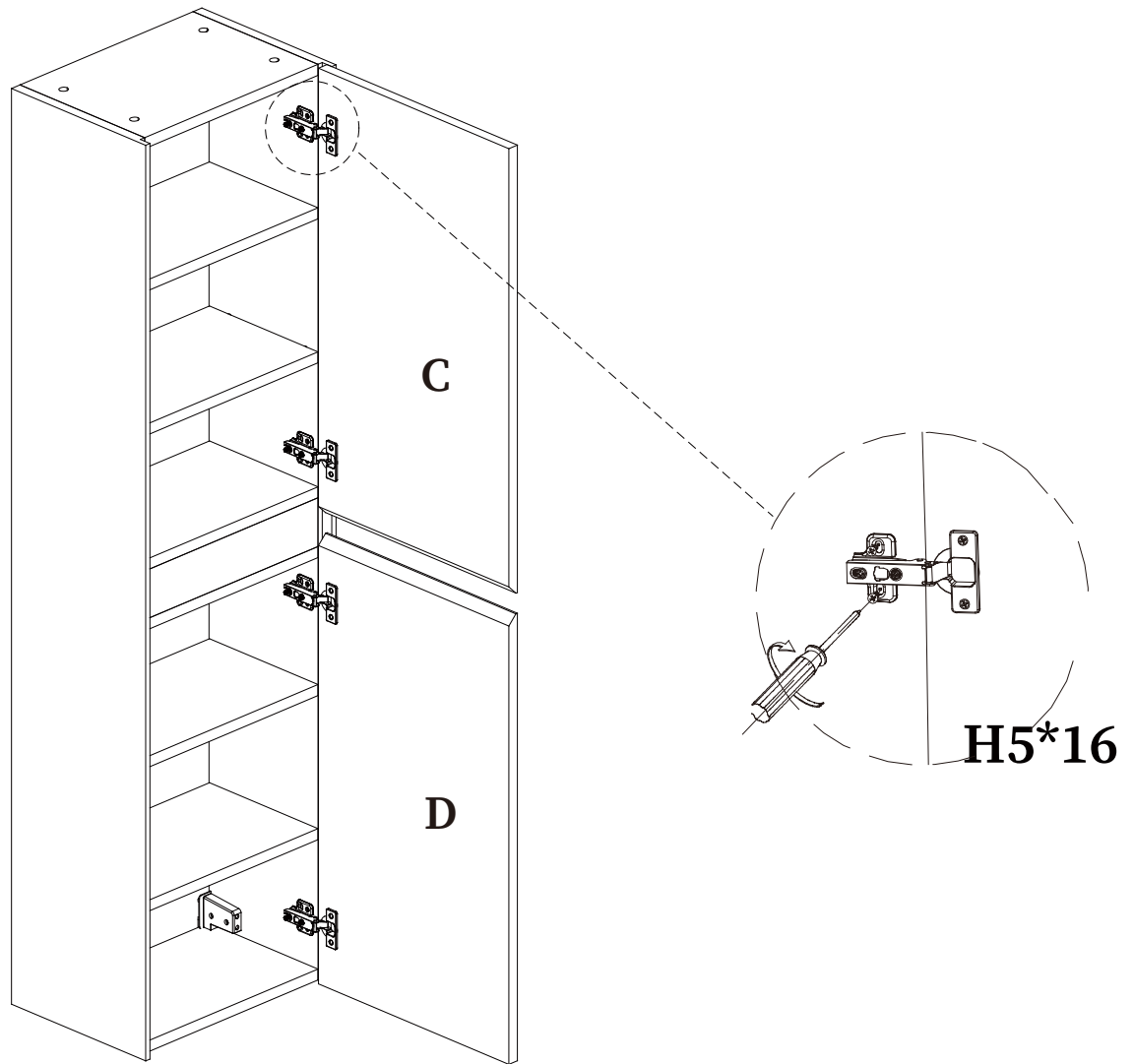

### REGLAGES DES PORTES

