

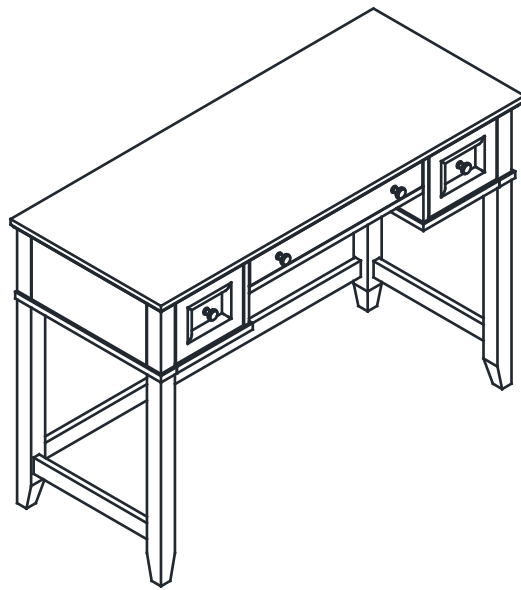

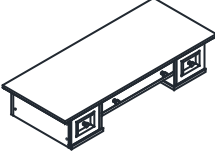

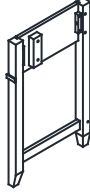



Vanity Desk



PART LIST

			
<p>Top Panel 1 PC</p>	<p>Left Panel 1 PC</p>	<p>Right Panel 1 PC</p>	<p>Bottom Stretcher 1 PC</p>

HARDWARE LIST

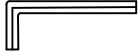
 <p>1-1/2"x Ø1/4"x D12</p>				
<p>Long Bolt 8 PCS (Extra 1)</p>	<p>Screw 2 PCS (Extra 1)</p>	<p>Spring Washer 8 PCS (Extra 1)</p>	<p>Flat Washer 8 PCS (Extra 1)</p>	<p>Wood Dowel 2 PCS (Extra 1)</p>
 <p>Allen Wrench 1 PC</p>				

ADDITIONAL TOOLS (Not Provided)

Note: It is not recommended to use power tools during assembly.







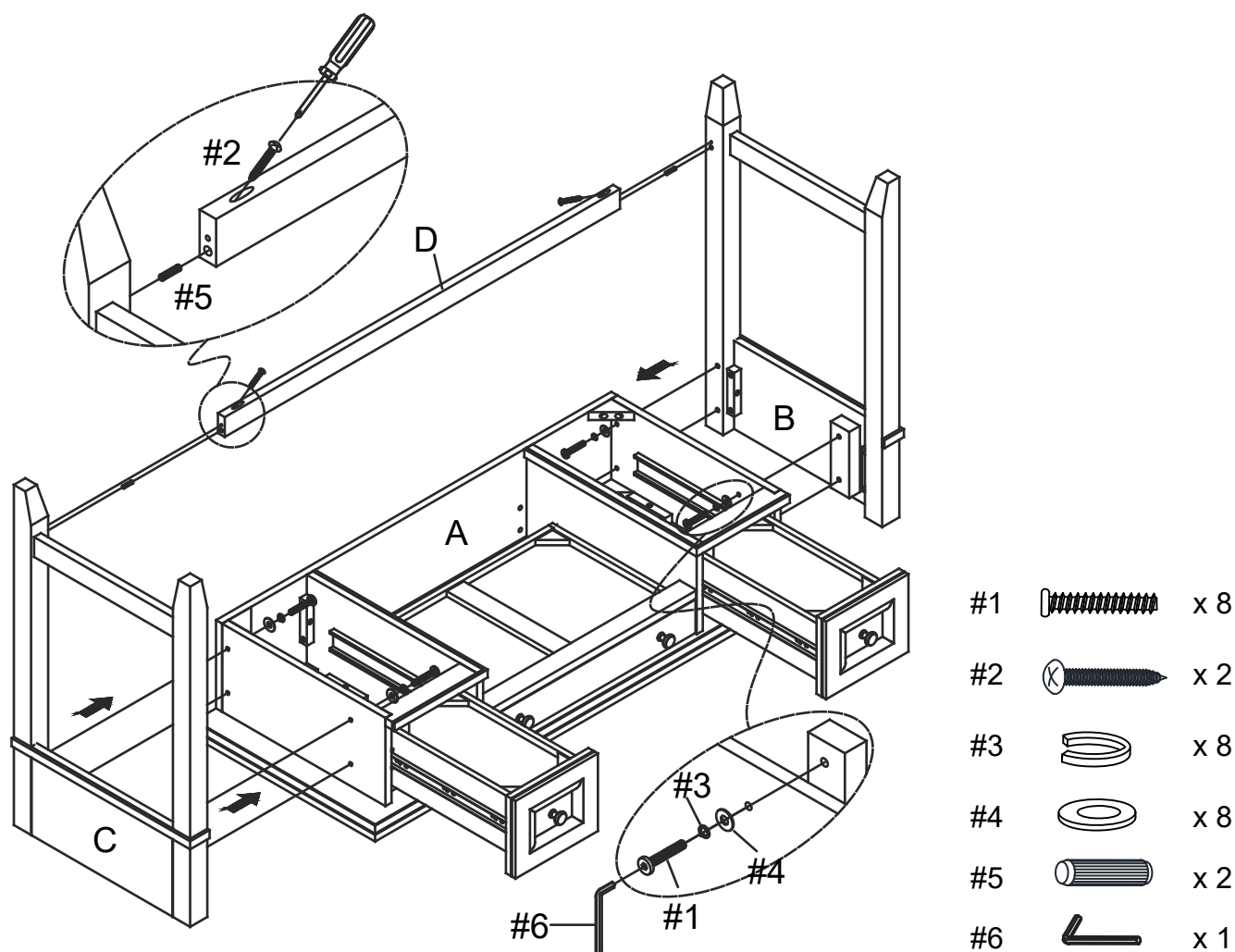

Phillips Head Screwdriver

Note: Wood dowels are intended for alignment. Additional clearance between wood dowel and pre-drilled hole is intentional for ease of assembly.

Step 1. Carefully turn top panel (part A) upside down on a soft flat surface, such as carpet, as shown below. Open drawers, attach left panel (part B) to top panel (part A) using long bolts (part #1), spring washers (part #3), flat washers (part #4) and allen wrench (part #6). Attach bottom stretcher (part D) to left panel (part B) using wood dowel (part #5), screw (part #2) and phillips head screwdriver. Attach right panel (part C) to bottom stretcher (part D) and top panel (part A) using wood dowel (part #5), screw (part #2), long bolts (part #1), spring washers (part #3), flat washers (part #4), allen wrench (part #6) and phillips head screwdriver.



- #1  x 8
- #2  x 2
- #3  x 8
- #4  x 8
- #5  x 2
- #6  x 1

Step 2. Carefully turn unit upright.

