

Assembly Instructions

⚠ Before you throw the carton, please ensure that you have all the parts needed for the assembly.

⚠ **Hardware Note:**

1. For each step please don't fully tighten all the screws at first, when they all align to the holes you can fully tighten them.

2. All the bolts should be assembled **vertically** to the holes.

⚠ Legs and hardware can be found in the **bottom** of the seat. We attached velcro on the black fabric.

⚠ **Spare parts can be found in the hardware box** if you do not have enough bolts for assembly.

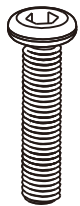

2pcs



4pcs

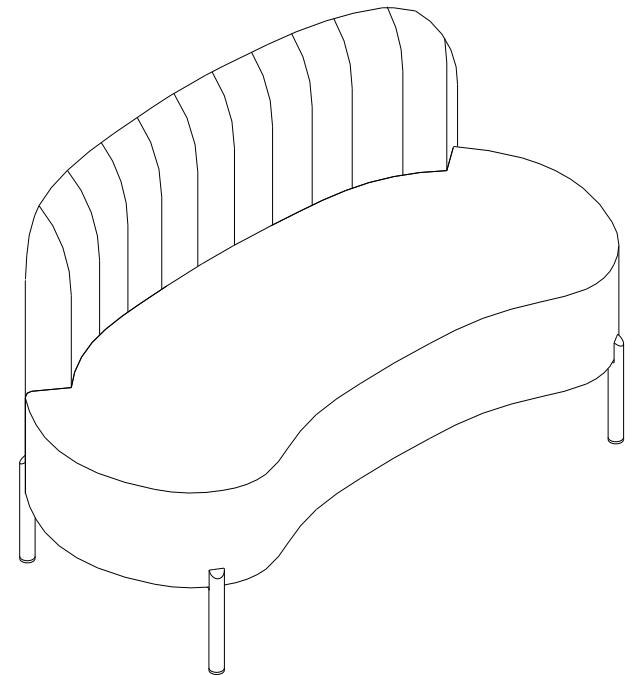

⚠ THIS INSTRUCTION BOOKLET CONTAINS IMPORTANT SAFETY INFORMATION. PLEASE READ AND KEEP FOR FUTURE REFERENCE.

Assembly Instructions

Parts and Hardware

Please check to make sure you have all parts and hardware before starting assembly process.

Ⓐ

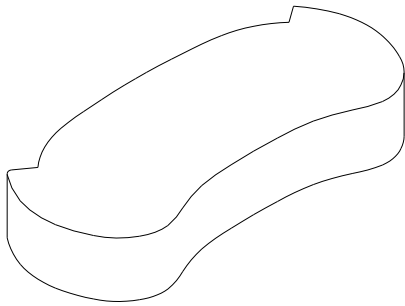

Seat 1pc

Ⓑ

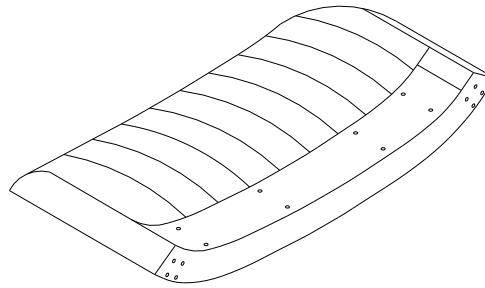

Back 1pc

Ⓒ

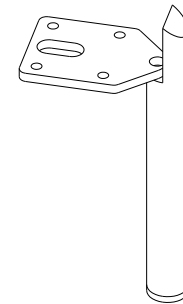

Leg 4pcs

①

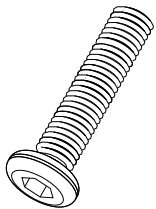

Long bolts
8pcs

②

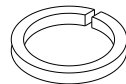

Spring washers
8pcs

③

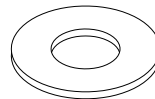

Flat washers
8pcs

④

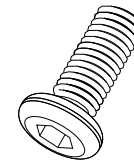

Short bolts
16pcs

⑤

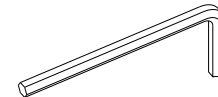

Wrench 1pc

Assembly Instructions

Assembly Instruction

Step 1: Assemble seat to back use bolt ①, spring washer ② and flat washer ③. Do not fully tighten any single bolts until all the bolts are align to the holes, then fully tighten them by the short side of wrench.

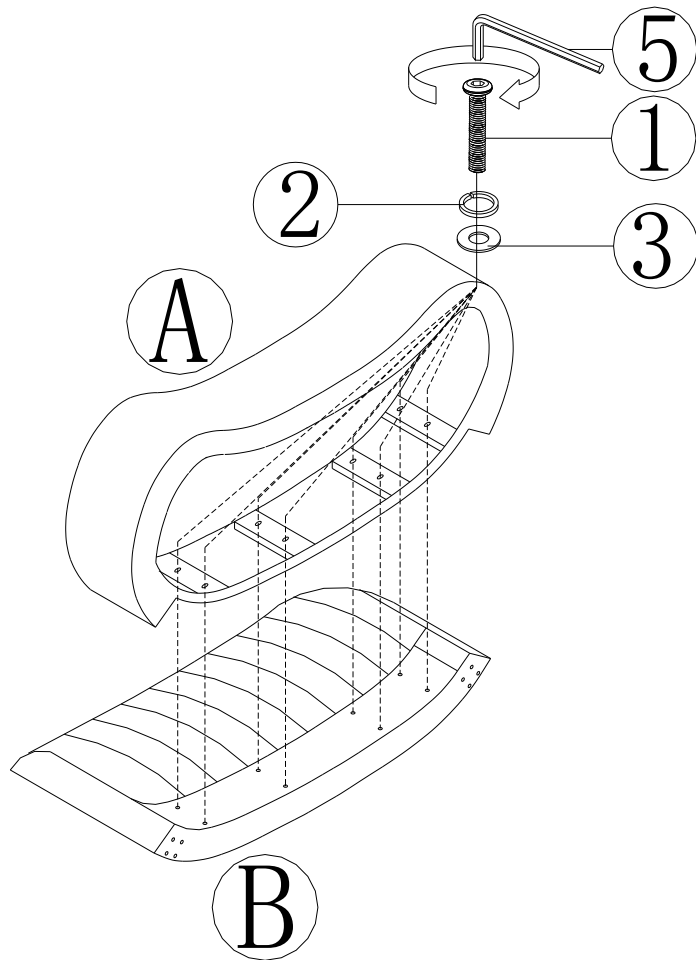

Step 2: Assemble legs to the bottom of seat. Do not fully tighten any single bolts until all the bolts are align to the holes, then fully tighten them by the short side of wrench.

