

**ASSEMBLY INSTRUCTIONS
NOTICE DE MONTAGE**

**Place tracking label here
Placez l'étiquette de garantie ici**

- ** Please keep these instructions, and have the product model #, and part # available when requesting a service.
- ** Veuillez conserver ce notice de montage, et avoir en main le numéro du modèle, et de la pièce pour fin de service.

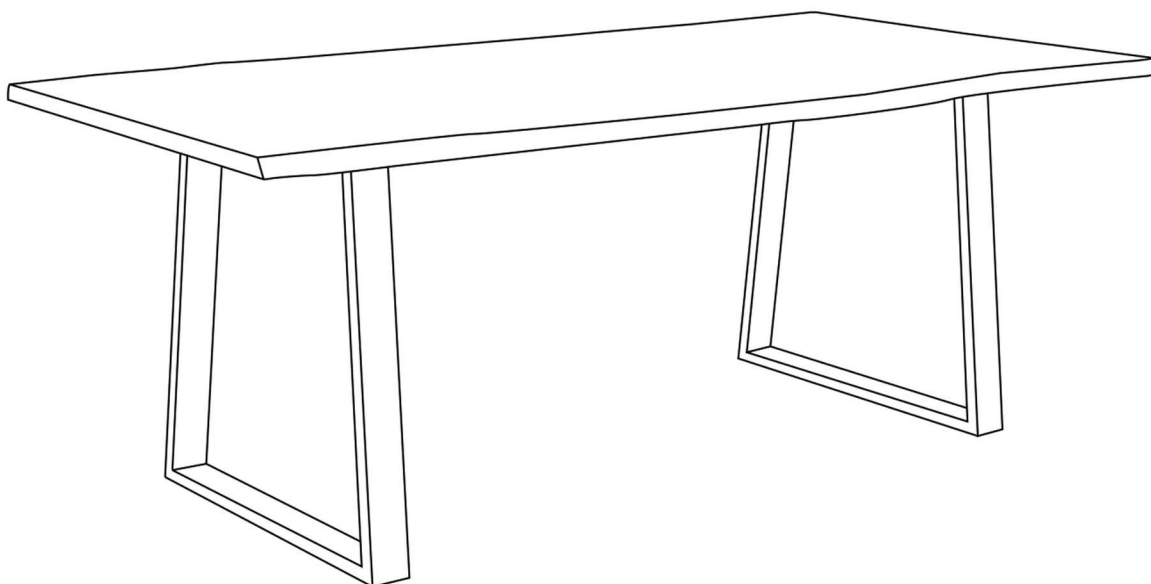

IMPORTANT NOTE

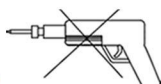

Do not use a power tool to assemble this product as it could damage the thread of the hardware and affect the solidity/durability of the product.



NOTE IMPORTANTE

Ne pas utiliser d'outil électrique pour assembler ce produit car cela pourra endommager le filet des quincailleries et par le fait même affecter la solidité/durabilité du produit.

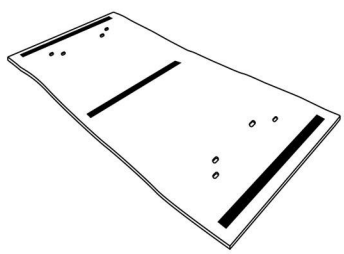
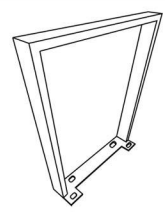
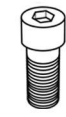
Dining Table Top - Base

1  1X	29838-02-8400-00002		29838-02-8400-00001		
	2  2X	A  8X	B  8X	C  1X	

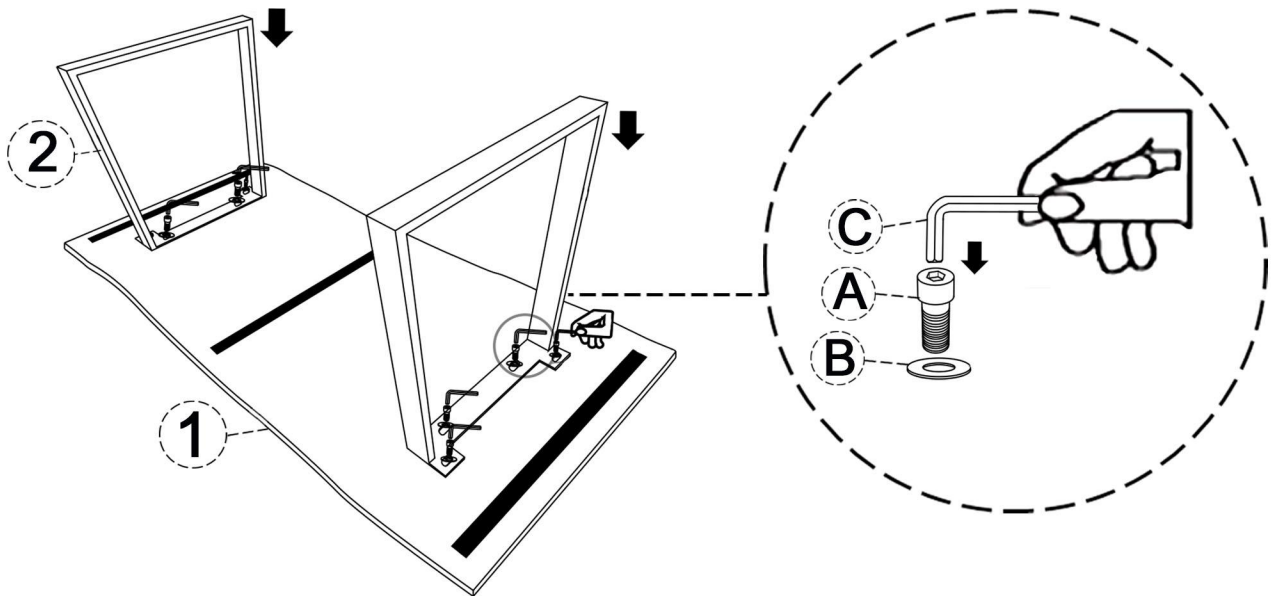

Step / Étape 1

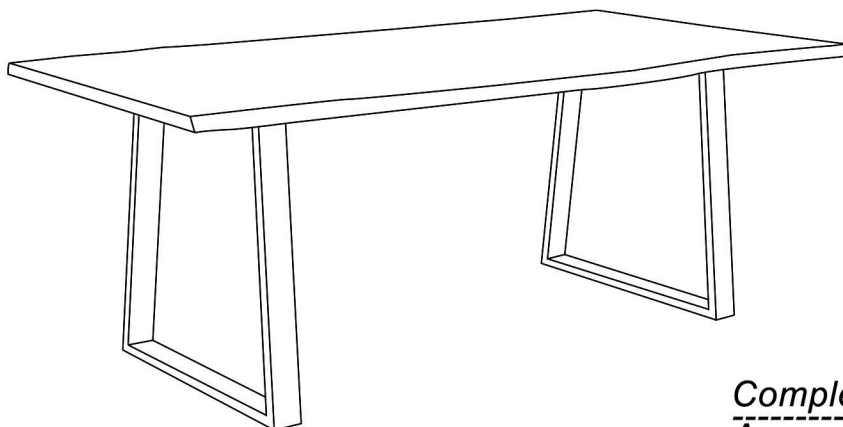

Completely Assembled
Assemblage Completé