

---

## ASSEMBLY INSTRUCTIONS

# PARTS AND HARDWARE

Avoid using sharp objects such as a knife to cut open packing as you may accidentally damage the upholstery.

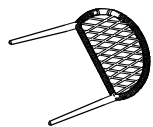

A:2PCS  
Left Arm

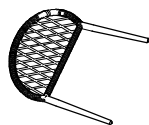

B:2PCS  
Right Arm

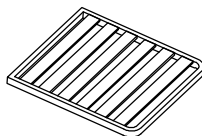

C:2PCS  
Seat

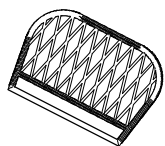

D:2PCS  
Backrest

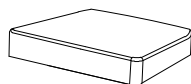

E:2PCS  
Seat Cushion

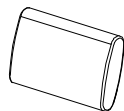

M:2PCS  
Back Cushion

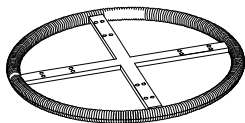

F:1PC  
Table Top



G:1PC  
Table Glass



H:4PCS  
Table Leg



M6\*40  
J:16PCS  
Bolt and washer

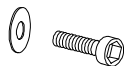

M6\*15  
L:8PCS  
Bolt and washer



K:1PC  
Allen Key

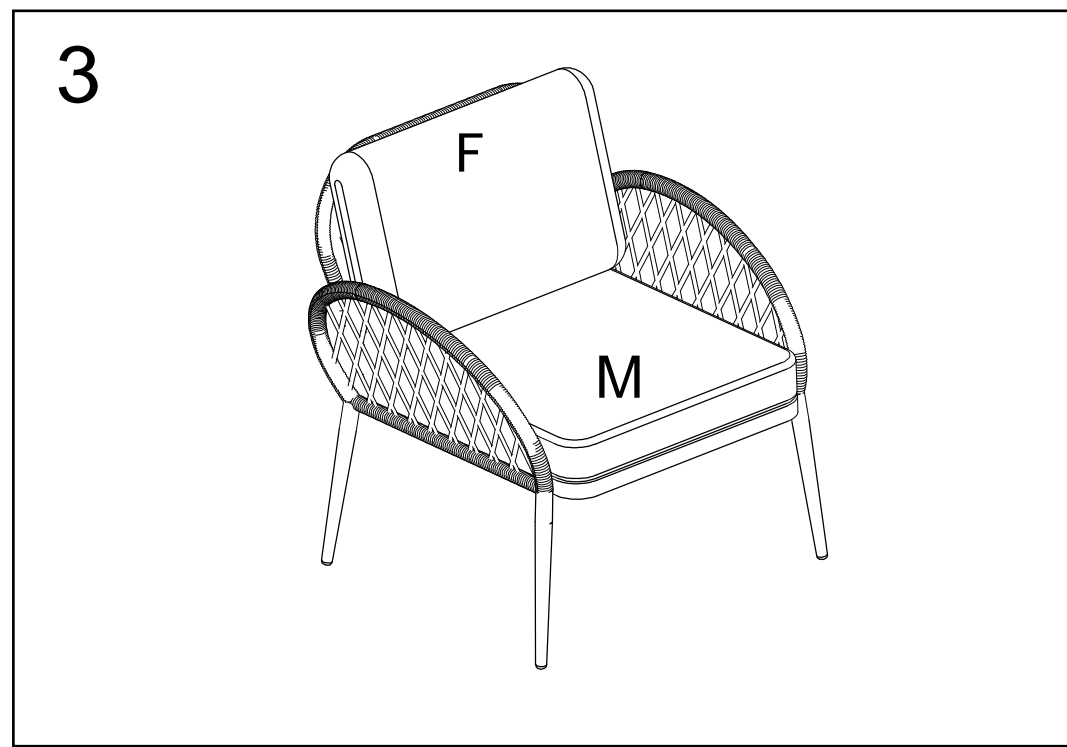
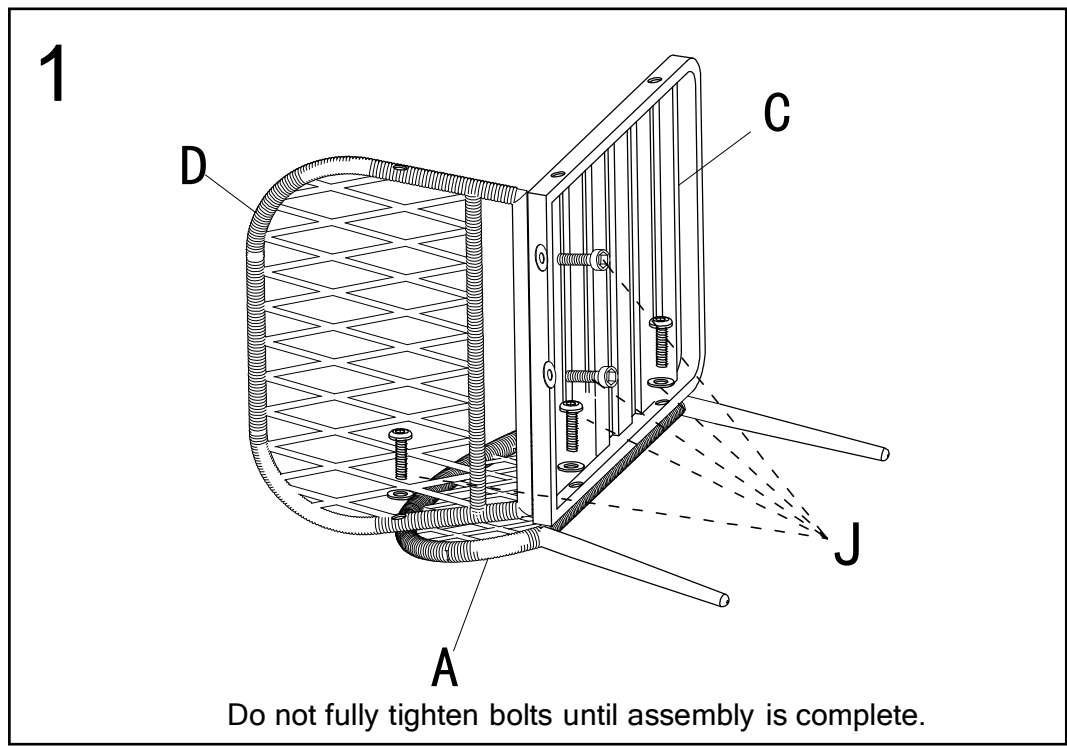
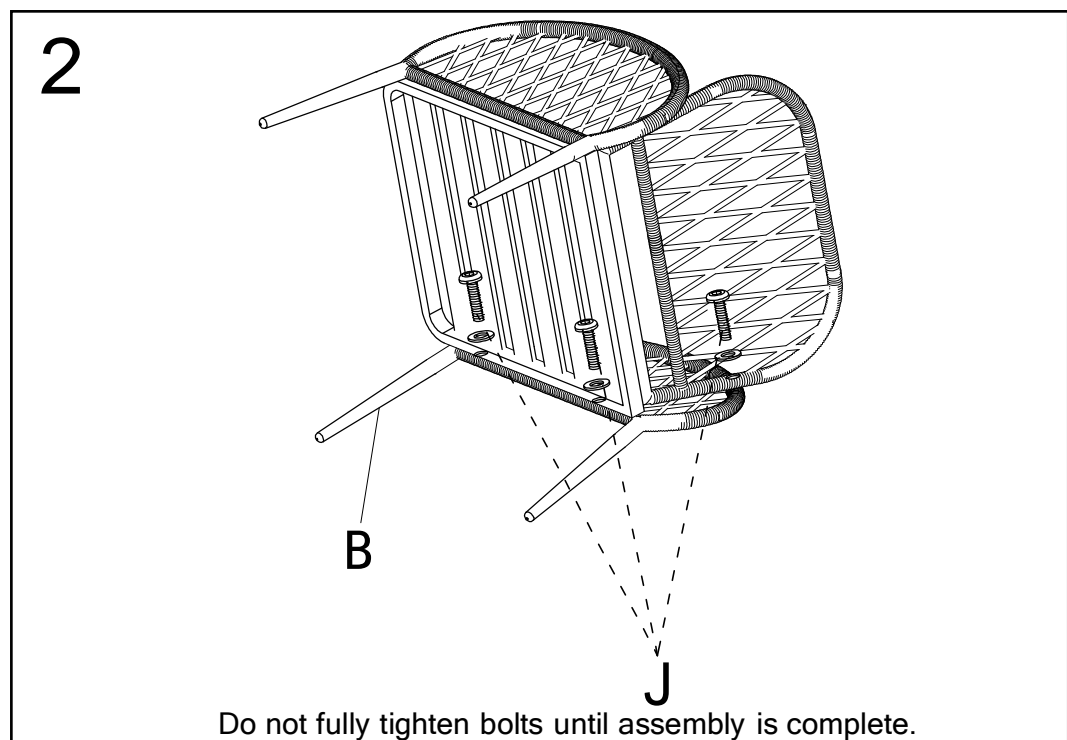
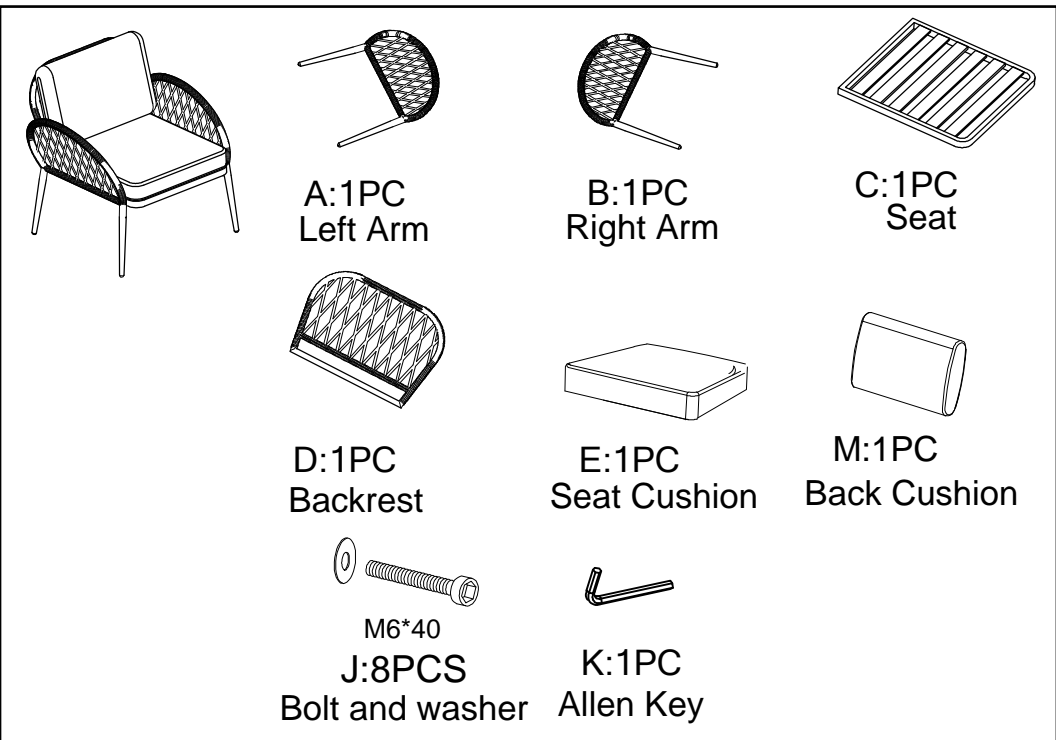

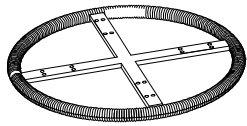
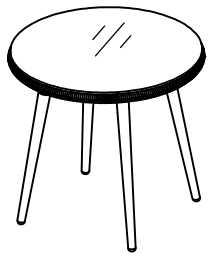

F:1PC  
Table Top



G:1PC  
Table Glass



H:4PCS  
Table Leg

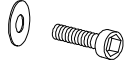

M6\*15  
L:8PCS  
Bolt and washer



K:1PC  
Allen Key

5

G

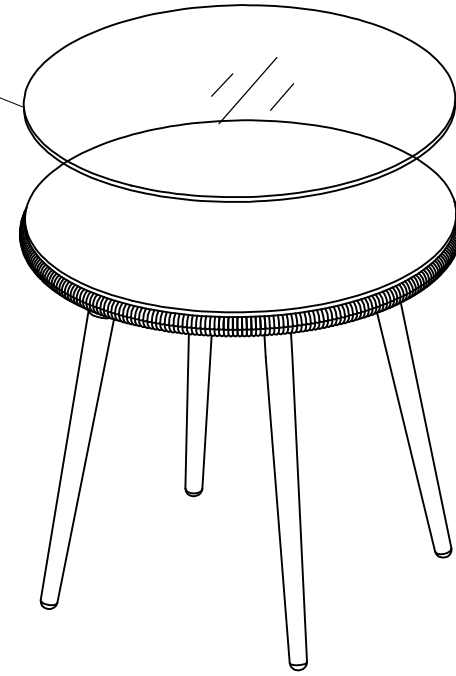

4

