

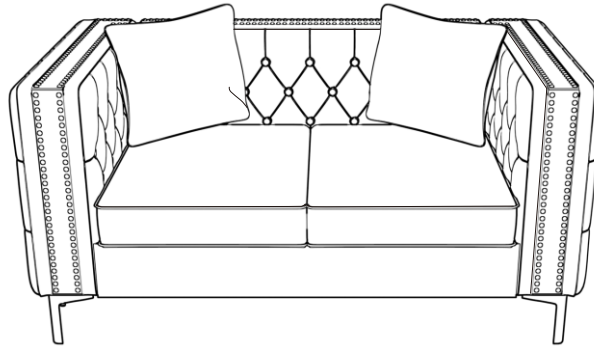

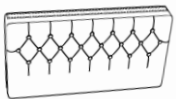

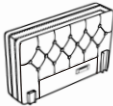

Assembly Instructions



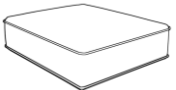

Loveseat

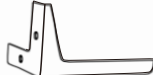

PARTS LIST

			
A x1	BL x1	BR x1	C x2
			
D x2	E x1	F x1	G Leg x4

HARDWARE LIST

			
1 Bolt x8	2 Spring Washer x8	3 Washer x8	4 Allen Wren x1

Step 1

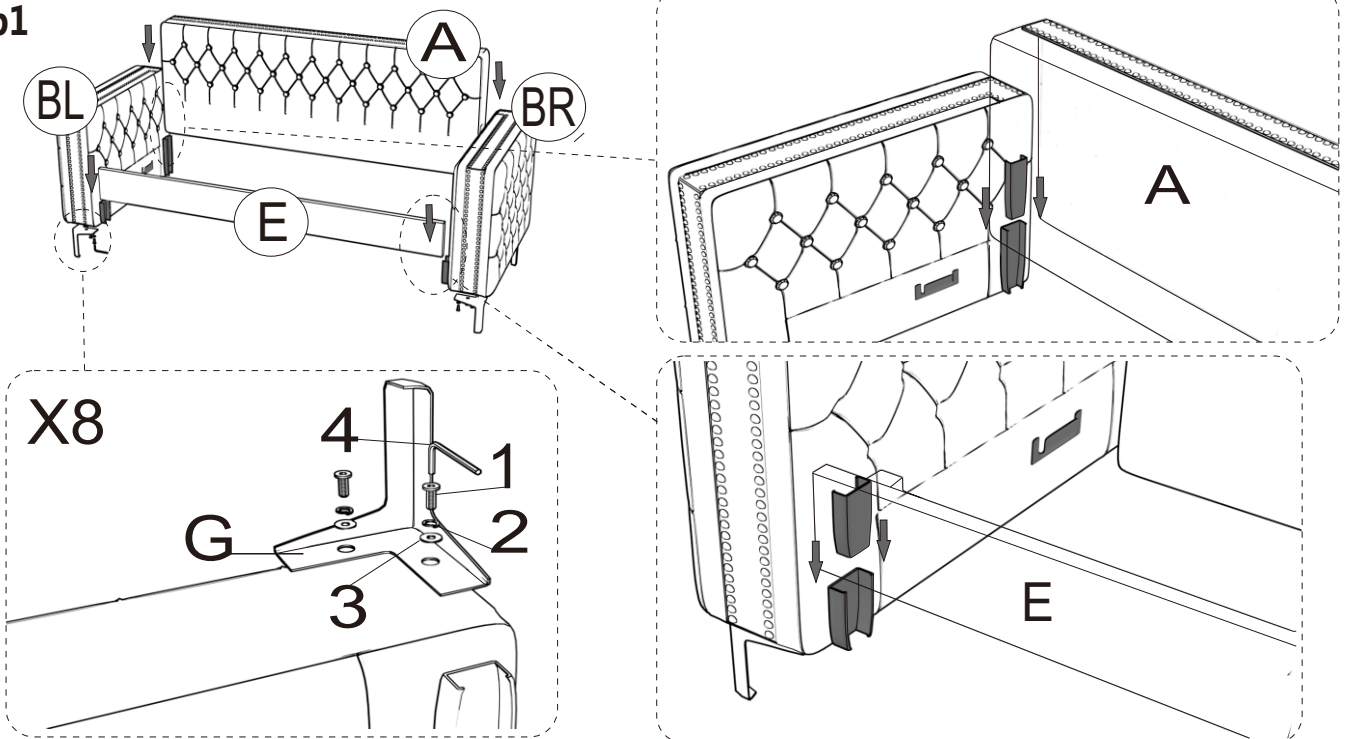

Step2

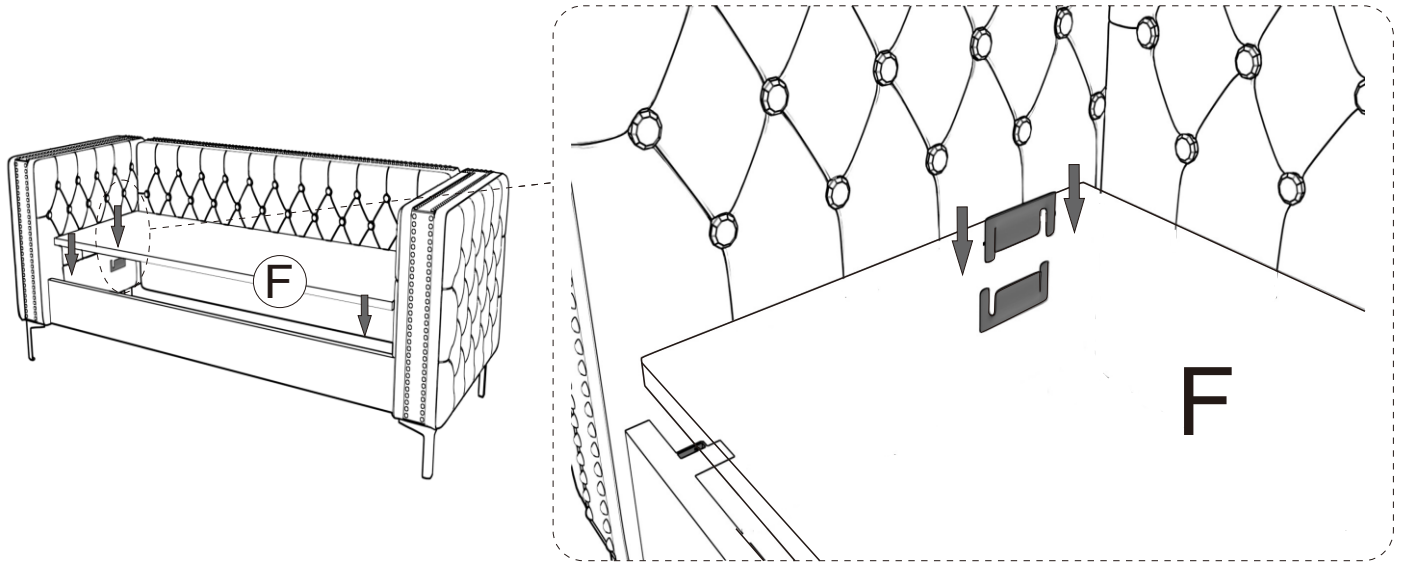

Step3

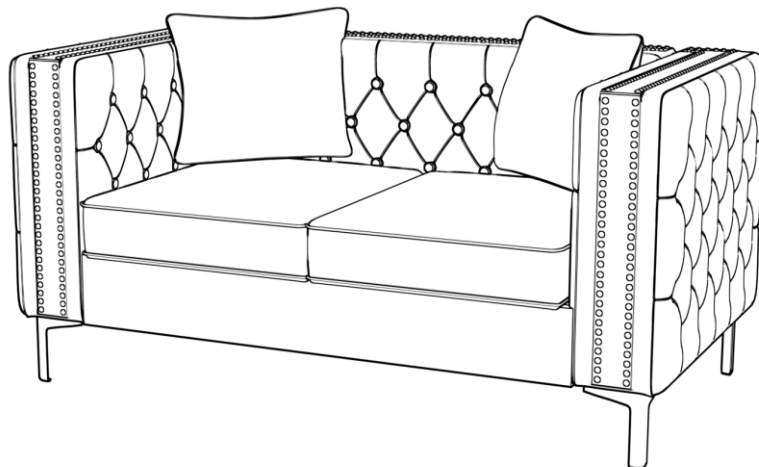
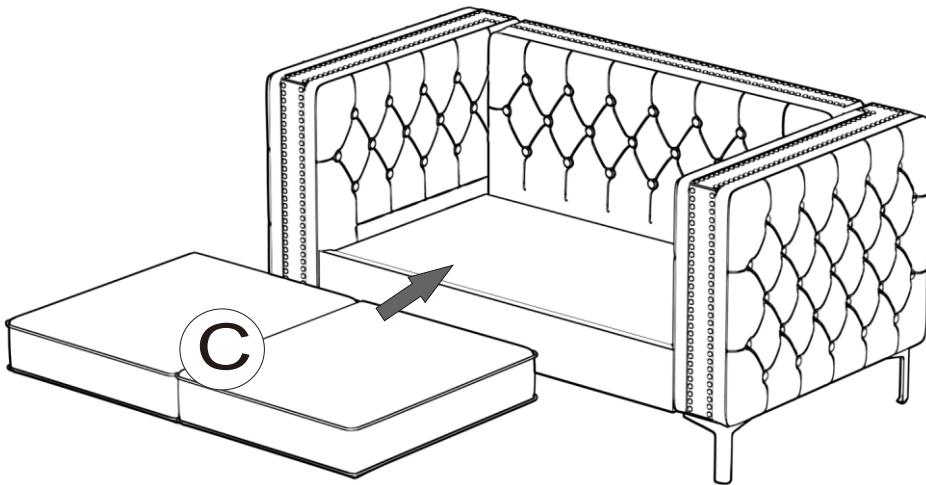

D x2