

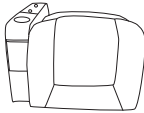

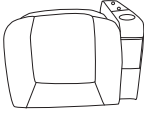

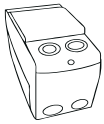



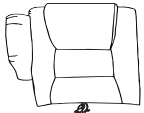

Assembly Instruction

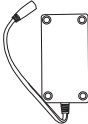
NO.	DRAWING	QTY	DESCRIPTION
A		1	LSF SEAT
B		1	RSF SEAT
C		1	CONSOLE
D		2	LSF AND RIGHT ARM
E		1	LSF BACK REST
F		1	RSF BACK REST
G		1	CONSOLE BACK REST
H		1	POWER SOURCE
I		1	CONNECTION WIRE
J		1	Y-CABLE
K		2	CONNECTOR
L		8	NUT
M		4	PLASTIC PAD
N	 M6x30	8	SCREW
O		1	ALLEN KEY

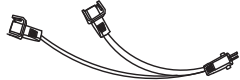
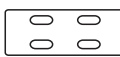
STEP 1

Turn over the base and you will find that the power cord and LED Light connection are binding by four cable ties. Please cut off # 1# 2# 3# 4 cable straps.

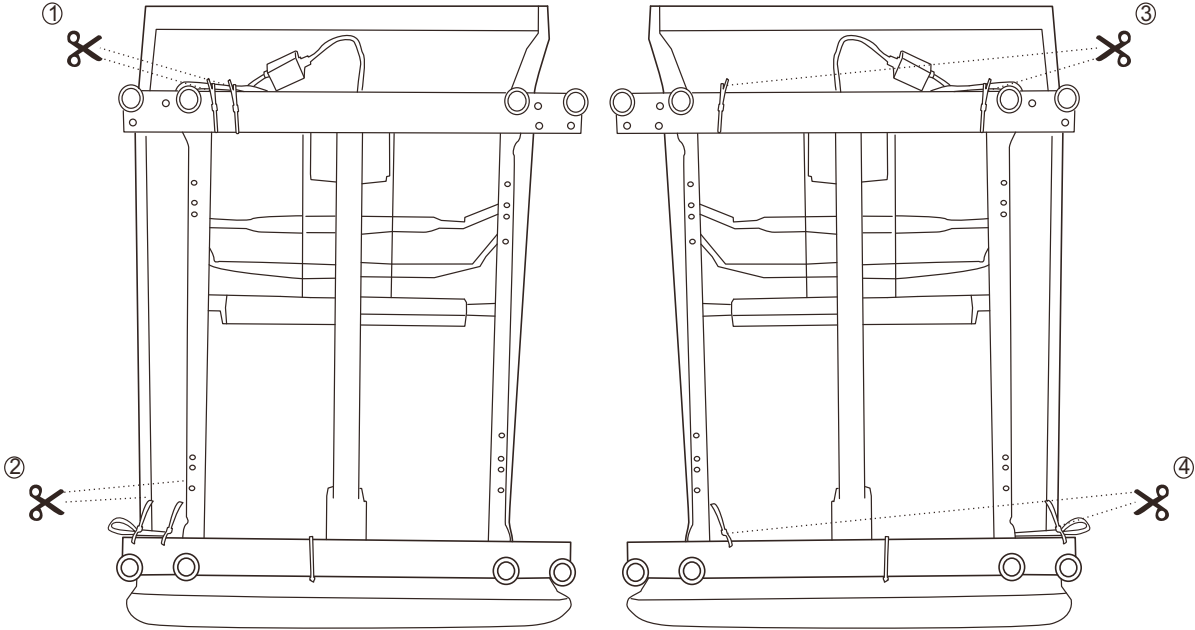

STEP 1

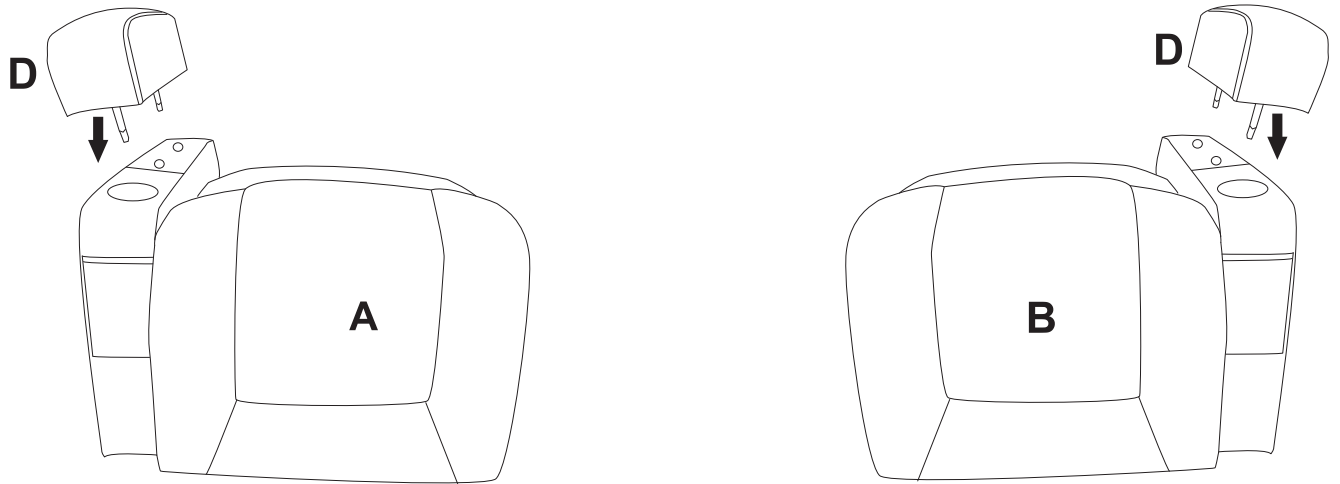

STEP 2

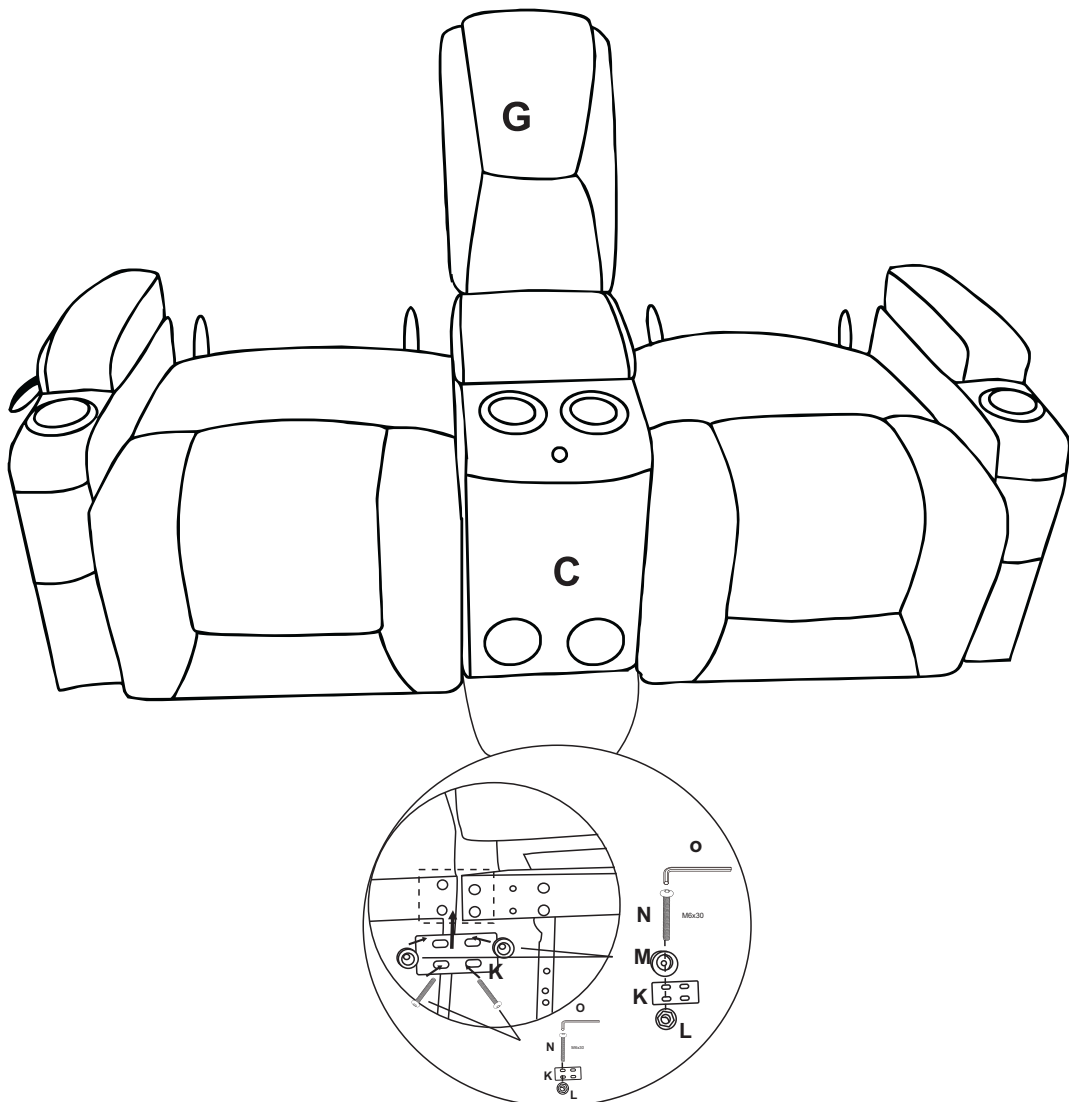

STEP 3

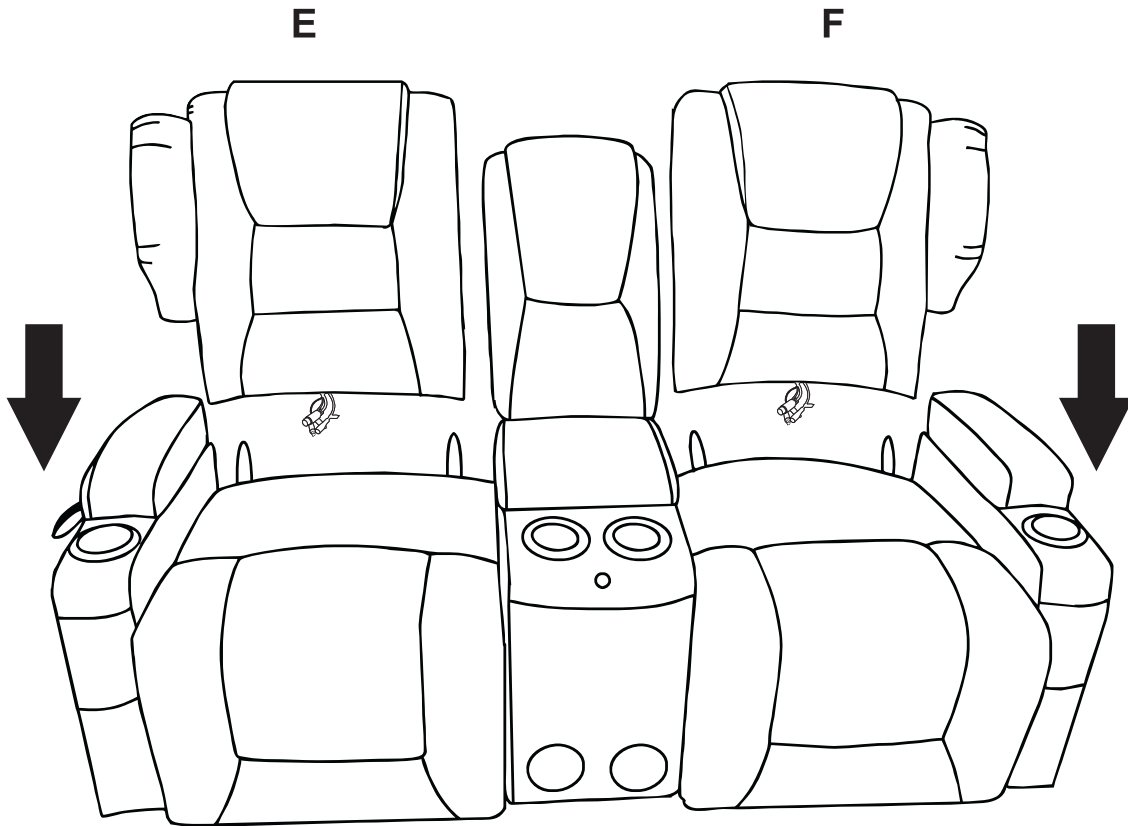

STEP 4

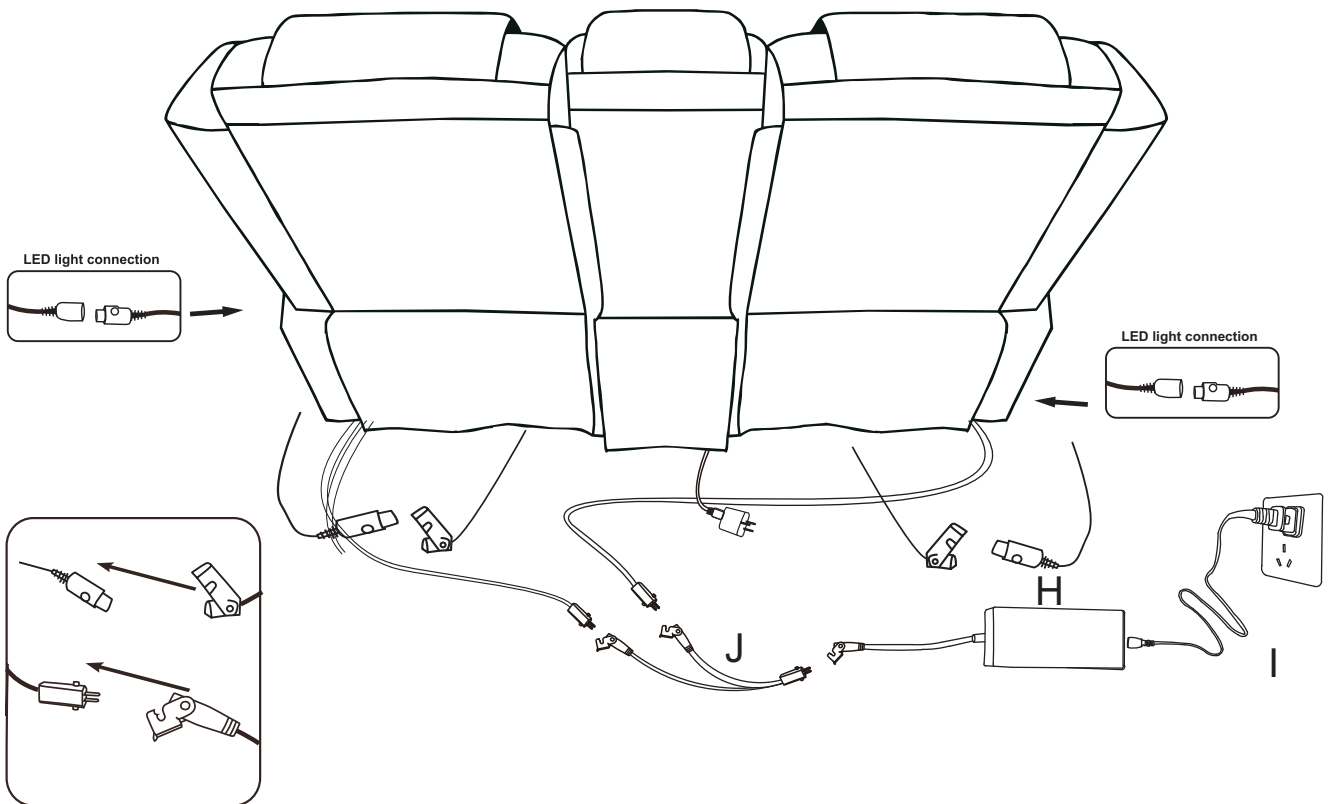

STEP 5

How to recline

Warning: Do not sit or hit the footrest after lift up.

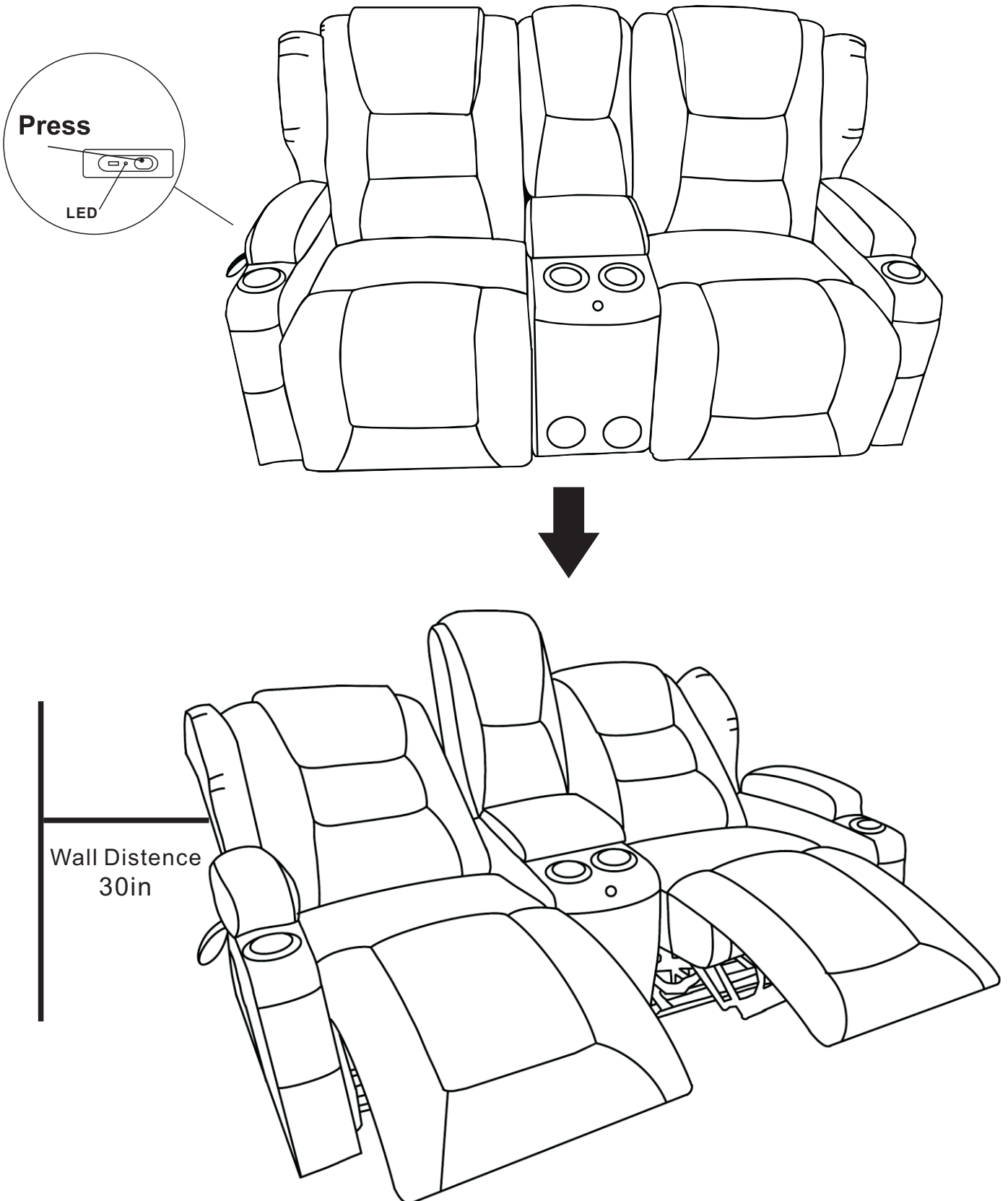

Warning

Do not sit/kick/stand on the footrest after lift up

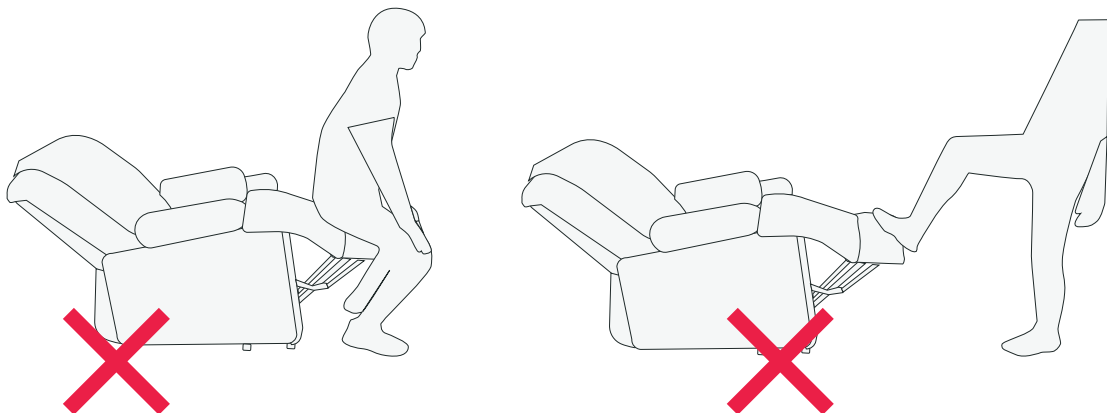
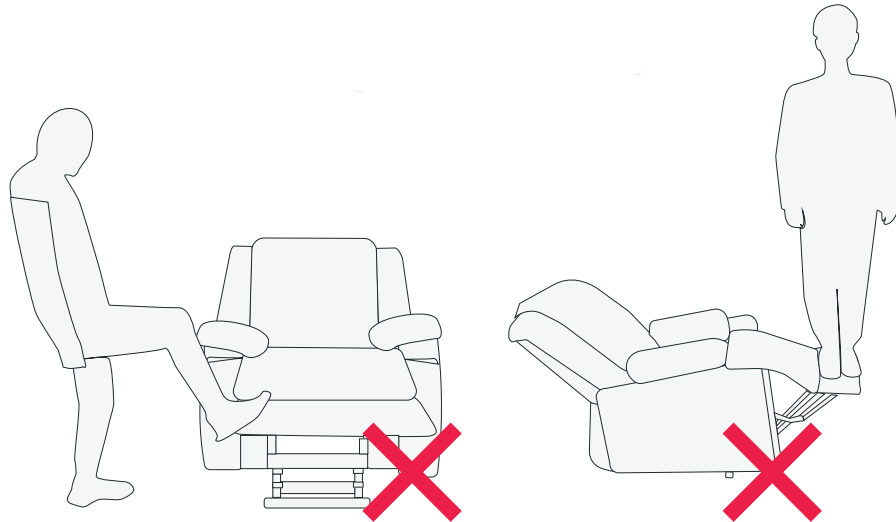

Leave enough space between chair back and wall before reclining

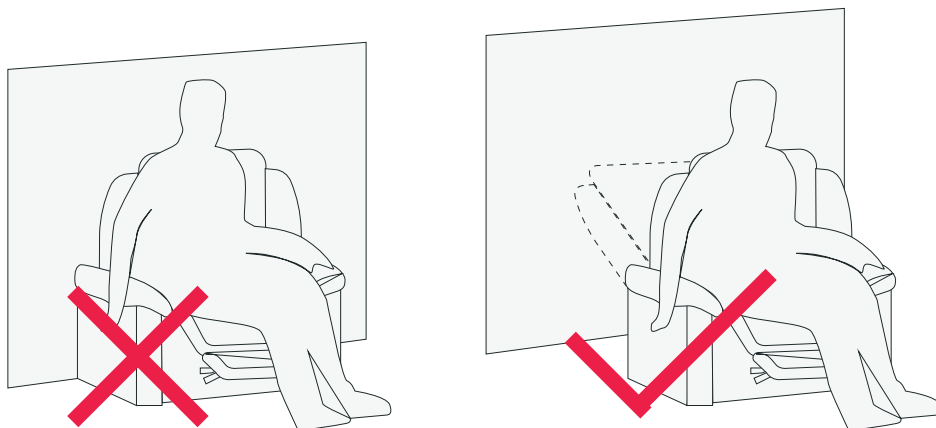

Warning

Leave enough space between chair back and wall before recline

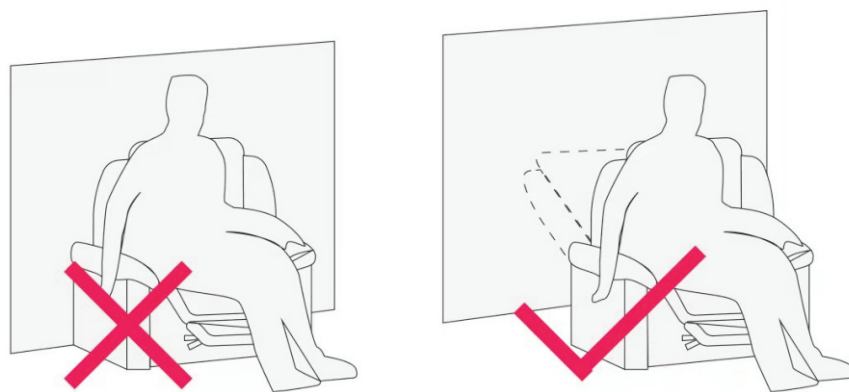

2-Person lift

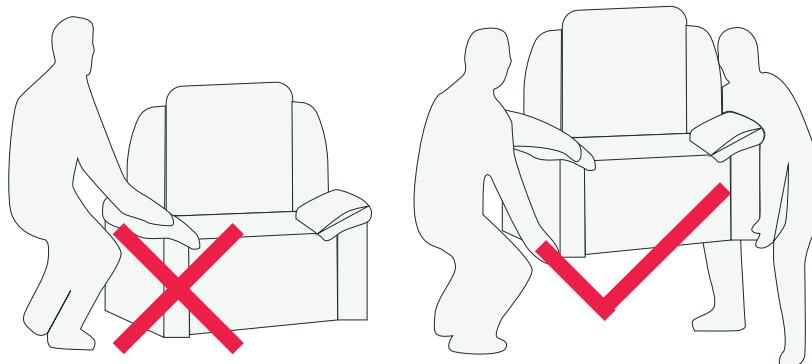

Do not move chair when it's reclining

