

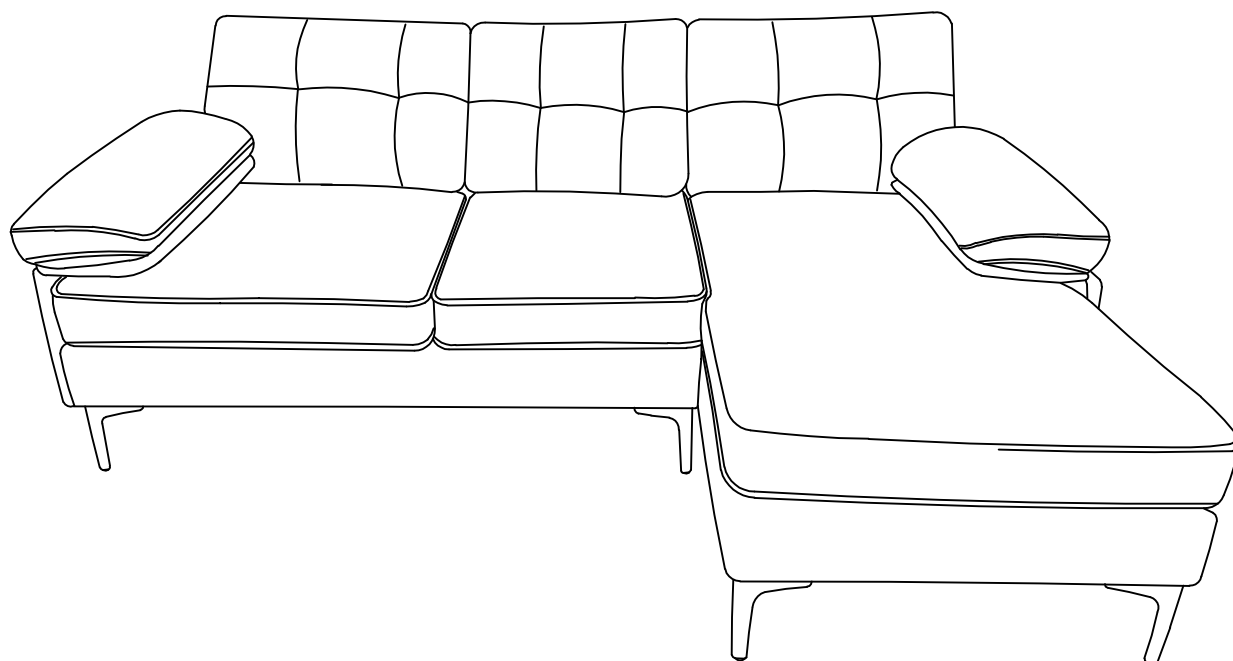

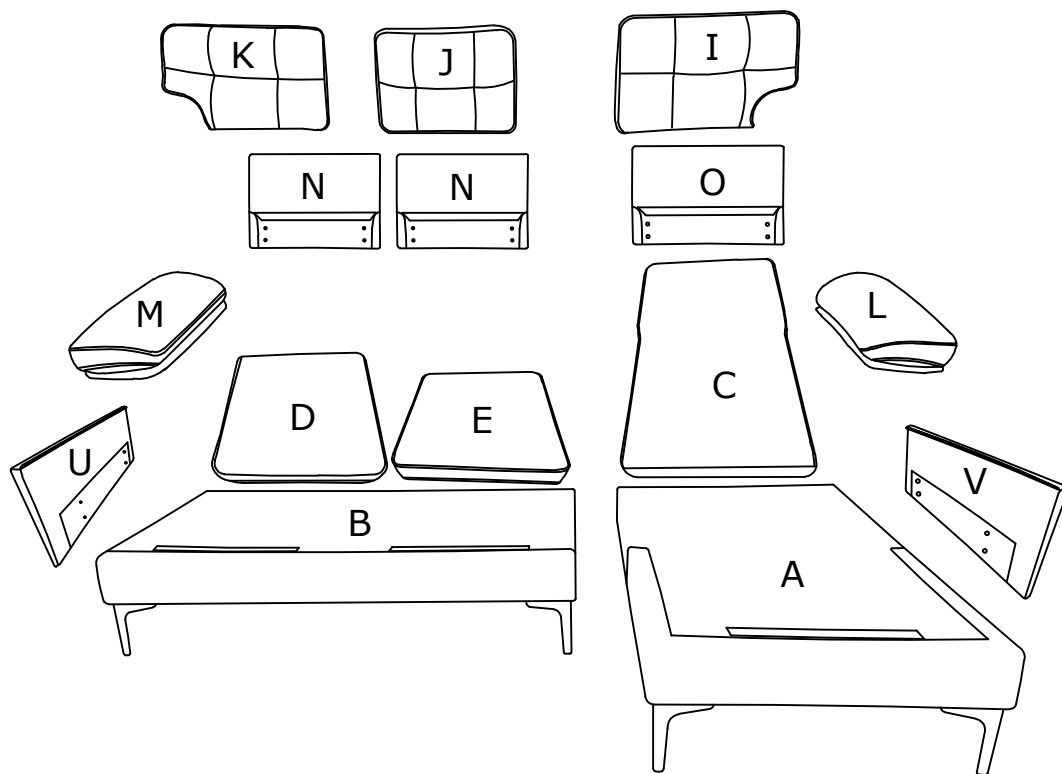





INSTRUCTION MANUAL

L SHAPED SECTIONAL





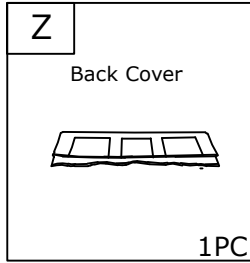
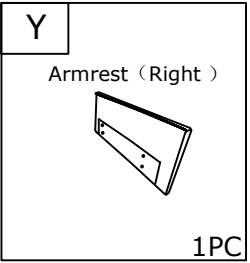
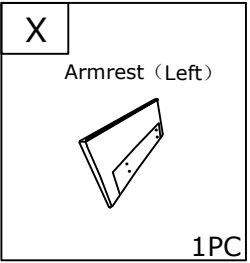
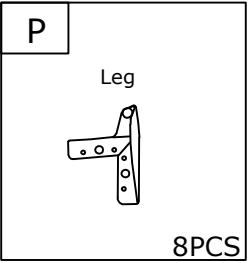
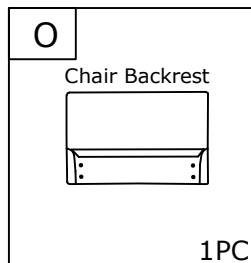
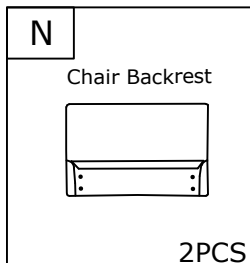
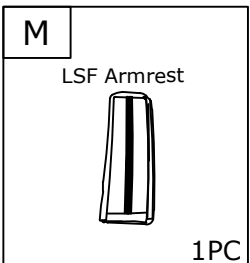
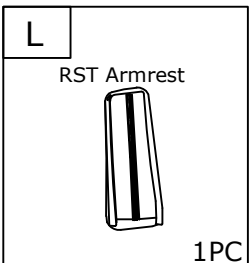
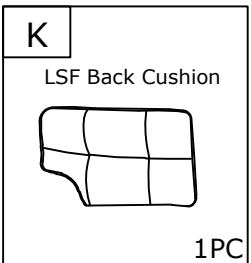
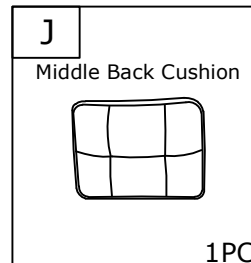
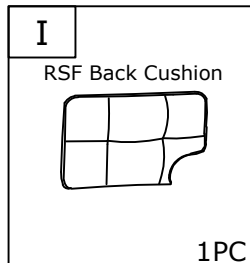
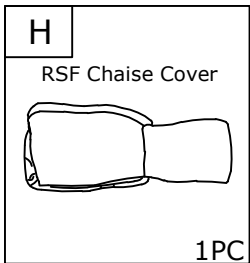
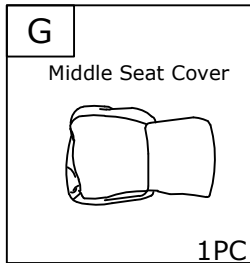
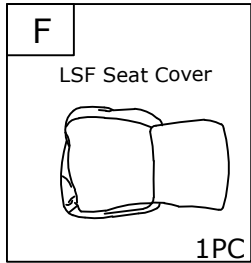
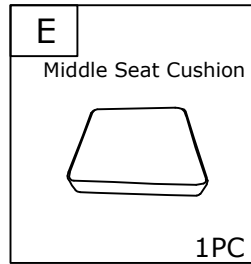
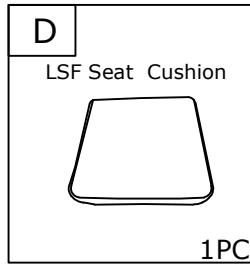
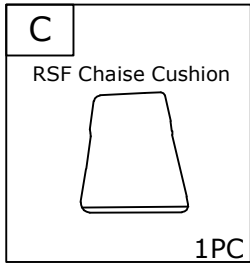
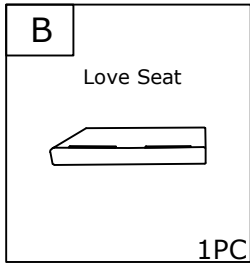
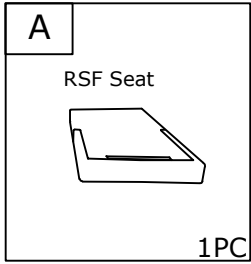

- P  8X Sofa Leg
- Q  16X Bolt 8*20mm
- R  12X Bolt 8*60mm
- S  2X Bolt 8*80mm
- T  8X Bolt 8*80mm
- U  6X Butterfly Nut
- V  22X Flat Washer
- W  1X Allen Key

TOOLS REQUIRED:  SCISSORS (NOT INCLUDED)



STEP 1

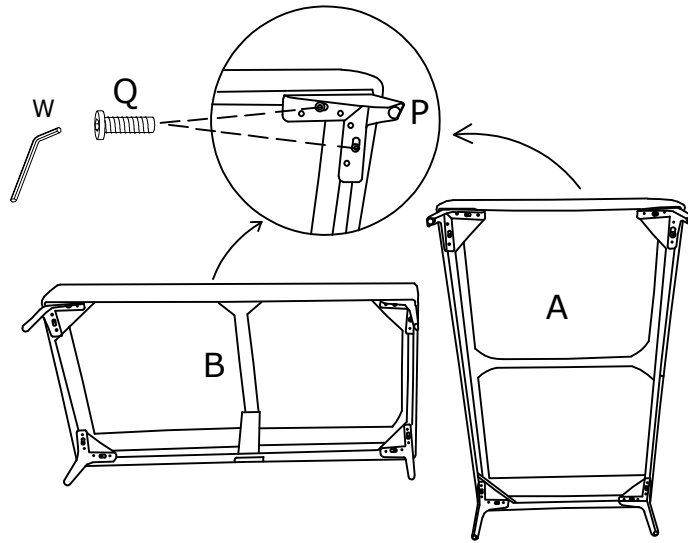

Assemble iron leg (P) with screws (Q).

Q	 M8X20mm	16PCS
P		8PCS



STEP 2

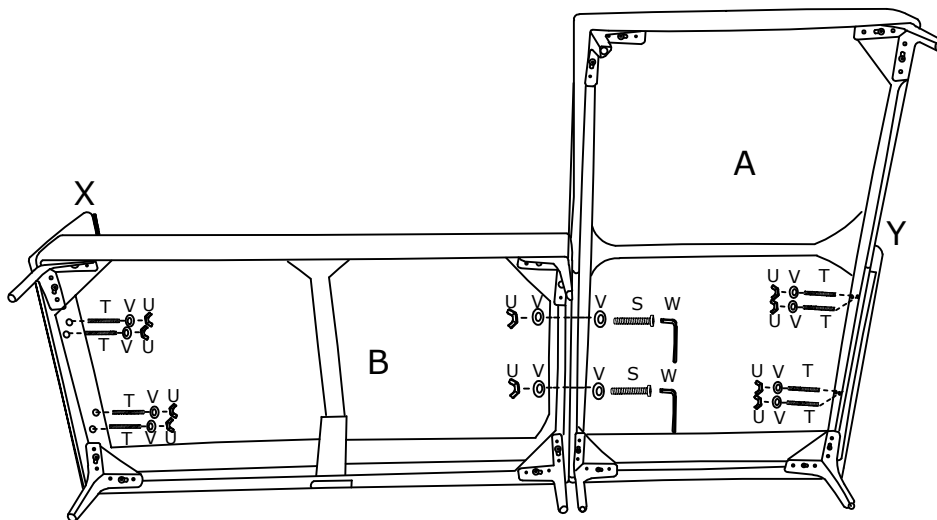

Assemble the handrail (X) (Y) with screw (T) gasket (V) butterfly nut (U), and then assemble the seat frame with screw (S) gasket (V) butterfly nut (U)

S	 M8X80mm	2PCS
T		8PCS
U		6PCS



STEP 3

Assemble the back frame (N) (O) with spacers (v) and screws (R).

R	 M8X60	12PCS
U		12PCS

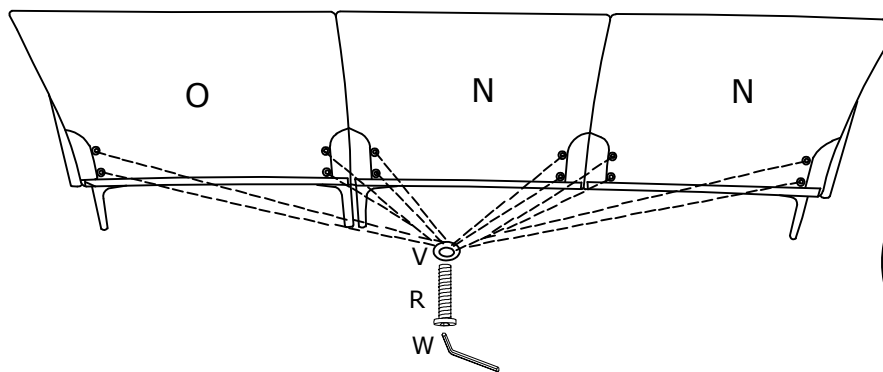

STEP 4

Put the condom on the back frame.

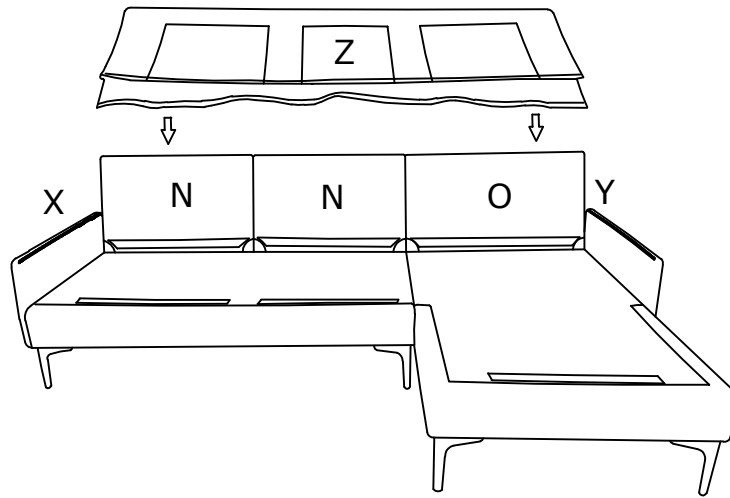

STEP 5

The cushion is packaged by vacuum compression .After cutting the package,it rebounds quickly within 10s.If the fabric has wrinkles,it will basically disappear after standing for 72 hours.

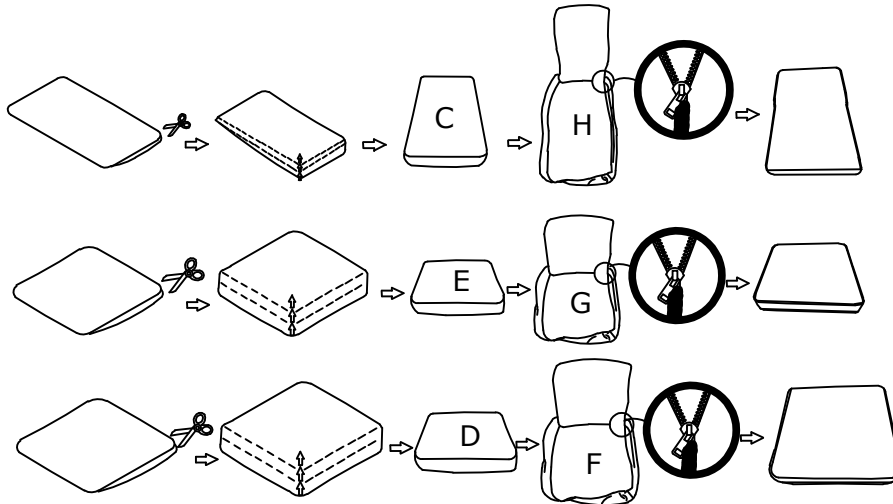

STEP 6

First put the seat cushion on the sofa, and then zip up the armrest bag.

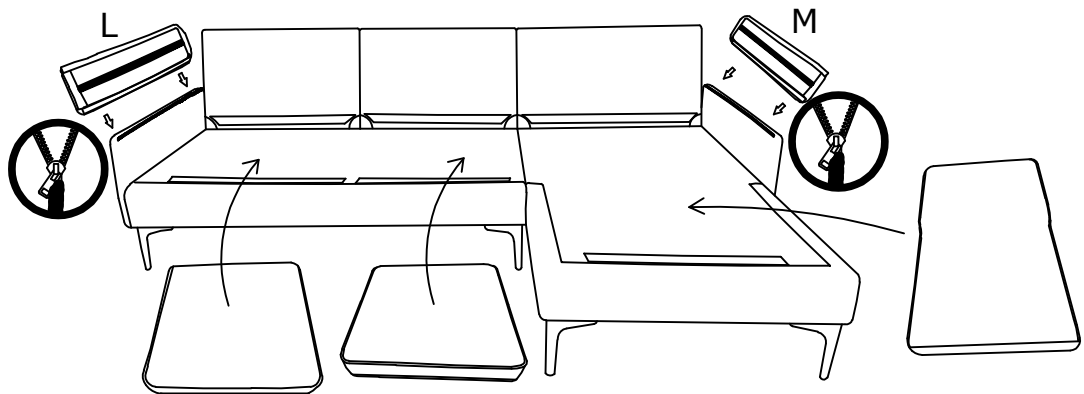

STEP 7

Put the backpack on the sofa

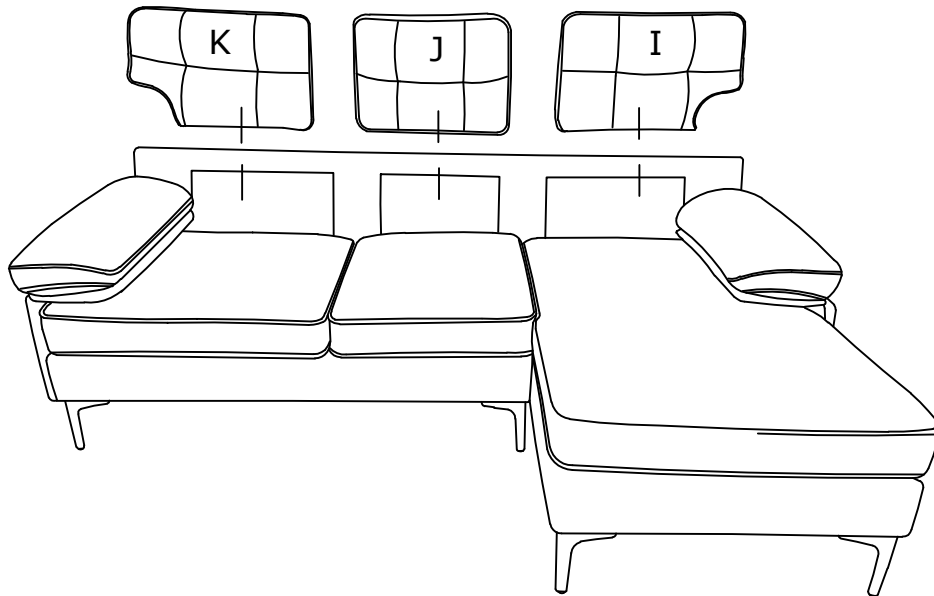

STEP 8

If the fabric has wrinkles, placing 72 horus will basically disappear. Well done! ! You can now enjoy your leisure time on the sofa

