

PLEASE DO NOT RETURN TO STORE

User Manual
ASSEMBLY INSTRUCTION
TV40180



Please do not return this product to the retailer!
We are able to assist you in ANY way!



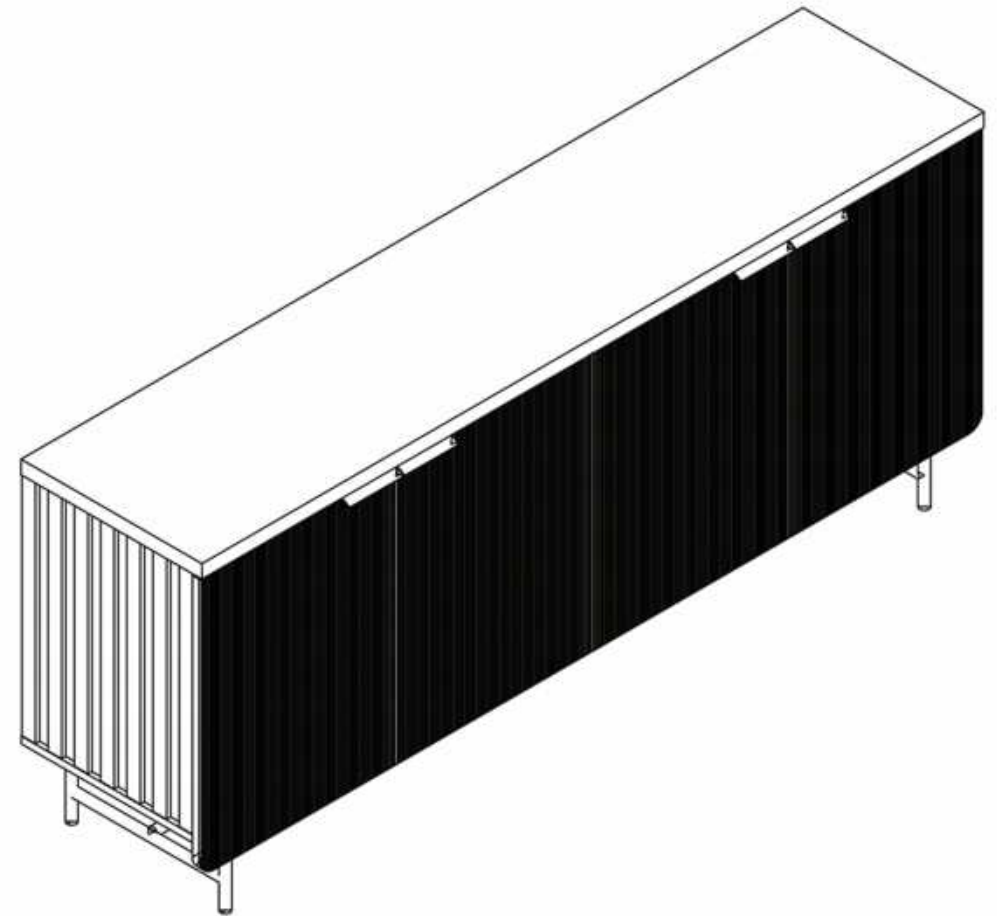



If you find that you have any trouble with assembly or
missing or damaged parts please contact the seller.











QR code for product installation video



Hardware Fitting

NO.	Drawing	QTY
A		20
B		20
C	 6*30mm	12
D		16
E	 L399mm	2
F	 L418mm	2
G		32

NO.	Drawing	QTY
H	 3.0*14mm	32
I		4
J		4
K	 3.5*14mm	60
L		1
M		20
N	 3.5*35mm 3.5*14mm	2
O	 L120mm	4



Parts List

NO.	Drawing	Dimension	QTY
1		1730*400*30mm	1
2		1730*378*15mm	1
3		500*378*24mm	1
4		500*378*24mm	1
5		500*378*15mm	1
6		500*378*15mm	2
7		570*431*18mm	1
8		570*431*18mm	1
9		570*431*18mm	1

NO.	Drawing	Dimension	QTY
10		570*431*18mm	1
11		398*362*15mm	2
12		416*362*15mm	2
13		409*255*4mm	2
14		409*255*4mm	2
15		428*255*4mm	2
16		428*255*4mm	2
17		360*185*20mm	2
18		1526*185*20mm	1

-2-

-15-

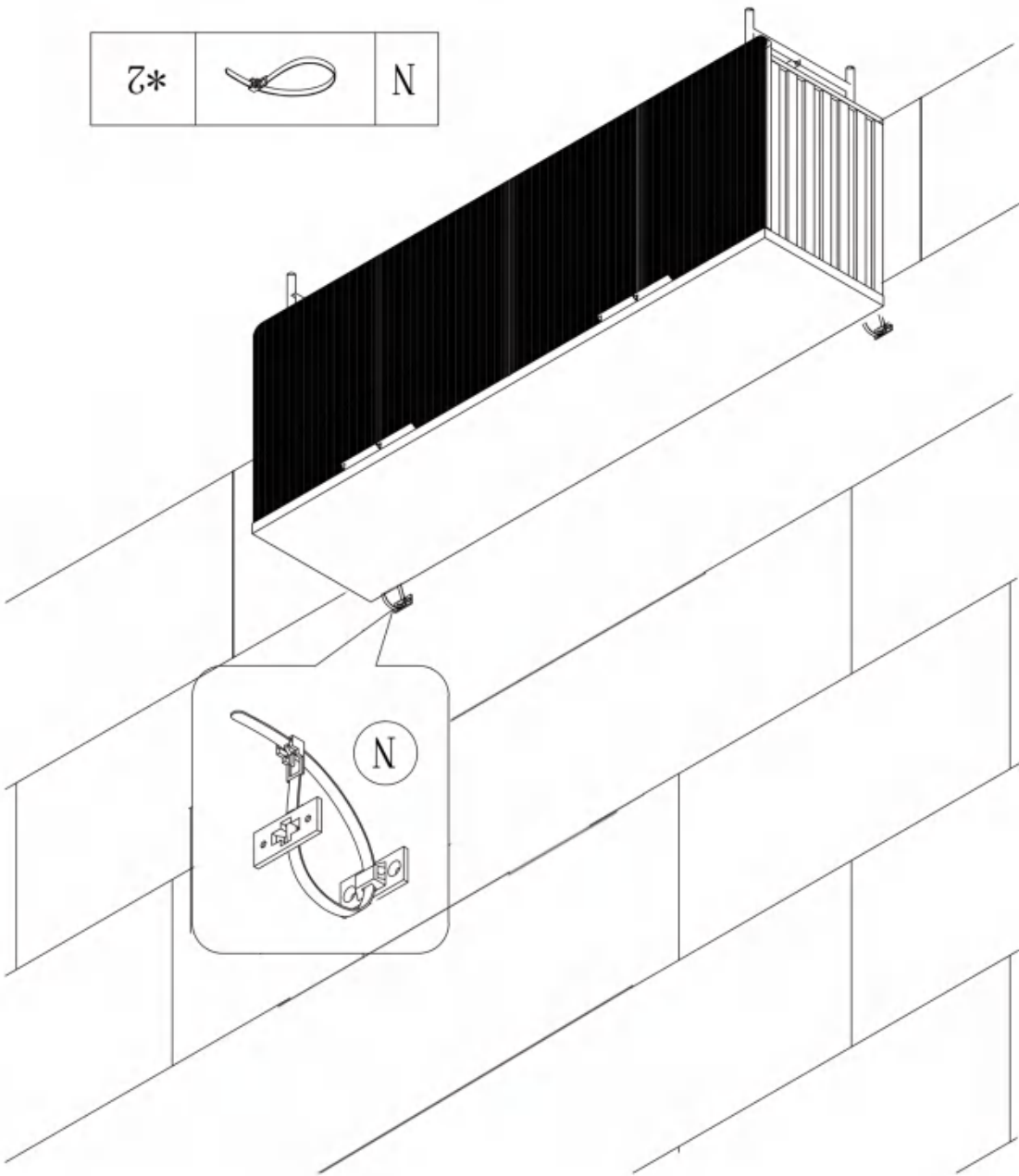

N		*2
---	--	----

Cam Coupling Using Methods

Step1. Connect the cam coupling A as directed in the assembly instructions using hand.

Step2. Screw the cam coupling A as directed in the assembly instructions.

Step3. Push the cam coupling A into the entry hole.

Step4. Insert the cam coupling B as shown in the instructions.

Step5. Turn the cam coupling B clockwise with a screwdriver

Step6. Put on Beautycam.

Step7. Finished.

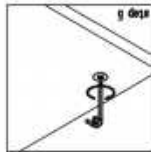
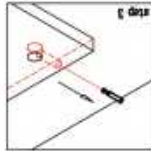
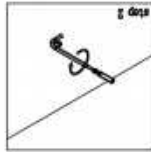
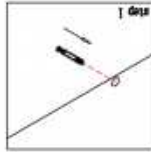

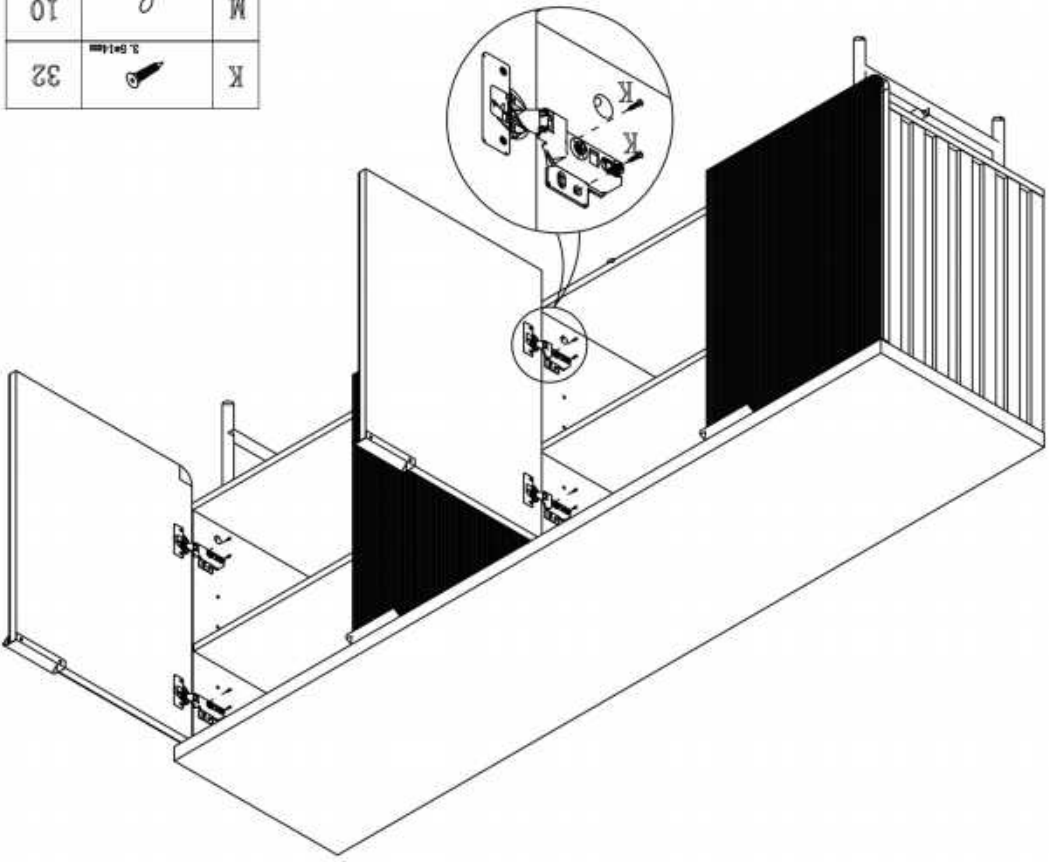

You should feel a click when the camlock is locked in place. The joint is now secure.

M	0	10
K	32	32

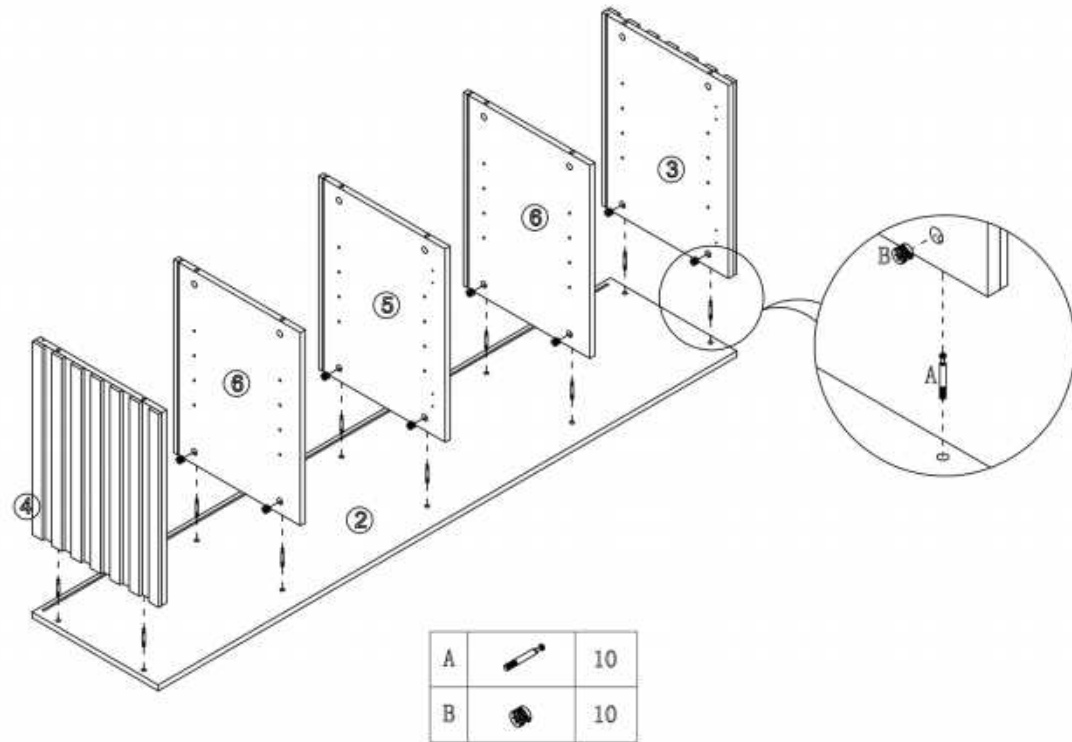
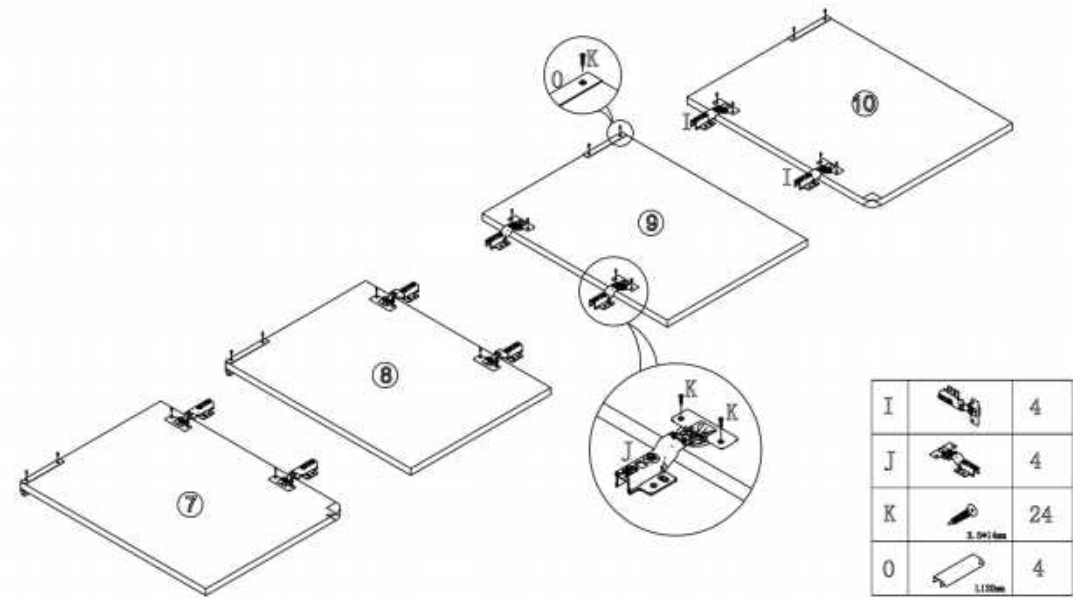

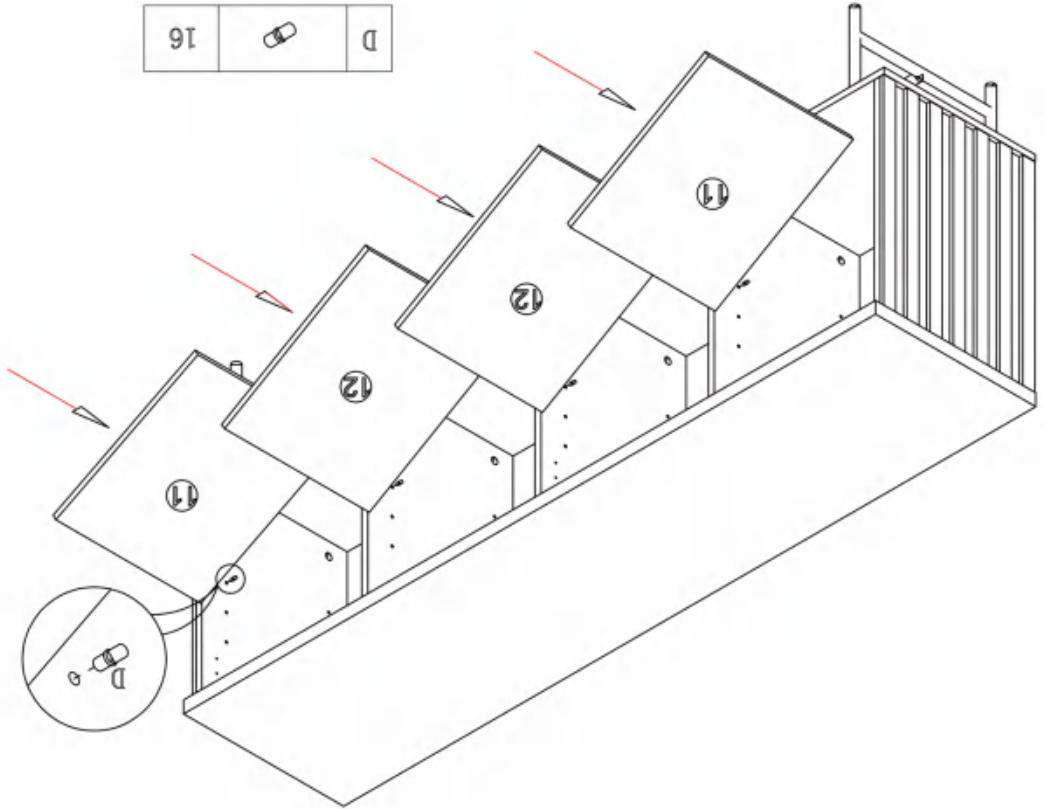



1		141mm	H
1		139mm	H

