

Assembly Instructions

Caution: You must read this before you proceed

Hammock on Wooden Stand

The Hammock on a Stand is used in conjunction with a Canopy

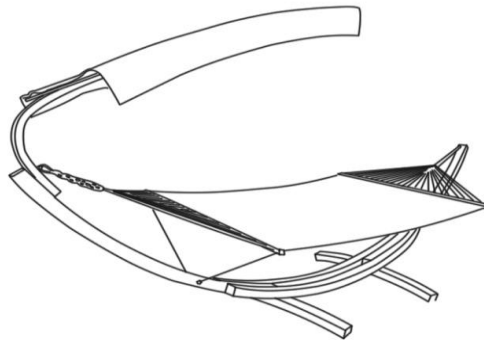









CAUTION : Do Not Swing on or in hammock. This could cause the product to tip over resulting in possible injury. This Hammock on Wooden Stand is NOT a TOY.

Keep your child / children at bay during the assembly process. Have at least three adults on hand to help with assembling this Hammock.

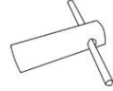
Parts List

Label	Picture	Description	QTY
A		Supporting Bar to hold Hammock	2
B		Mid-Joint Support Bar	2
C		Ground Bar	2
M		Hammock with Wooden Support Rail	1
O		Rope with Carabiners (To connect bed and Supporting Bar A).	4
S		Canopy (Separate Carton)	1

Hardware

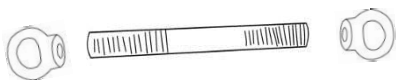
Label	Picture	Description	QTY
D		Bolt(M10X14CM)	5
E		Washer	23
F		Nut	11
L		Socket Wrench	2
H		Bolt(M10X24CM)	5
J		Metal Chain with Iron Carabiners (Connect bed rail to rail of Supporting Bar A)	2
K		Eye Bolt	2
Q		Bolt and Ring Nut	4
R		Allen Key	1
N		Bolt and Ring Nut	2

Assembly Preparation

Before Beginning Assembly:

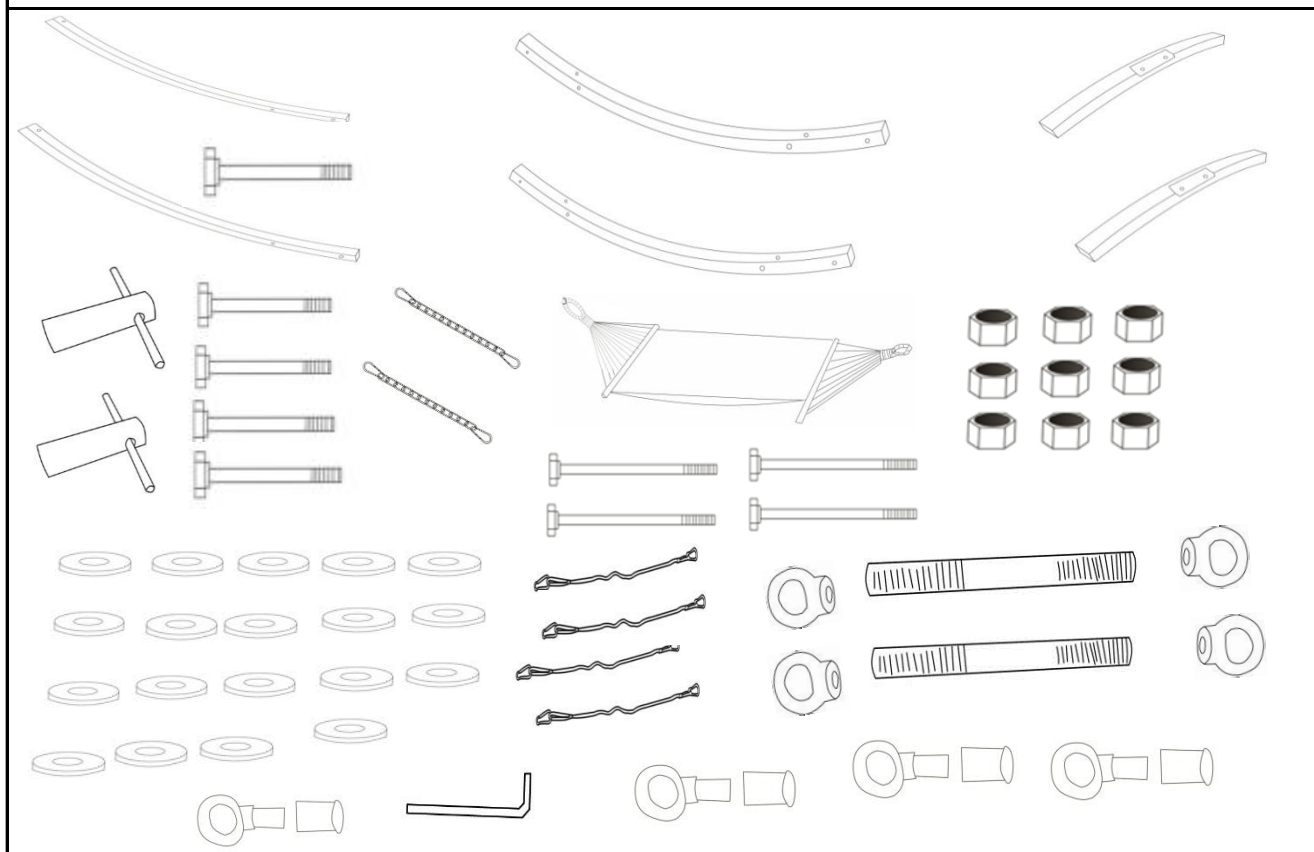



- Read instructions, cover to cover-



- Have 2 adults on hand for assembly-



- Do not assemble on flooring or carpet-



- Assemble on a clean non-marring surface (packing foam)-



- Save all packaging until finished-

Assembly Steps

Step 1

Note : The **COUNTERSINK** hole side of Wooden Bar(B) should be on the **outside**.

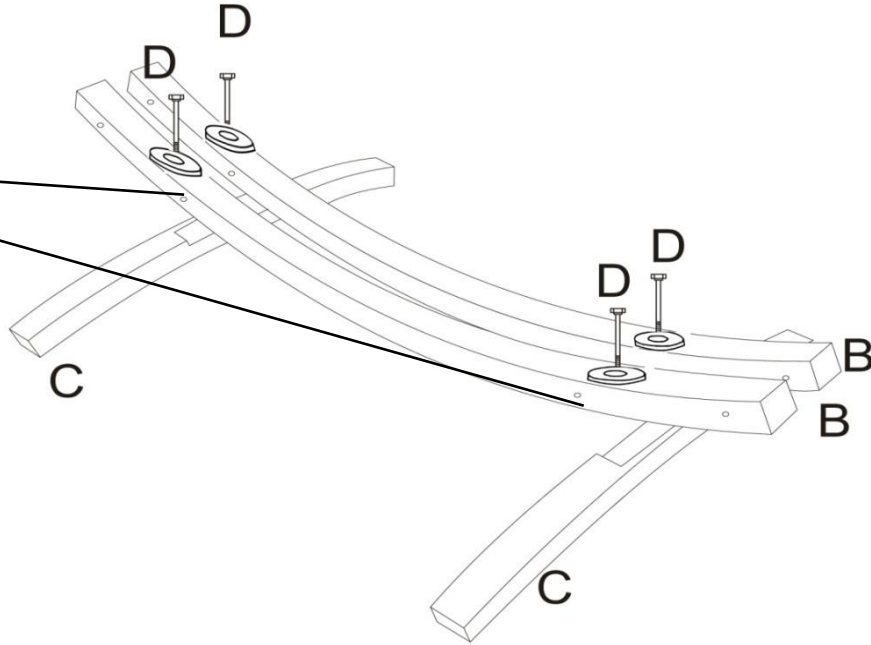

Attach Mid-Joint Support Bar(B) to Ground Bar(C) using Bolt(D) and Washer(E), as shown in the picture.

In this step, **DO NOT** tighten the bolts.

Step 2

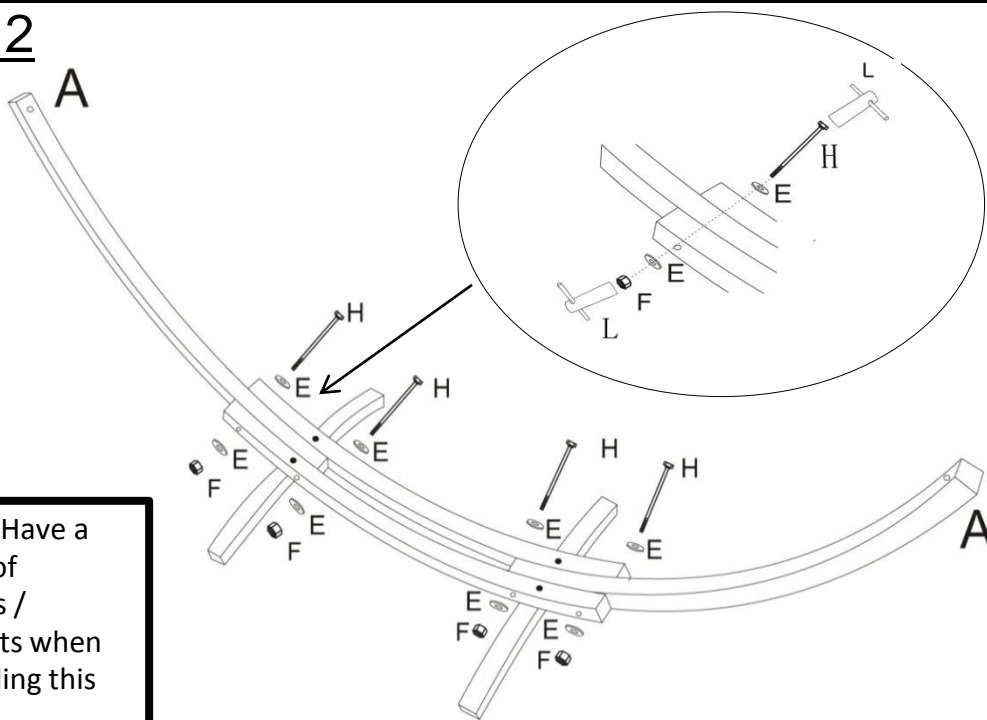

NOTE : Have a couple of partners / assistants when assembling this

Put Supporting Bar to hold Hammock(A) into Mid-Joint Supporting Bar(B). Then attach using Bolt(H) and Hardware(E,F) with Socket Wrench(L).

Tighten the bolts of this step securely.

Step 3

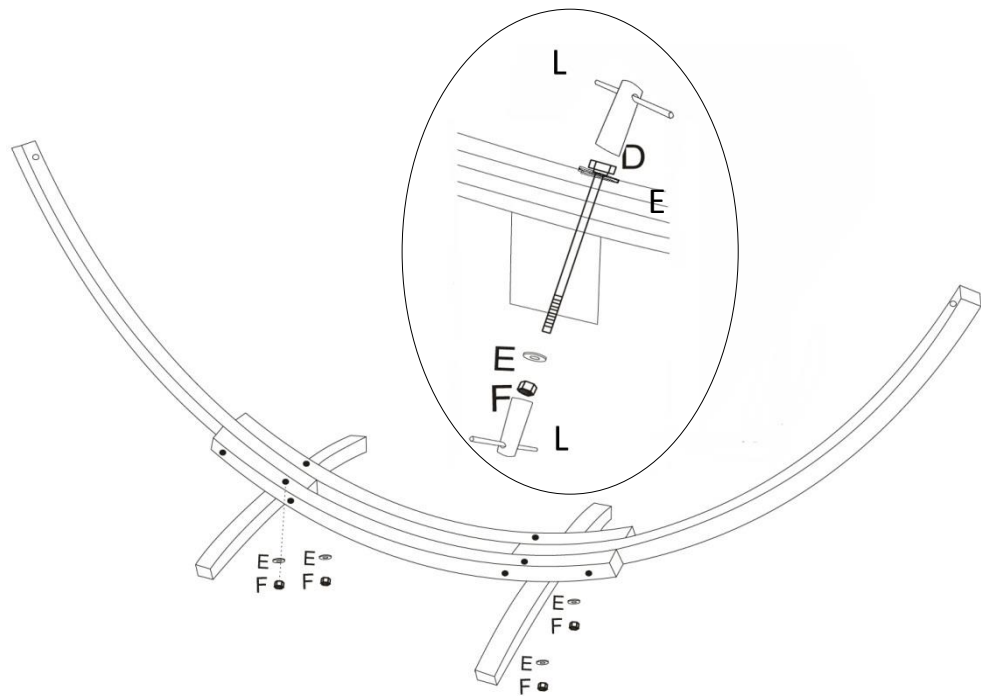

NOTE : This step should be finished with two or more people

Tighten the Bolts(D) from **Step 1** using Hardware(E,F) with Socket Wrench(L).
Tighten the bolts securely.

Step 4

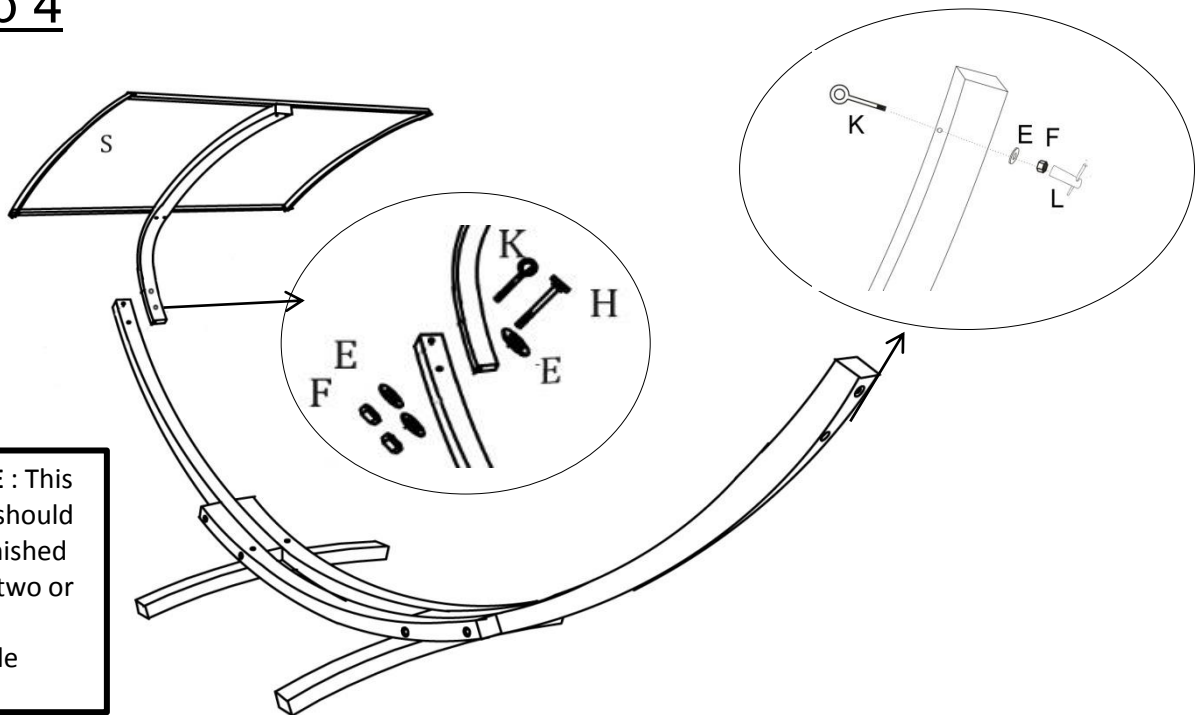

NOTE : This step should be finished with two or more people

Connect the Canopy(S) to the Supporting Bar to hold Hammock(A) using Hardware (E,F,H) and Eye Bolt(K). Attach the Eye Bolt(K) to the **tail end** of the Supporting Bar to hold Hammock(A) using Hardware(E,F) with Socket Wrench(L).

Tighten the bolts of this step securely.

Note: The Eye Bolts should be facing the inside of the frame assembly.

Step 5

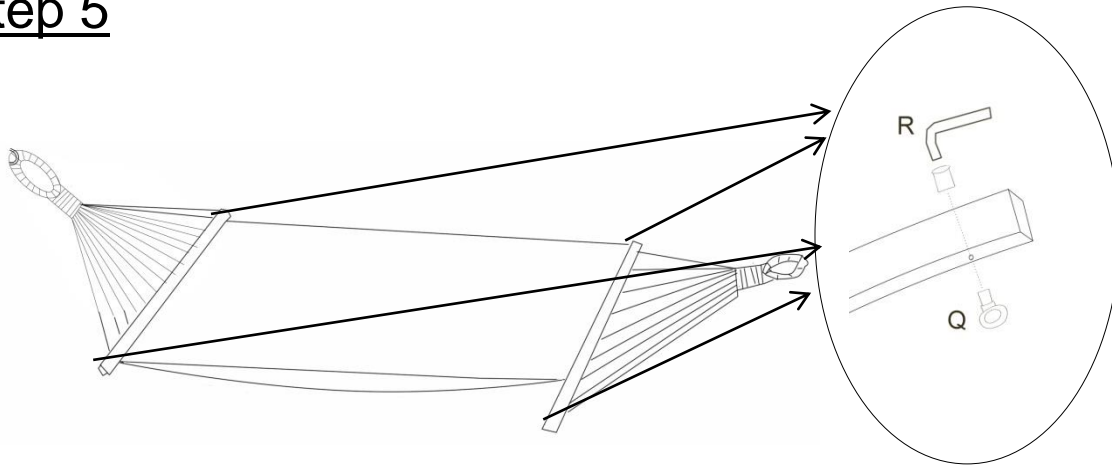

Screw the Bolt and Ring Nut(Q) to the four ends of the Wooden Support Rails with Allen Key(R)

Tighten the bolts of this step securely.

Step 6

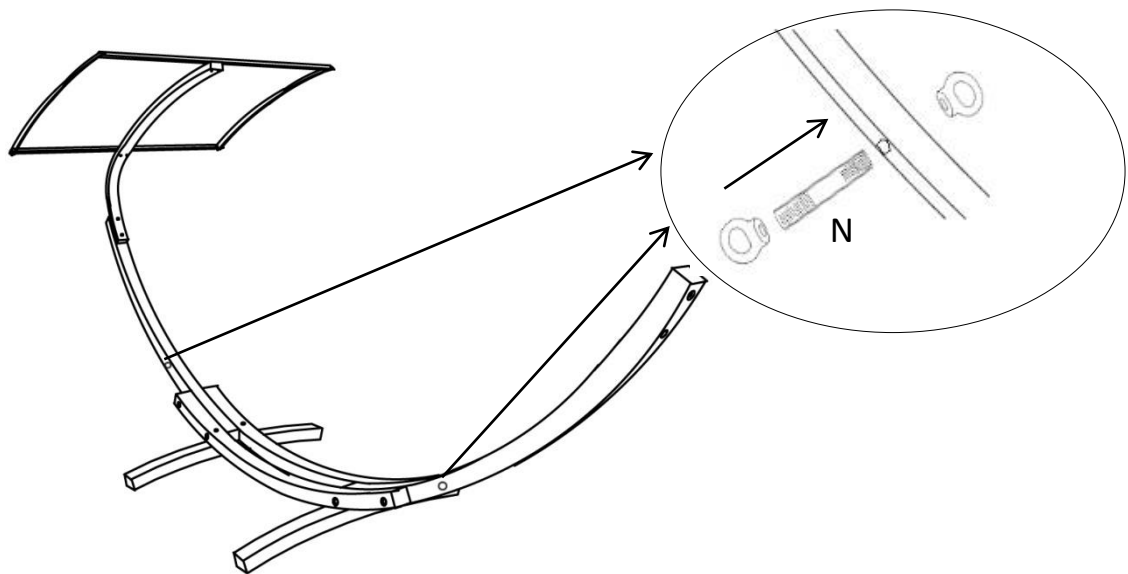

Insert the Bolt and Ring Nut (N) into the Supporting Bar to hold Hammock(A), as shown in the picture.

Tighten the bolts of this step completely.

Step 7

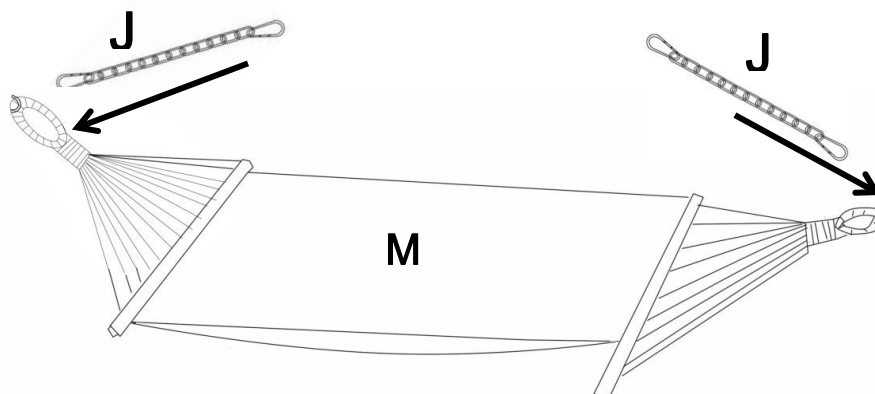

Hook the Chain with Carabiners(J) to the two loop holes at each end of the Hammock with Wooden Support Bars(M).

Step 8

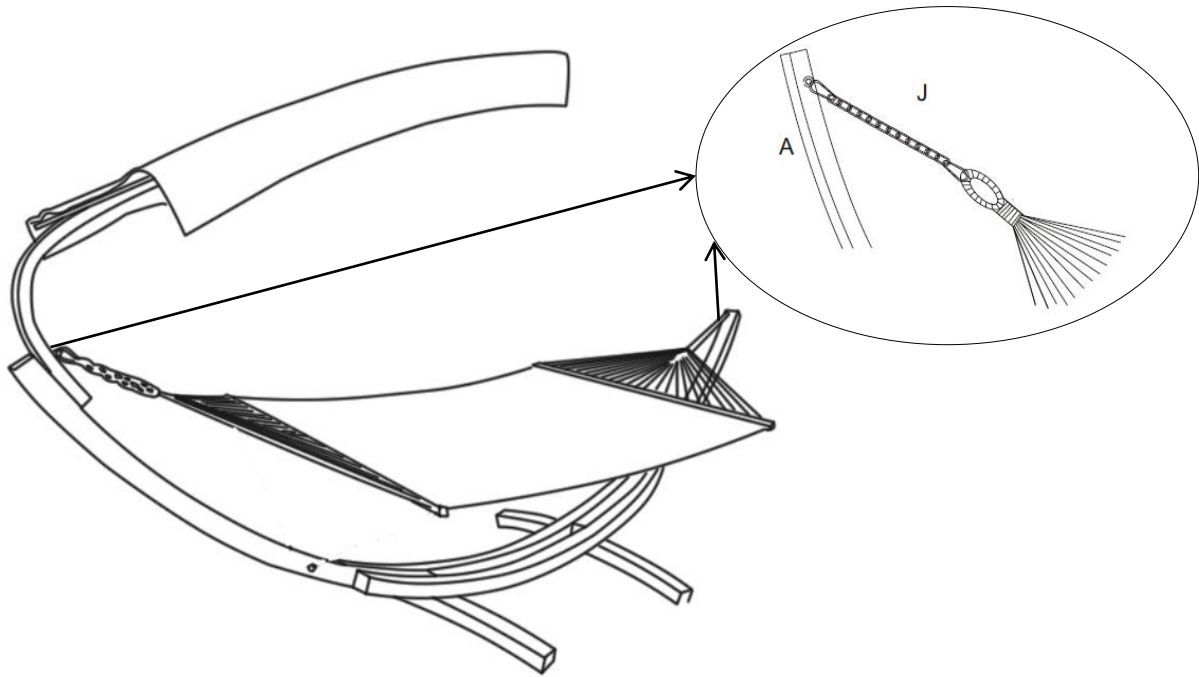

Connect the Hammock(M) to the Supporting Bar to hold Hammock(A) using Chain with Carabiners(J).

Step 9

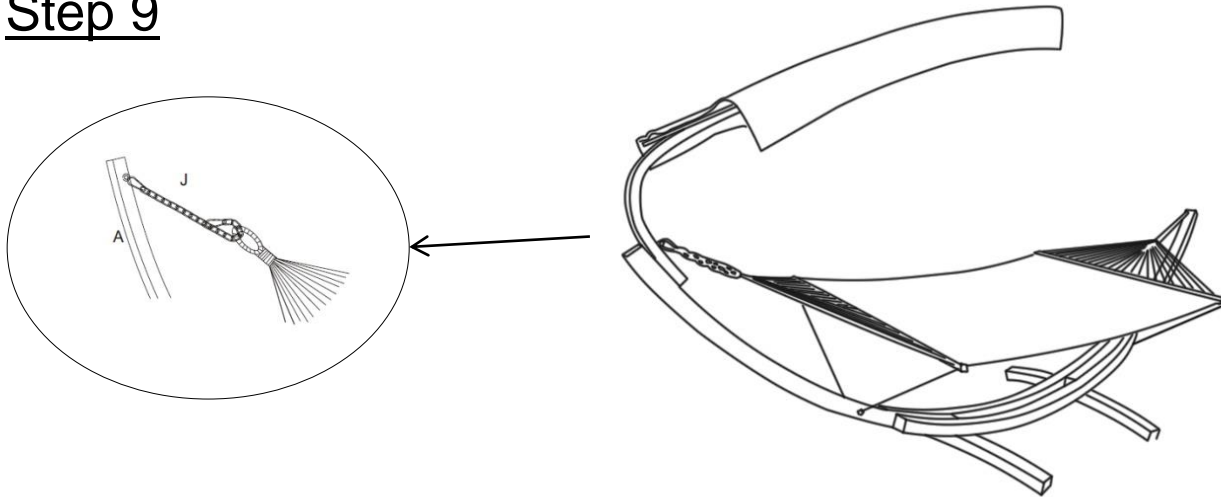

Connect the four Eye Bolts(K) on the Hammock(M) to the Bolt and Ring Nut(N) on the Supporting Bar to hold Hammock(A) using Rope with Carabiner(O).



Adjust the Chain with Carabiners(J) until the four Ropes are taut.

Your Hammock is ready for use.

Caution: Always be careful of your safety when getting on and off of the Hammock, children should not be allowed on the Hammock without adult supervision.

Care & Maintenance

-   Do not put hot items directly on furniture surface.
-   Do not clean furniture with harsh cleansers or polish.
-   To obtain the longest lifespan of your outdoor products, minimizing exposure to direct sunlight is recommended.
-   Children should not climb or jump on the furniture.
-   Do not write on furniture without a padded barrier to protect the surface.
-   To obtain the longest lifespan of your outdoor products, avoid extended and lengthy exposure to rain, snow, and direct sunshine. Whenever possible cover the product and /or place under patio or awnings.
-   Not for commercial use. For residential use only.
-   Stains may be removed with mild soap solution and damp cloth.

-
-   Dust and pick-up spills using a clean, non-colored, lint-free cloth.

What Is Proposition 65?

Proposition 65 is a California law that requires warning labels on products that may contain one of more than 800-plus chemicals or ingredients that the California Office of Environmental Health Hazard Assessment (OEHHA) has deemed to cause cancer or other reproductive toxicity. Chemicals and elements on this list include wood dust, brass, and other everyday substances, which can be found in very common household items, such as: lamps, tableware, jewelry, crystal glasses, electric cords, beauty products, automobiles, and furniture.

Why Did I Find a Proposition 65 Warning on My Home Goods Product?

We include Proposition 65 warnings on all of our products because there is always a chance that one of the 800-plus common chemicals and ingredients listed under this law could potentially be on our furniture or packing materials. We risk large fines under this law, if we don't include this warning.

Should I worry?

We realize you may be worried finding this warning on our products, but we want to reassure you that the hazardous exposure limits for any of these chemicals have never been found on furniture products that we've shipped to our customers. Additionally, this warning label is very common and can be found on almost every piece of furniture sold in the state of California.

Just How Common Are Proposition 65 Warnings?

Proposition 65 warnings have become so common in California that it is hard to take a trip to a local bank, grocery store, or restaurant without finding at least one warning. In fact, even the Disney Land Resort has a Proposition 65 warning:

