

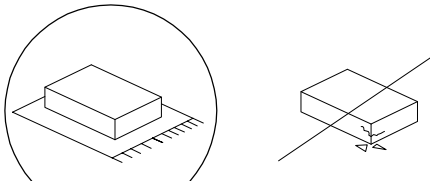

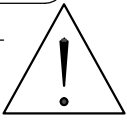



		15'
		
		1

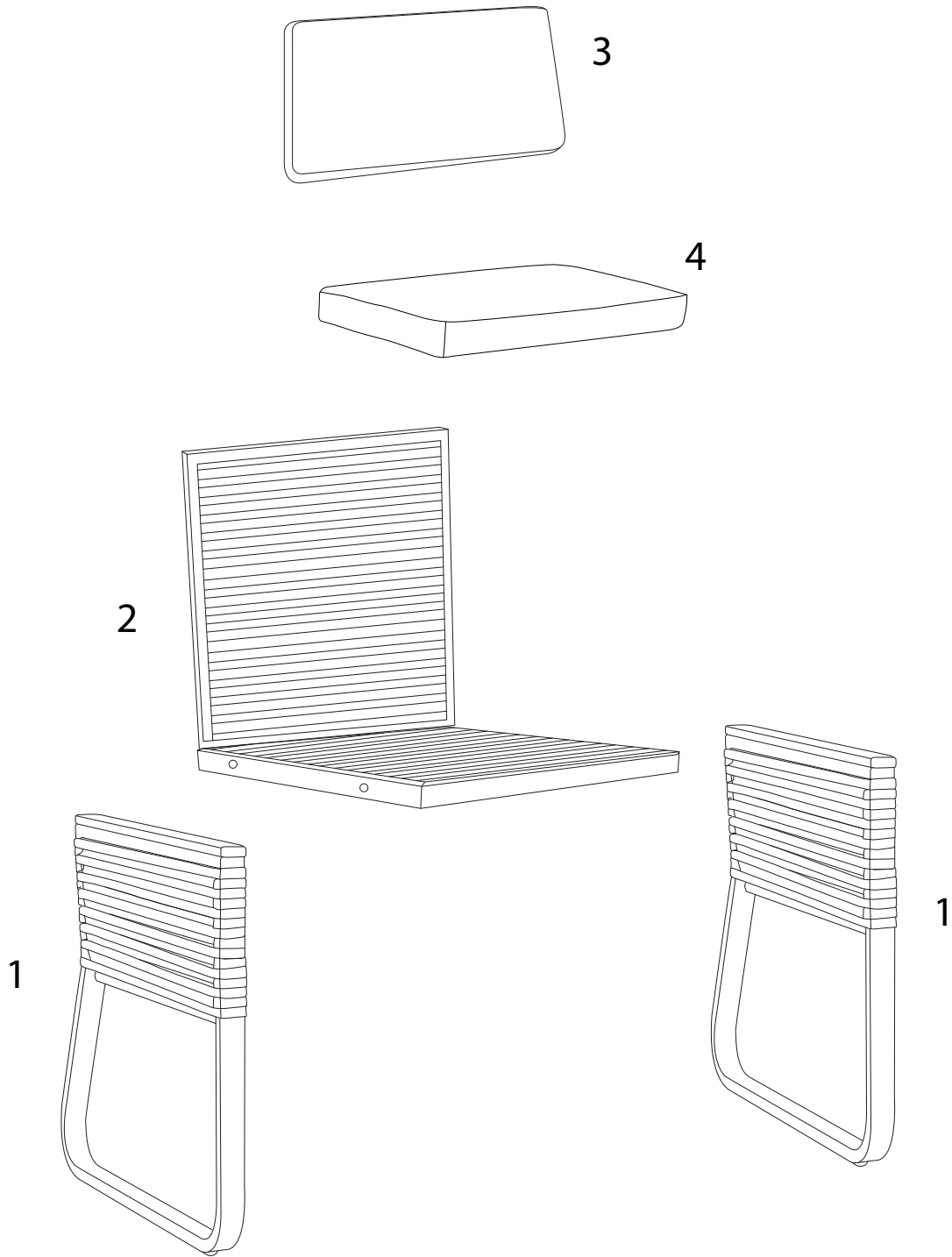

1	2	3	4
			
x 2	x 1	x 1	x 1

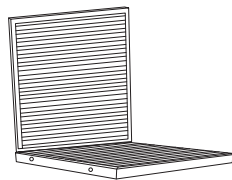
A

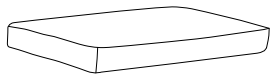
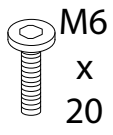

x 2

B

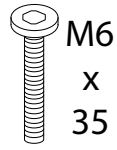

x 4

C

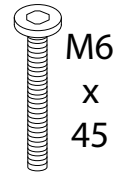

x 2

D

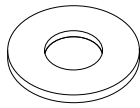

x 8

E

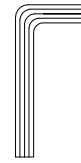

x 1

1

1



x 2

2



x 1

B



x 4

D



x 4

E

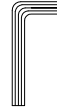

x 1

2

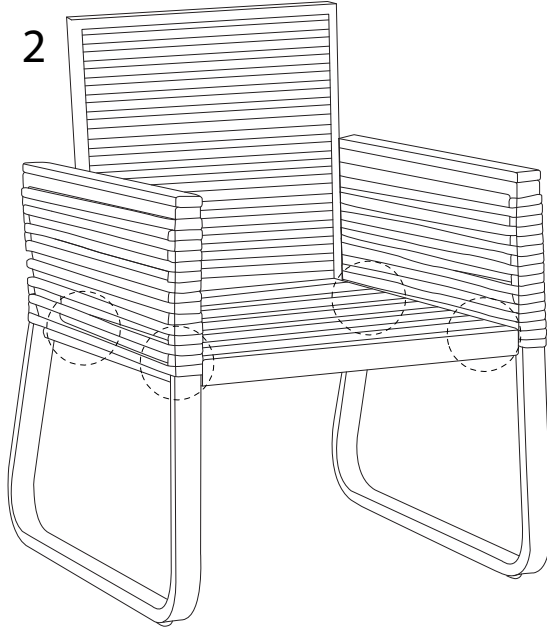

1

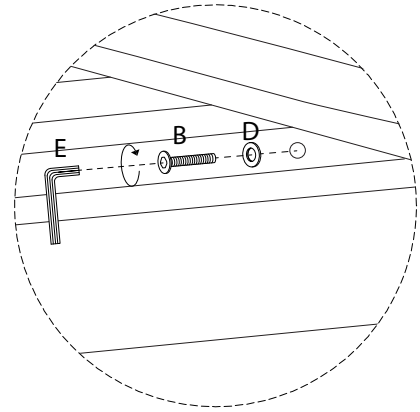

2

A



x 2

D



x 2

E

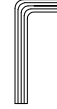

x 1

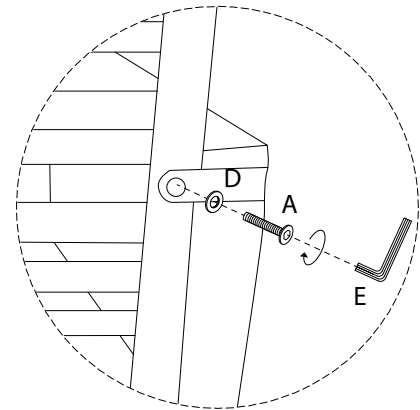
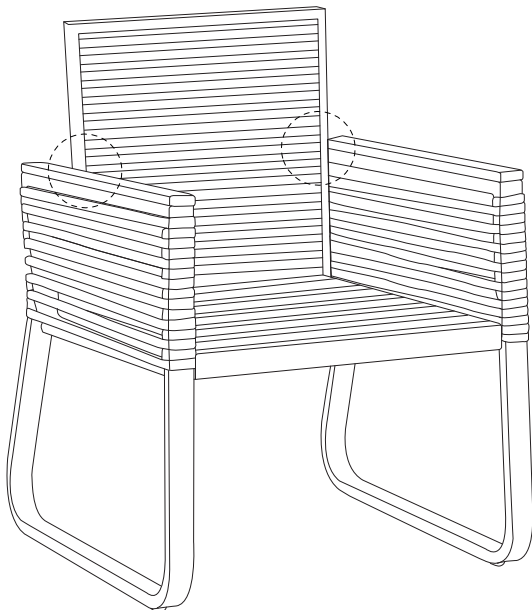

3

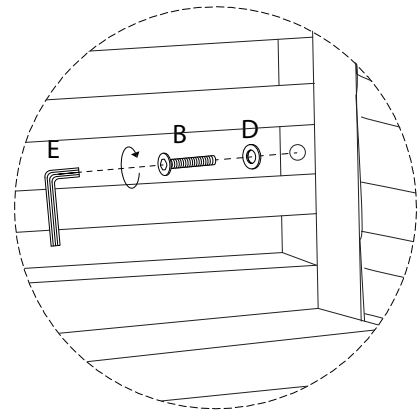
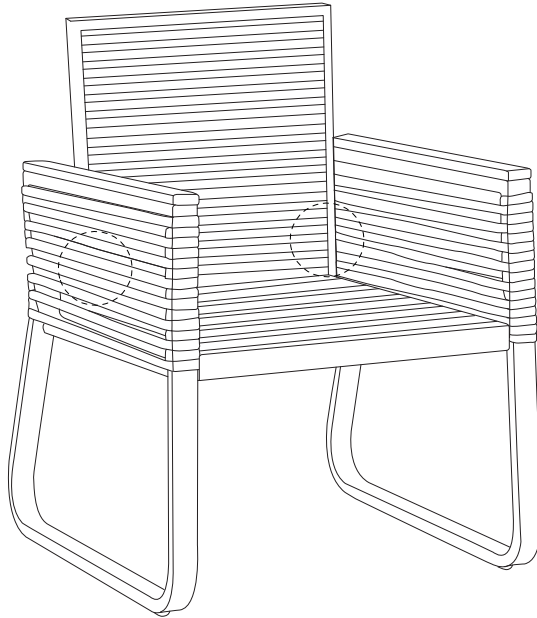
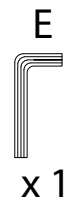
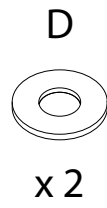
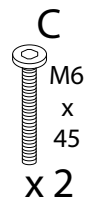

4

