

ASSEMBLY INSTRUCTION

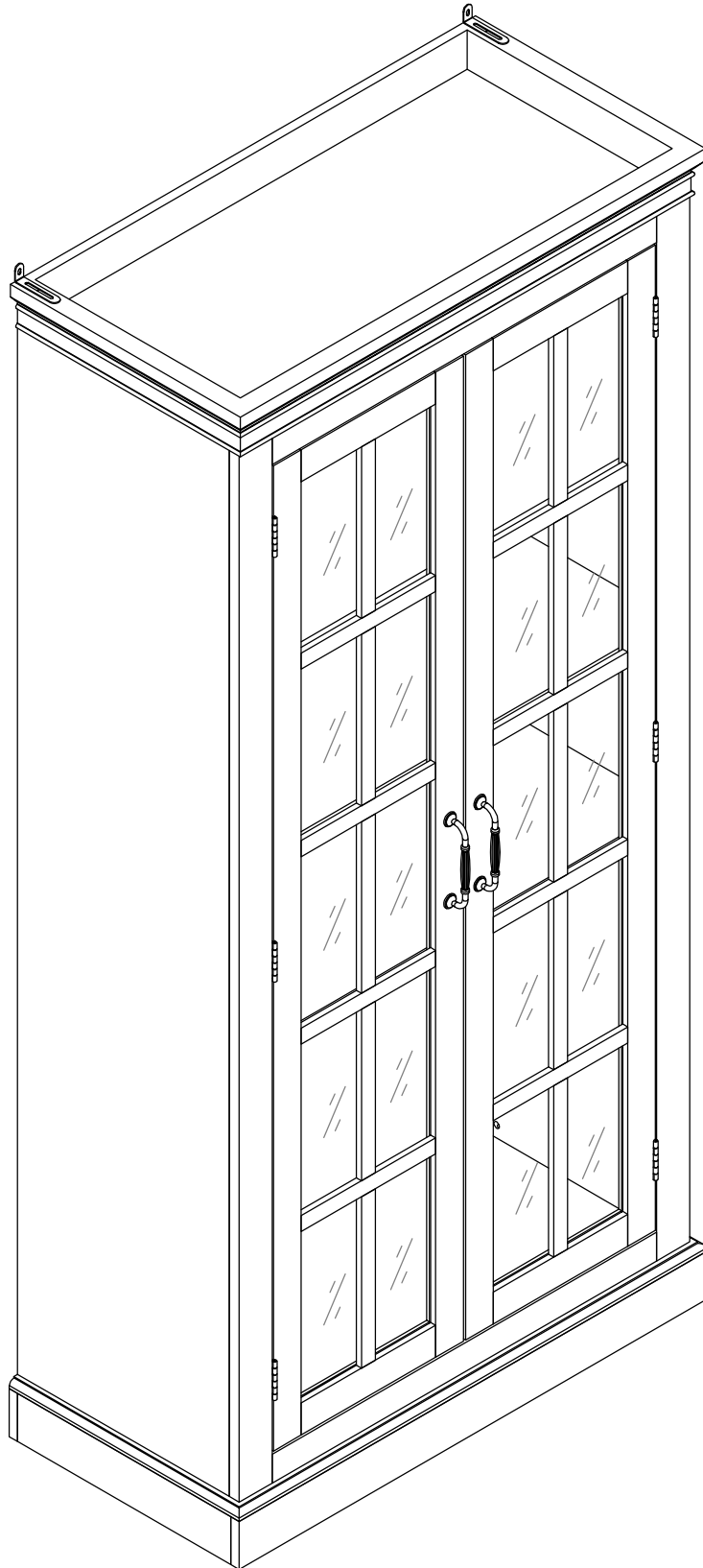

1. Thank you for choosing ***our products.***

2. Return Policy







DO NOT RETURN TO THE STORE! Skip the process of returning your product and contact us directly for a replacement

If you find that parts of your order are missing or damaged, we will gladly ship any needed replacement parts free of charge.

If your product's quality does not meet your expectations or you have found any sort of defect, please contact our customer service department and let us know the details of your order and any issues encountered, we will try our best to provide you with a solution. Feel free to also directly contact our manufacturer concerning needed replacement parts and they will be happy to help provide you with a solution or answer any questions you may have.

Recommendations Before Beginning Assembly

-  • Read instructions, cover to cover
-  • Have 2-4 adults on hand for assembly depending on product size
-  • Do not assemble directly on flooring or carpet
-  • Assemble on a clean non-marring surface (example: packing foam)
-  • Save all packaging until finished

3. Assembly Notice:

- If you encounter any problems during assembly and find that you cannot continue, rest assured we will help you solve the situation as soon as possible. Simply keep all of the parts of the product stored in a safe place and contact us immediately so we may assist you further.
- Once you have opened your package, remove all inner hardware packages and take the parts out. One by one, Place the parts out neatly in front of you, then refer to the instructions to ensure no parts are missing. If any pieces are found missing, please carefully look in the box first, as the hardware packaging might have torn making the hardware spill in the box.
- Some key parts of your product may be stored and hidden inside of other parts. Please open any zippered or hook & loop storage compartments to remove all parts. (example: cushions and legs being stored in the underside of a sofa)
- **IMPORTANT:** When setting up your product, **DO NOT INSTALL THE SCREWS ALL THE WAY IN THE BEGINNING.** Place each screw into their proper hole and use your hand to twist the screw halfway. Twist all the screws in halfway to ensure the holes will match up properly and the product is level on the ground. When everything seems fitted, then tighten the screws.

- When you have completed assembly, we suggest you have more than one person to assist you with lifting and placing the product.

Care & Maintenance

- 🚫 🔥 • Do not put hot items directly on furniture surface
- 🚫 🧴 • Do not clean furniture with harsh cleansers or polish
- 🚫 ☀️ • Do not place furniture under direct sunlight
- 🚫 🏠 • Do not place furniture near heating or cooling vents
- 🚫 ✍️ • Do not write on furniture without a padded barrier to protect the surface
- 🚫 ☁️ • Do not place furniture outside. For indoor use only
- 🚫 🏢 • Not for commercial use. For residential use only
- 🚫 🧼 • Stains may be removed with mild soap solution and damp cloth
- 🚫 🧒 • Children should not climb or jump on the furniture
- ✓ 🧻 • Dust and pick-up spills using a clean, non-colored, lint-free cloth

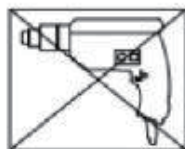

Caution

- This product contains small components. Please ensure that they are kept away from small children.



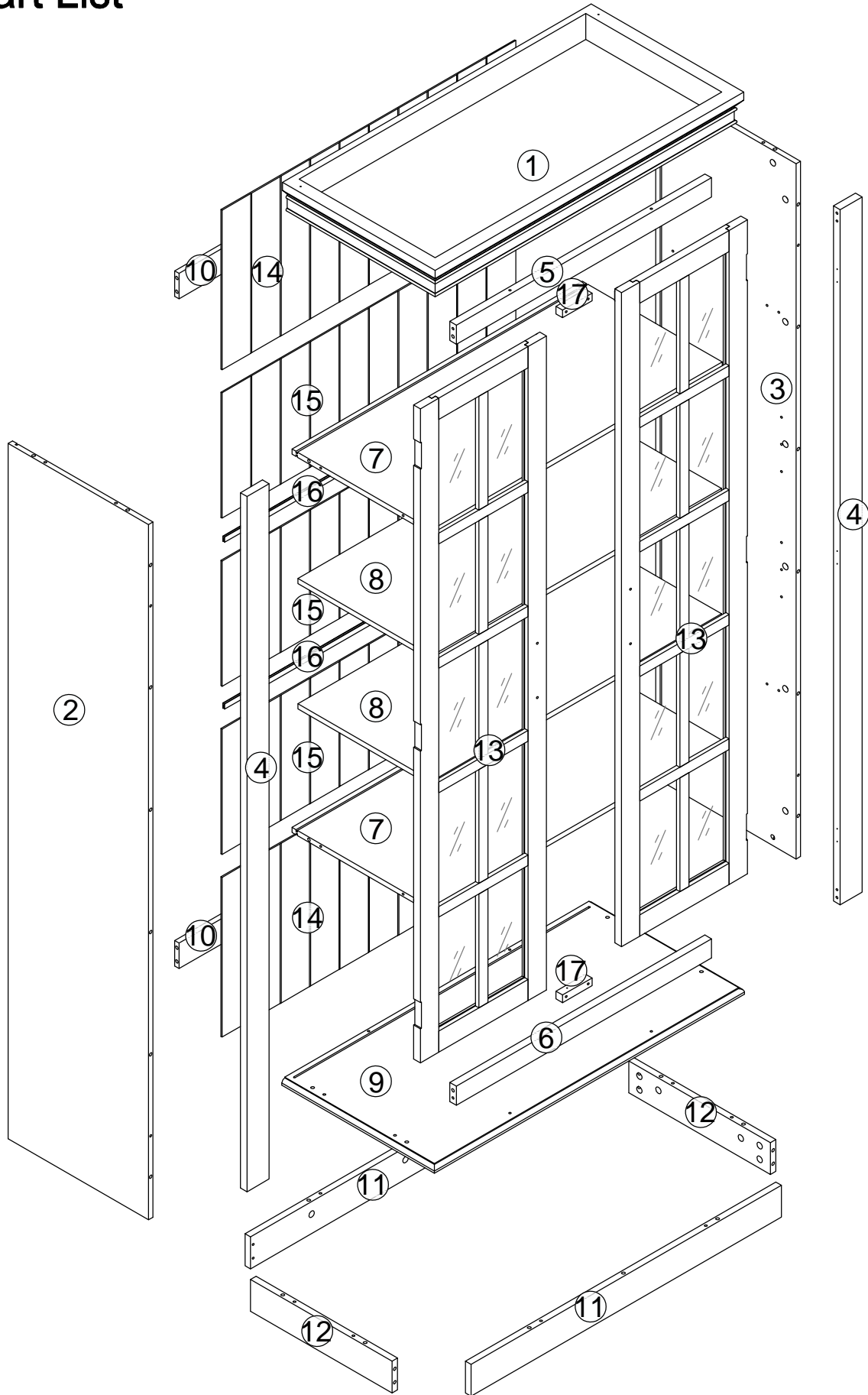

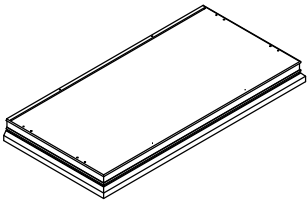
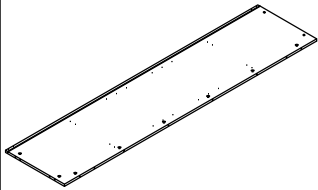
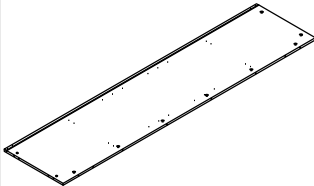
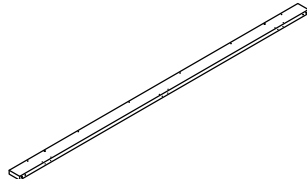
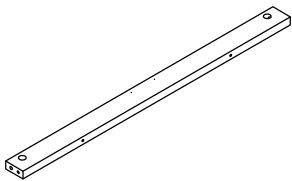
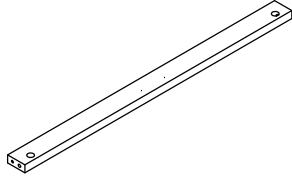
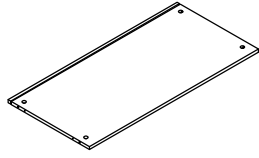
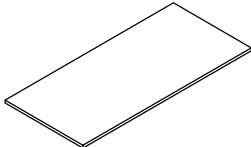
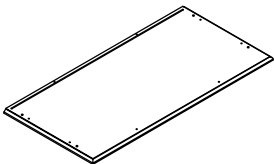
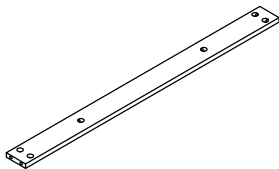
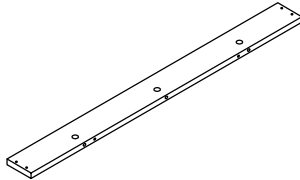
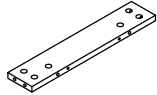
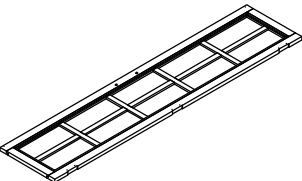
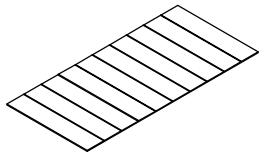
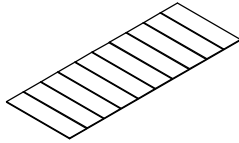

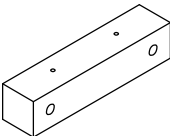

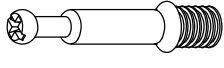

Part List

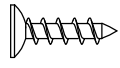
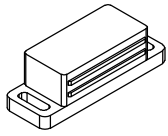
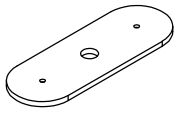
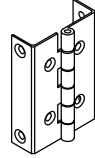
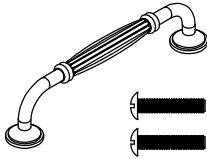
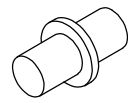
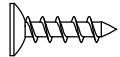
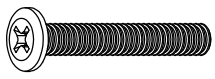

			
① x1pc	② x1pc	③ x1pc	④ x2pcs
			
⑤ x1pc	⑥ x1pc	⑦ x2pcs	⑧ x2pcs
			
⑨ x1pc	⑩ x2pcs	⑪ x2pcs	⑫ x2pcs
			
⑬ x2pcs	⑭ x2pcs	⑮ x3pcs	⑯ x2pcs
			
⑰ x2pcs			

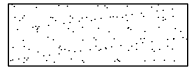
Hardware List

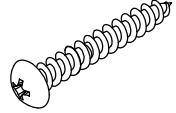
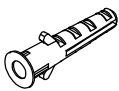
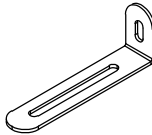
				
Ø6.5X35mm	Ø15X9mm	Ø6X30mm	Ø4X30mm	Ø3X14mm
Ⓐ x58pcs	Ⓑ x58pcs	Ⓒ x32pcs	Ⓓ x6pcs	Ⓔ x24pcs
				
Ⓕ x2pcs	Ⓖ x4pcs	Ⓗ x6pcs	Ⓘ x2pcs	Ⓙ x8pcs
				
Ø3X12mm	Ø6X40mm	Ø10X10mm		
Ⓚ x52pcs	Ⓛ x4pcs	Ⓜ x4pcs	Ⓝ x20pcs	Ⓞ x8pcs
				
Ø4X14mm	Ø4X40mm	Ø8X38mm	65X15X32mm	
Ⓟ x2pcs	Ⓠ x4pcs	Ⓡ x2pcs	Ⓢ x2pcs	

Step 1

x2

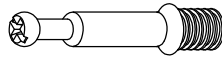

Ø6.5X35mm

(A) x16pcs

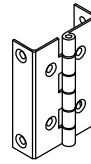

(H) x6pcs

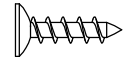

Ø3X12mm

(K) x24pcs

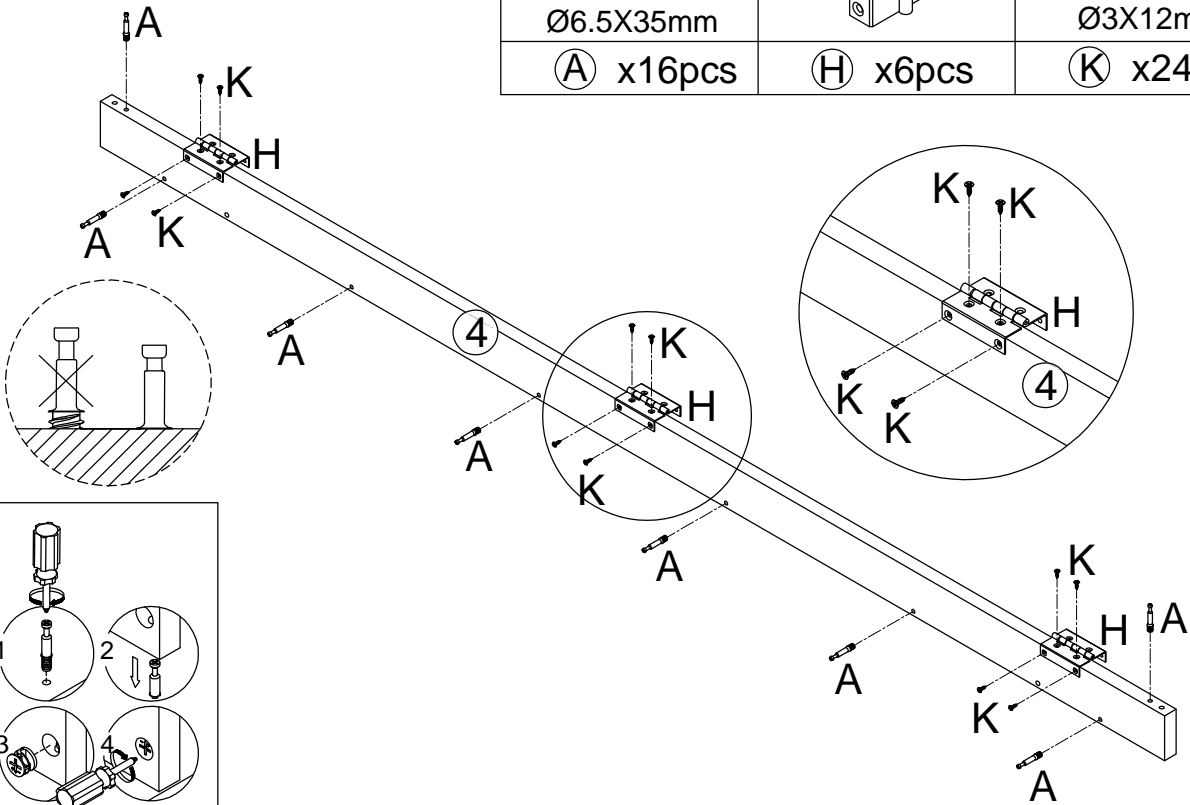

Step 2

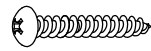

Ø4X30mm

(D) x4pcs

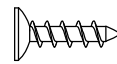

Ø3X14mm

(E) x4pcs

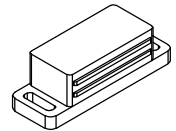

(F) x2pcs

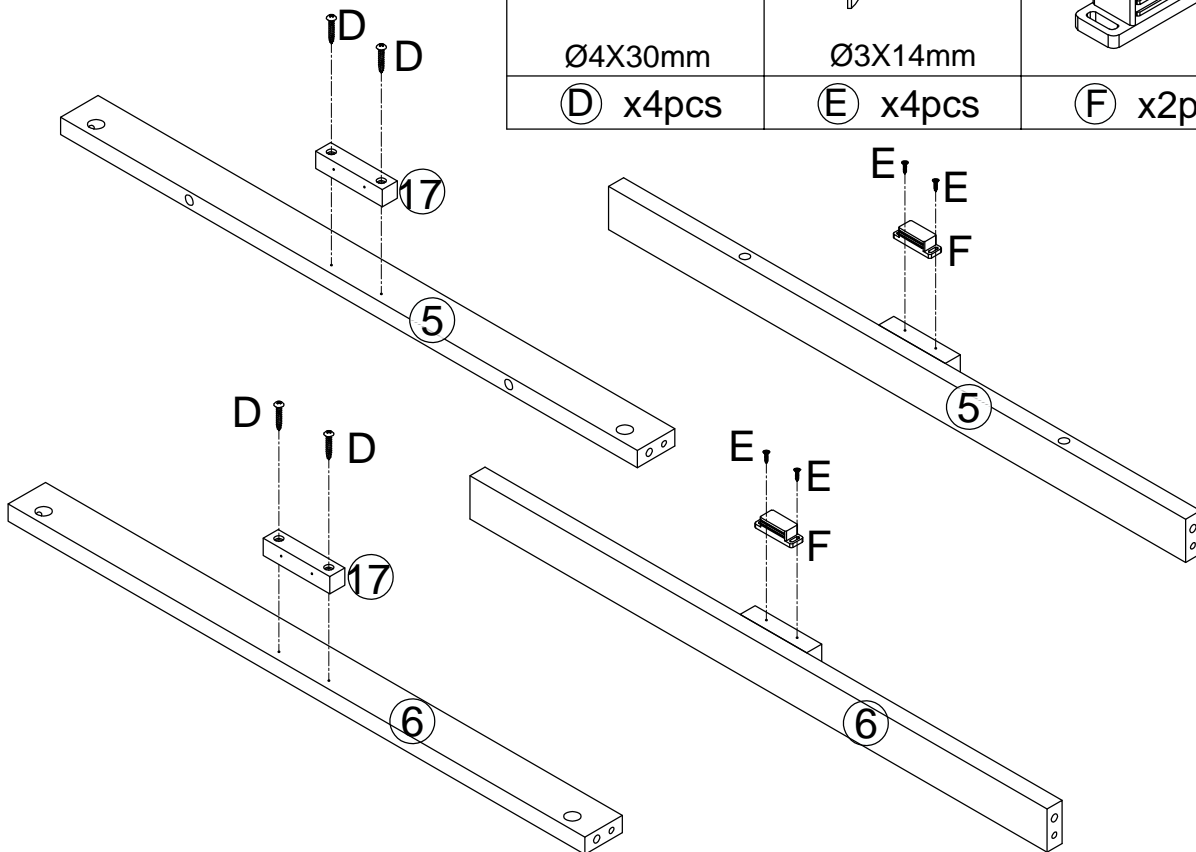

Step 3



Ø15X9mm

Ⓑ x12pcs



Ø6X30mm

Ⓒ x4pcs

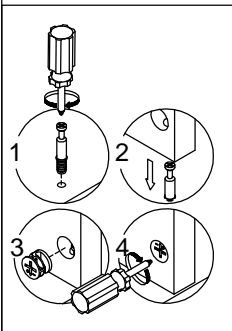
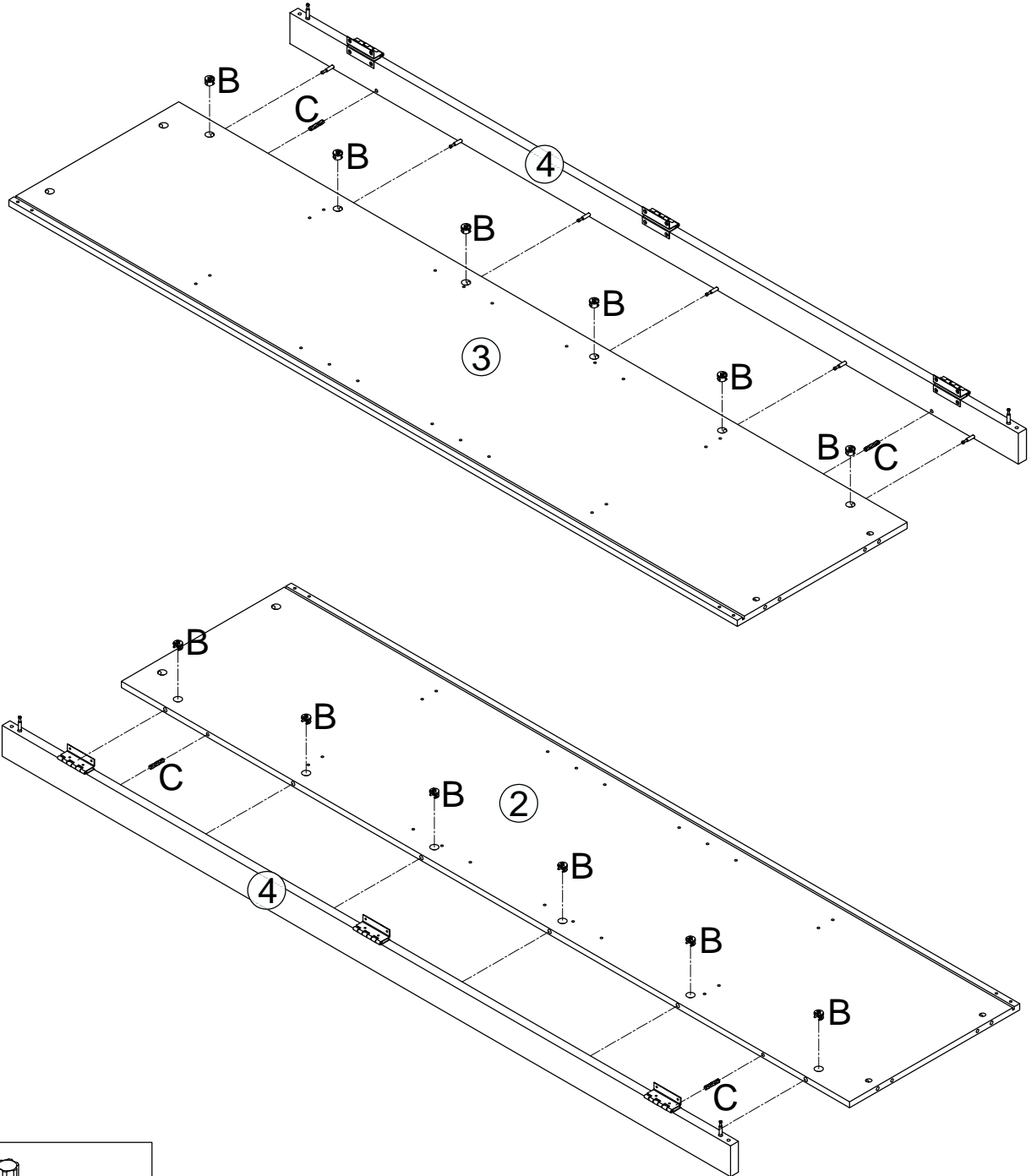

Step 4

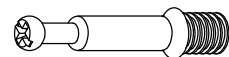

Ø6.5X35mm

(A) x16pcs

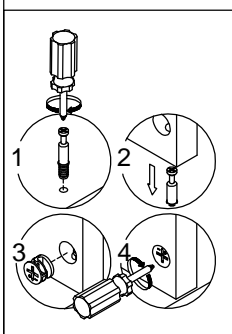
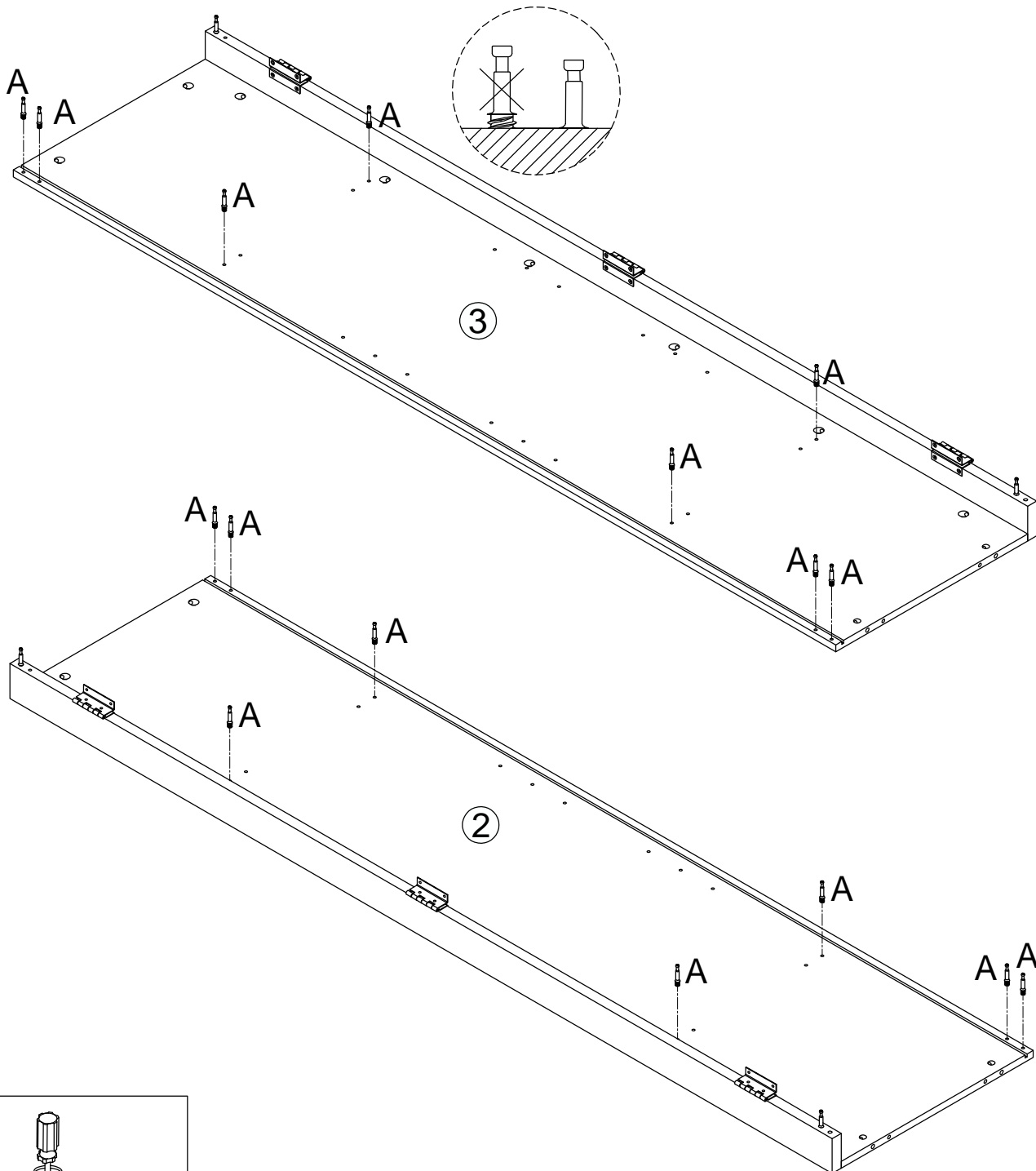

Step 5



Ø15X9mm

Ⓑ x6pcs



Ø6X30mm

Ⓒ x2pcs

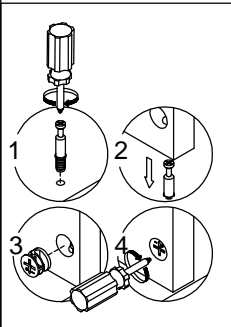
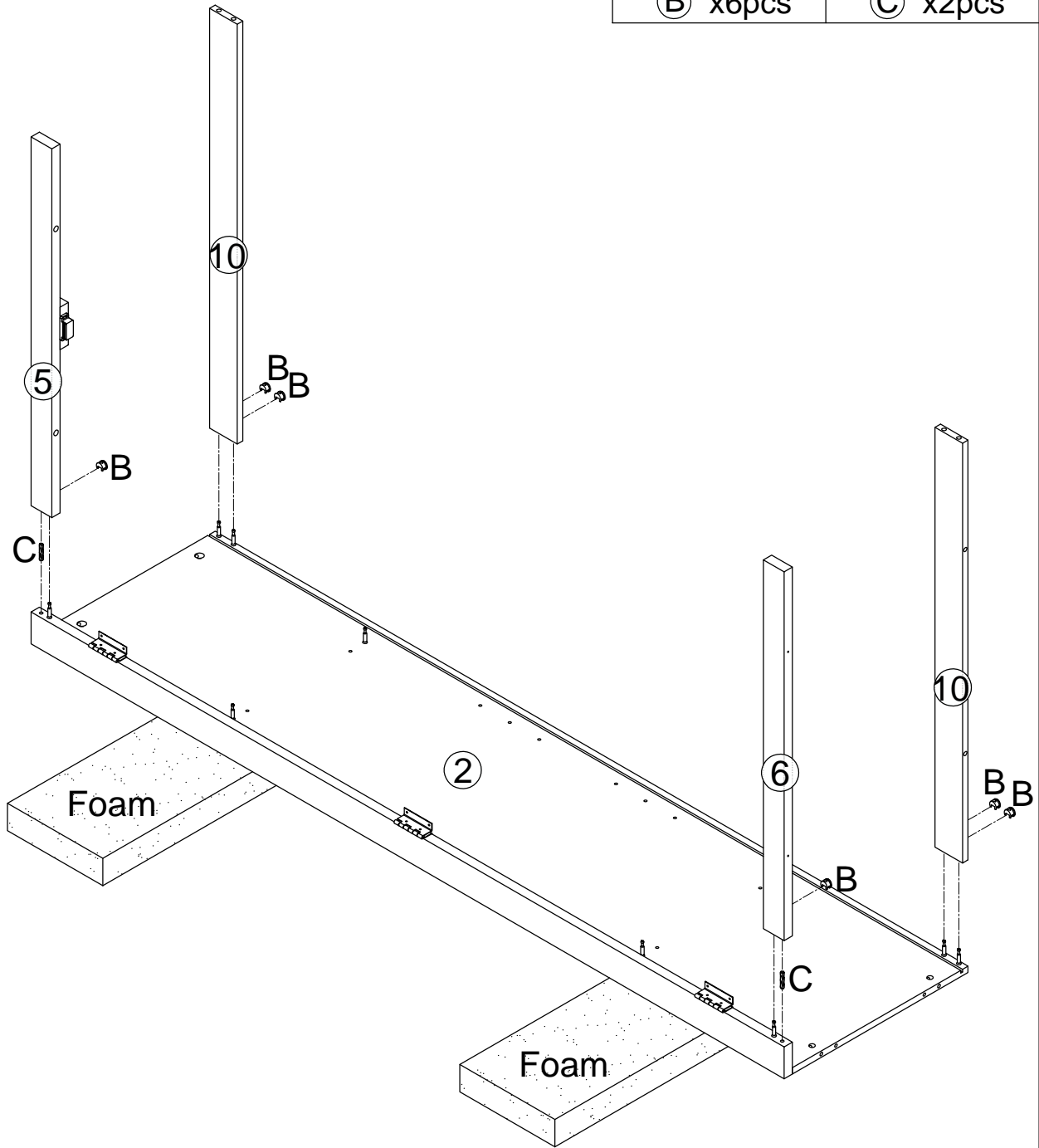

Step 6



Ø15X9mm

(B) x4pcs



Ø6X30mm

(C) x4pcs

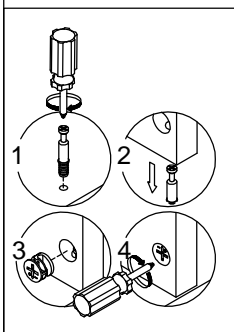
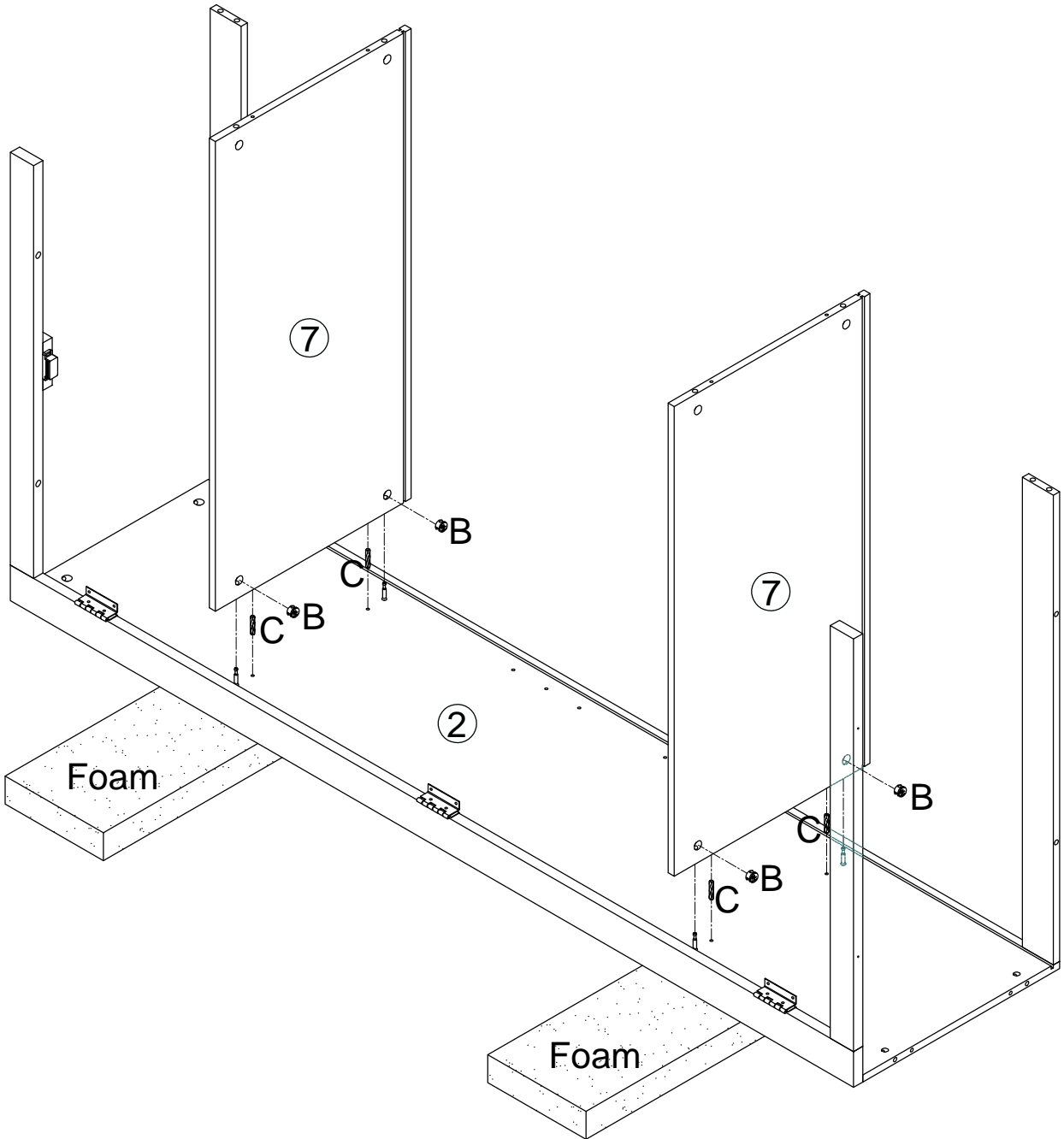

Step 7

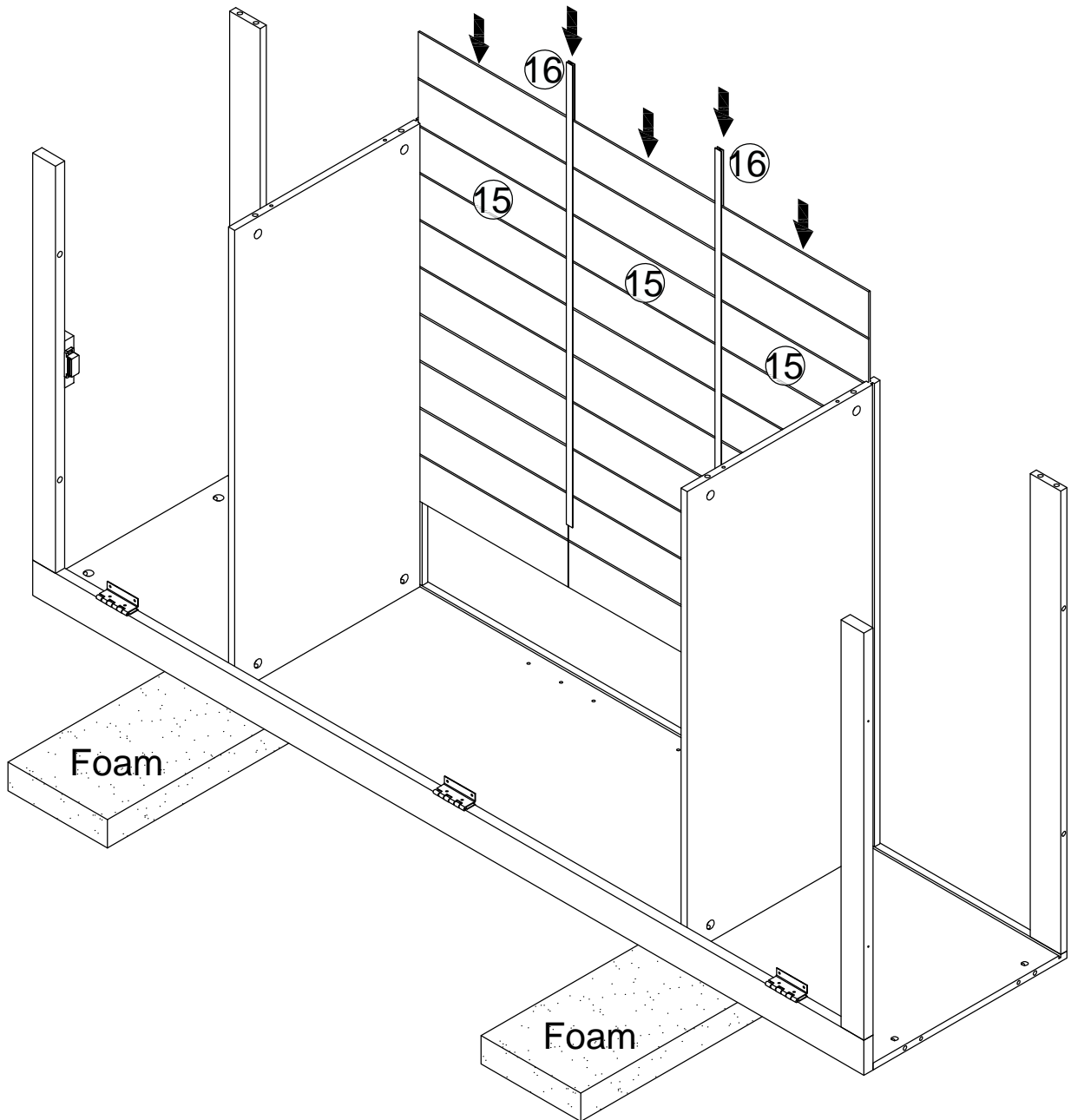

Step 8



Ø15X9mm

(B) x10pcs



Ø6X30mm

(C) x6pcs

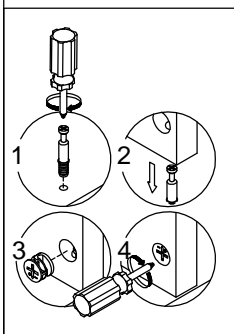
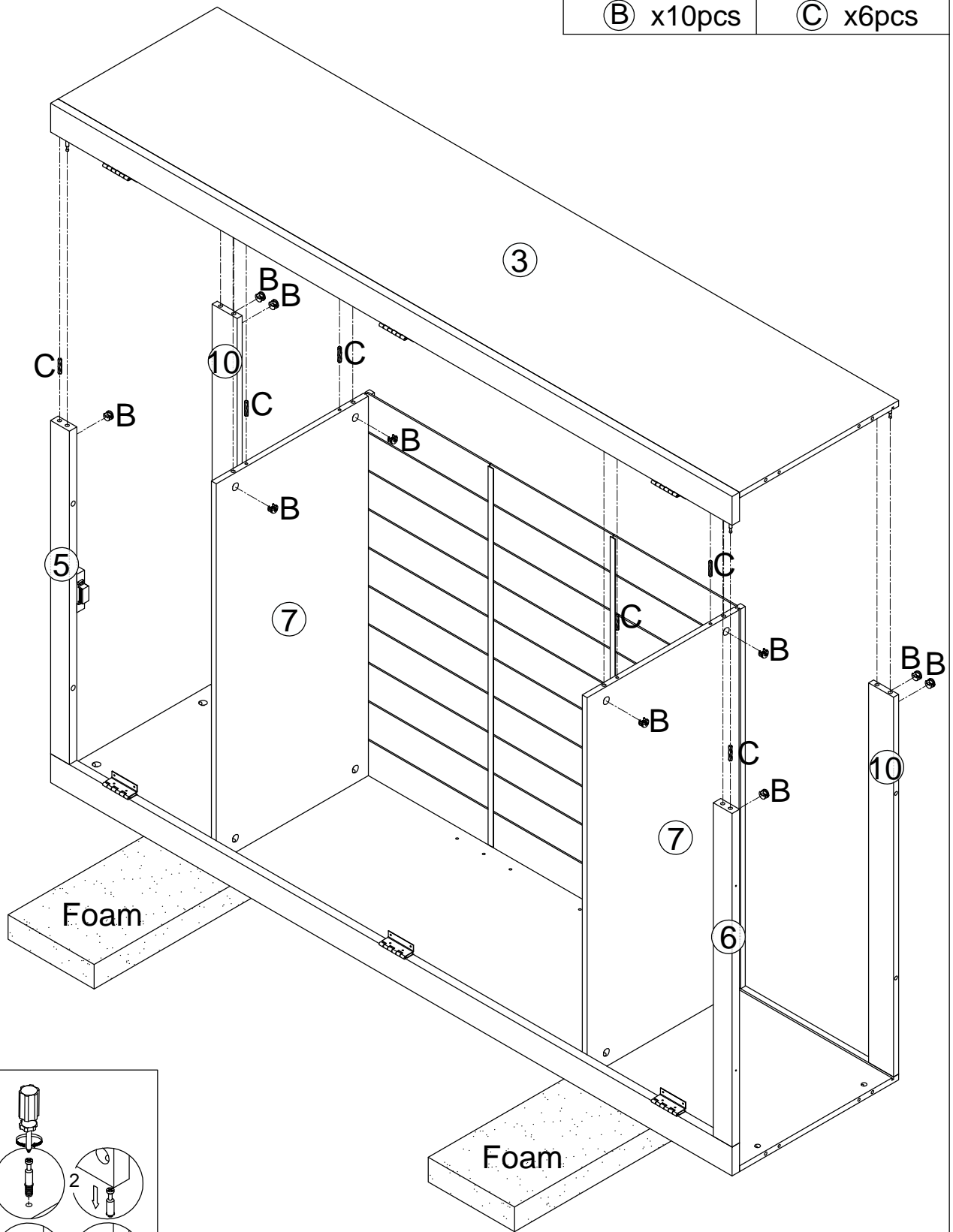

Step 9

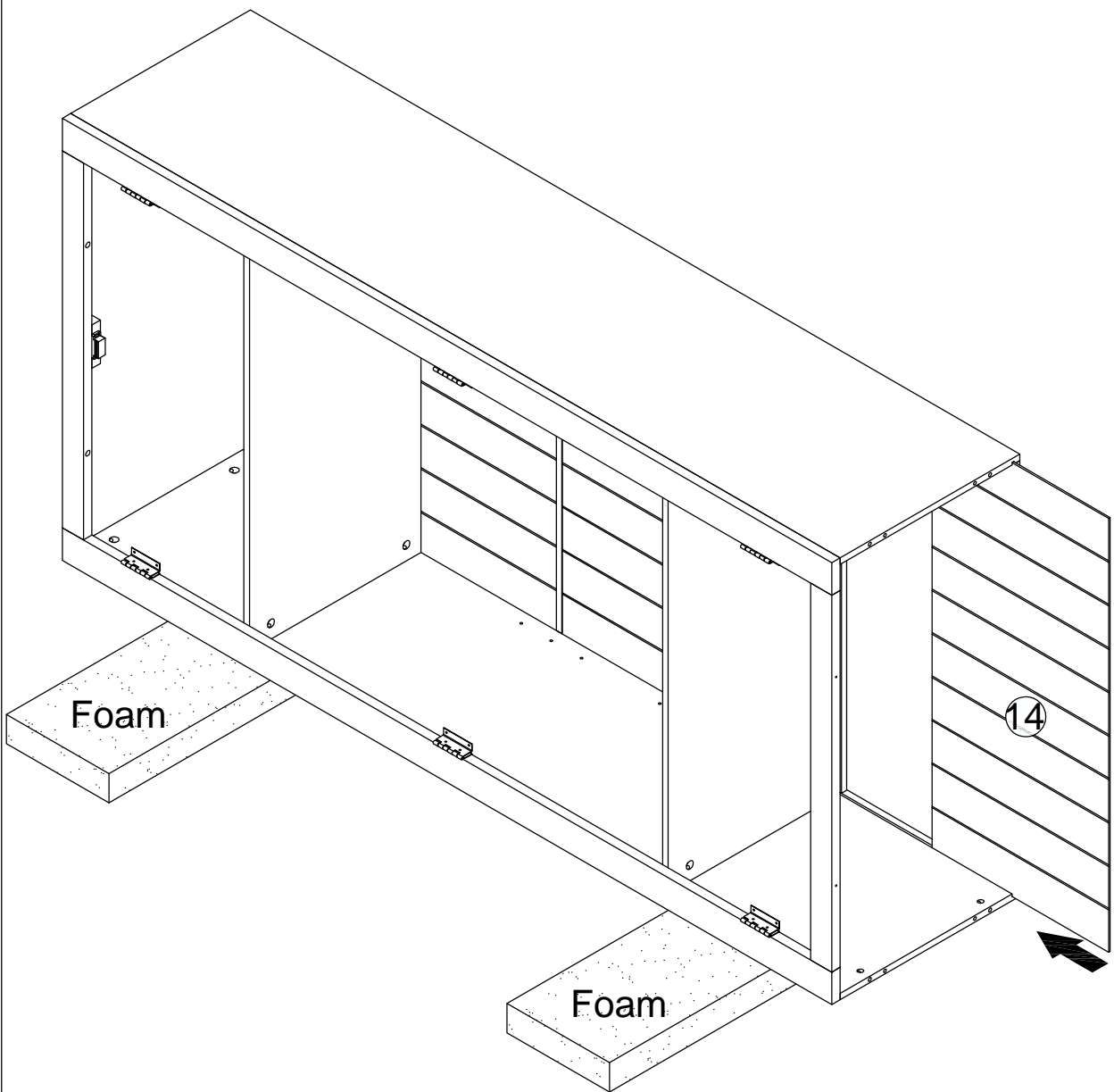

Step 10

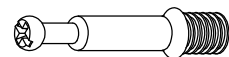

Ø6.5X35mm



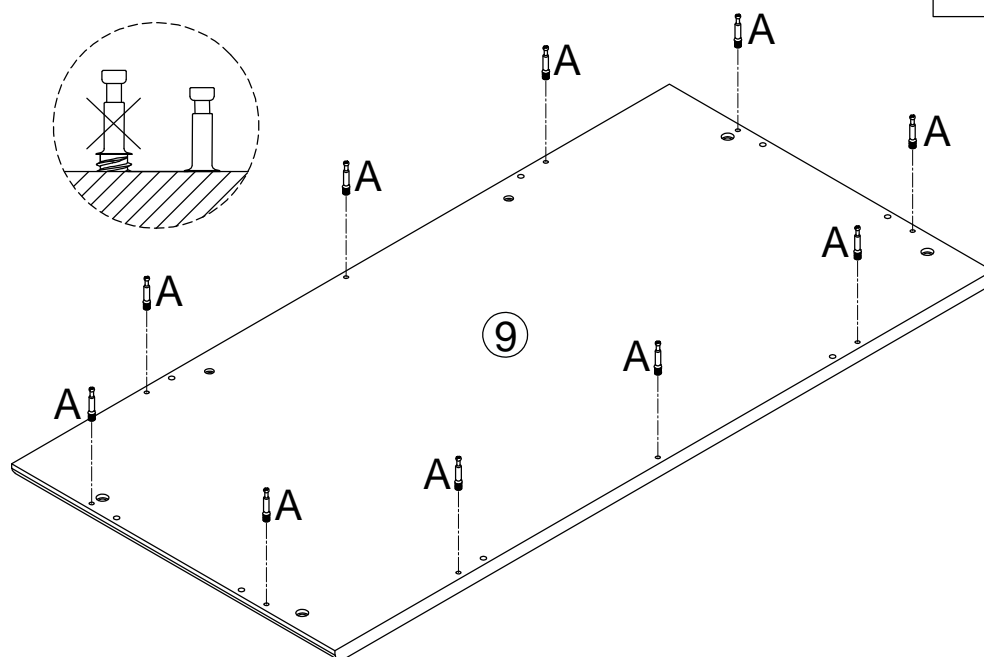
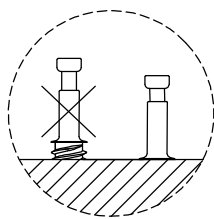

(A) x12pcs

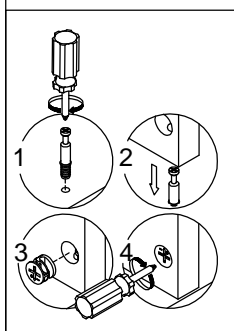
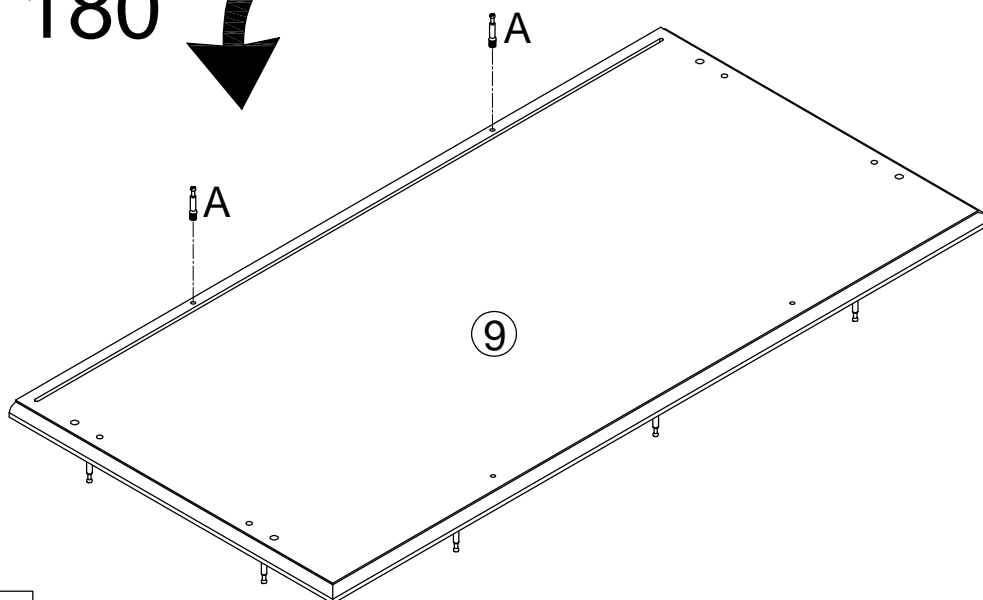

180°

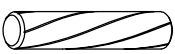

Step 11

				
Ø15X9mm	Ø6X30mm	Ø4X30mm	Ø6X40mm	Ø10X10mm
(B) x2pcs	(C) x4pcs	(D) x2pcs	(L) x4pcs	(M) x4pcs

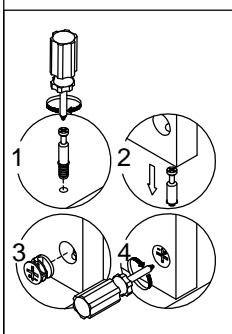
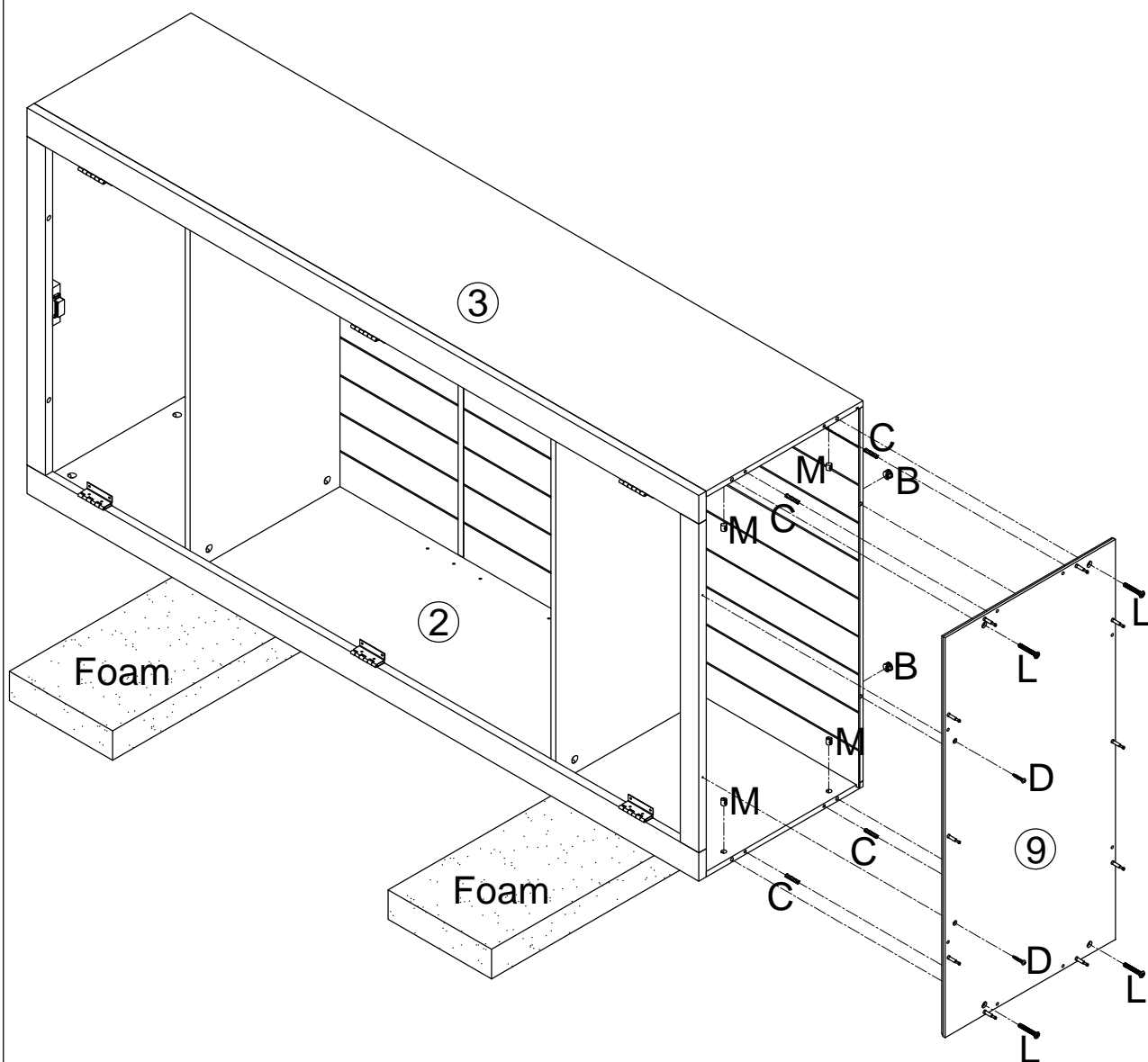

Step 12

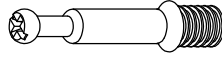

Ø6.5X35mm

Ⓐ x8pcs



Ø15X9mm

Ⓑ x8pcs

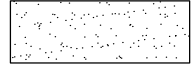

Ⓞ x8pcs

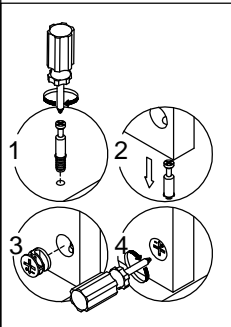
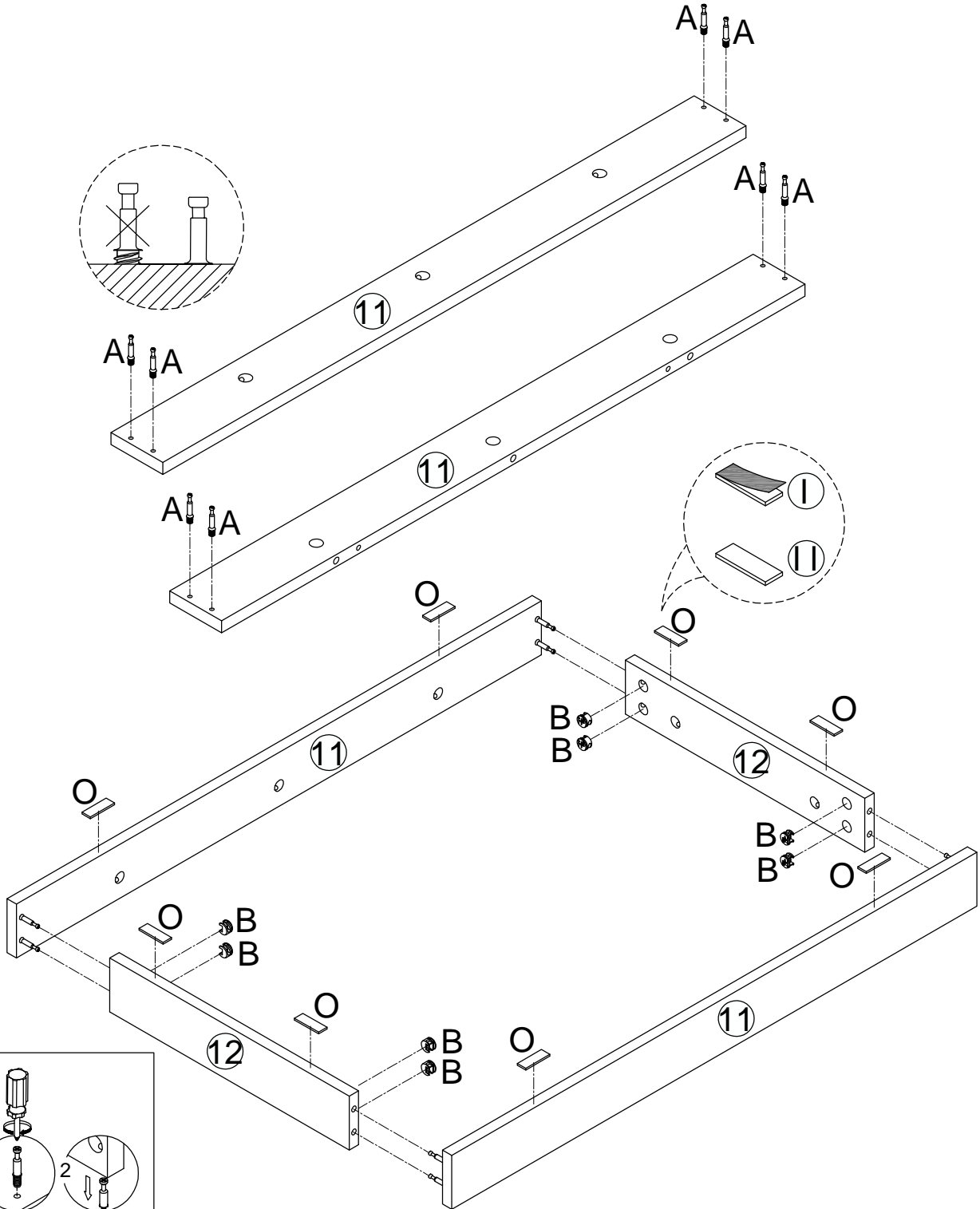
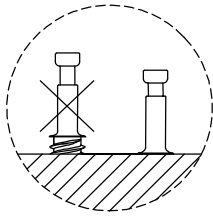

Step 13



Ø15X9mm

Ⓑ x10pcs



Ø6X30mm

Ⓒ x8pcs

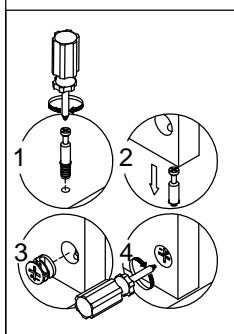
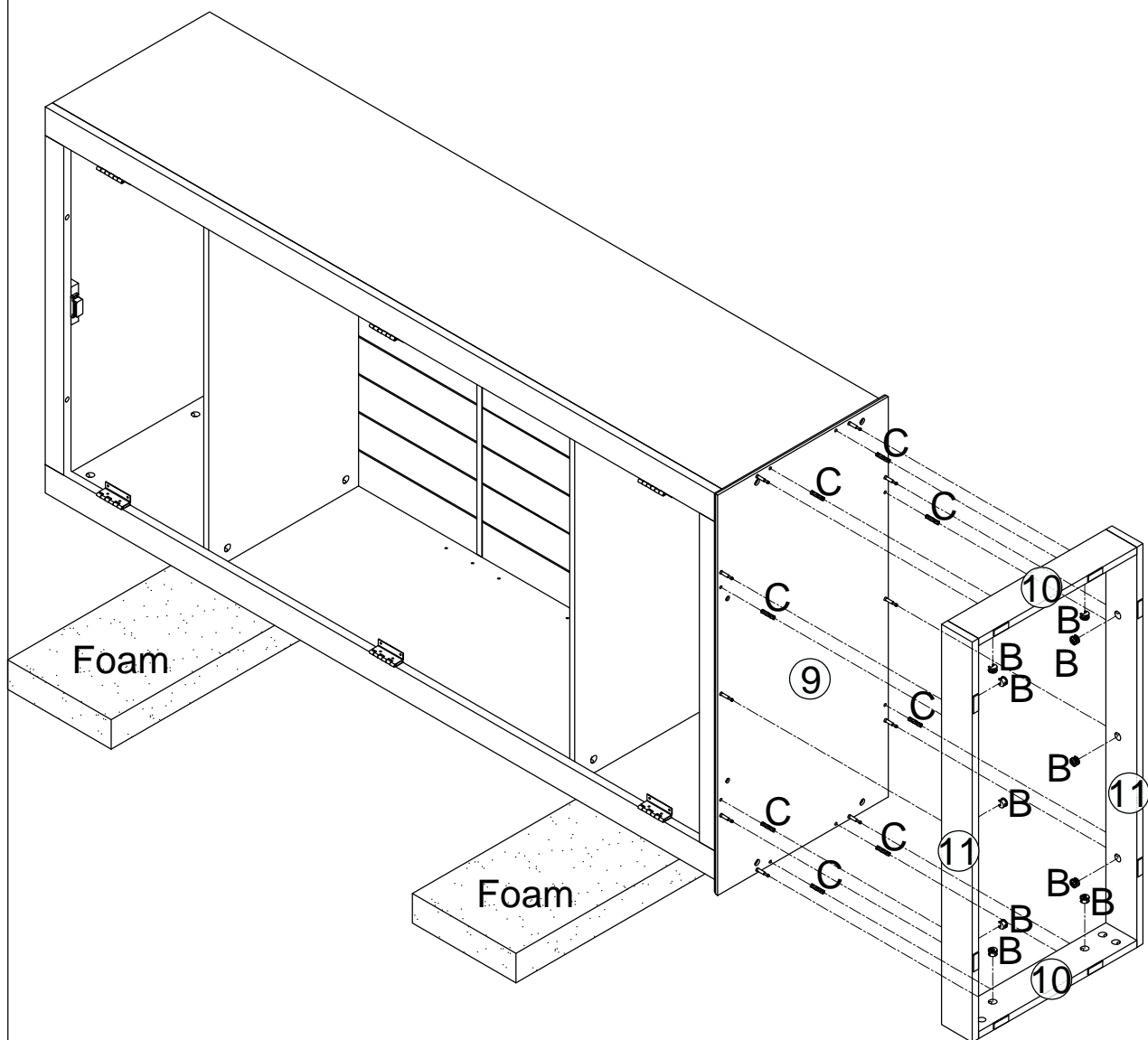

Step 14

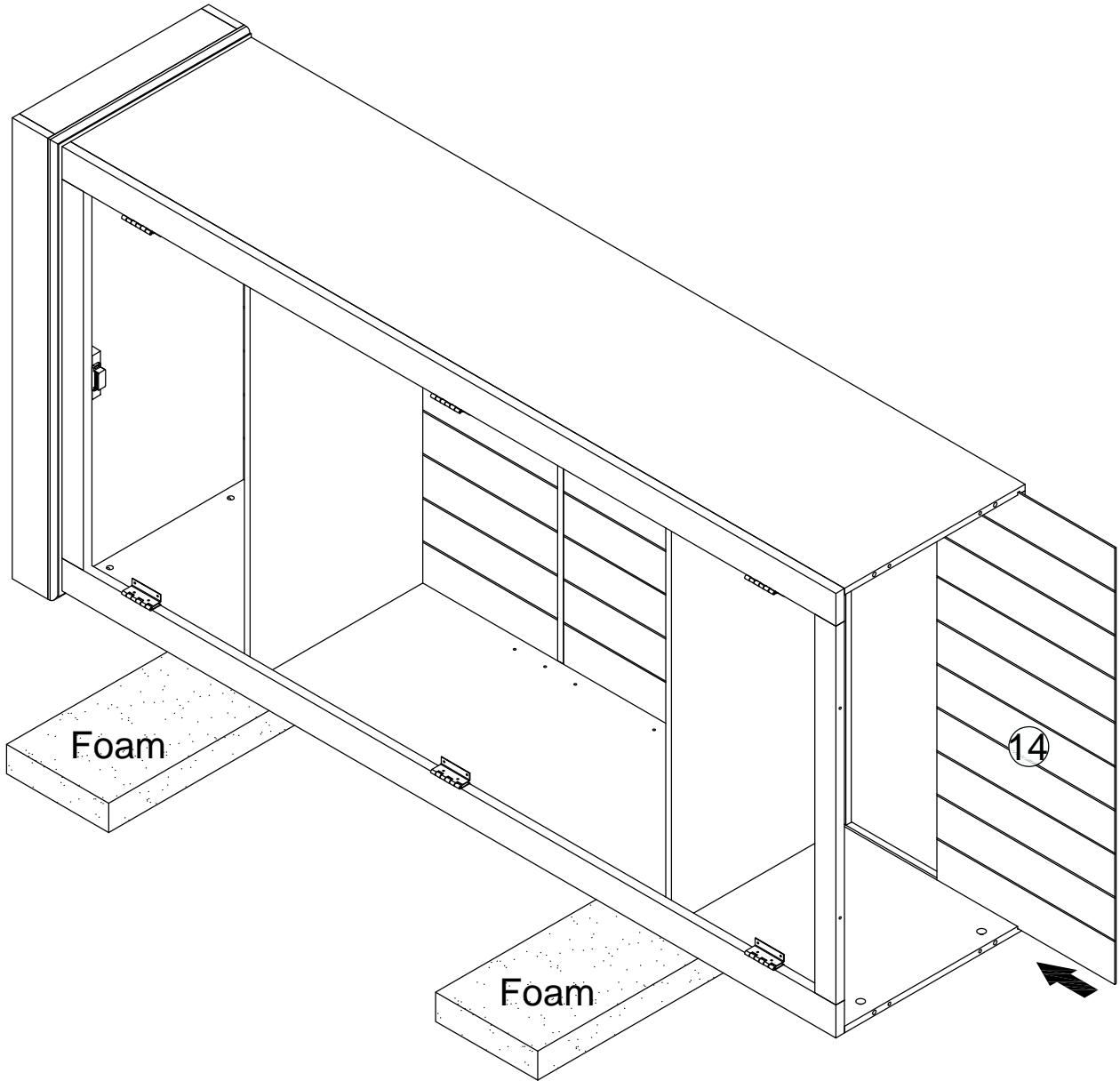

Step 15

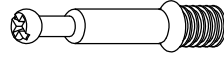

Ø6.5X35mm

(A) x6pcs



Ø4X14mm

(P) x2pcs

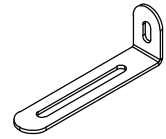

65X15X32mm

(S) x2pcs

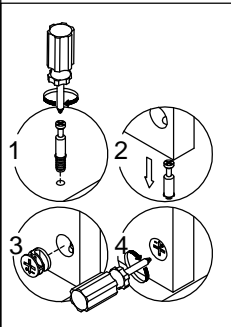
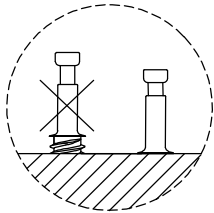
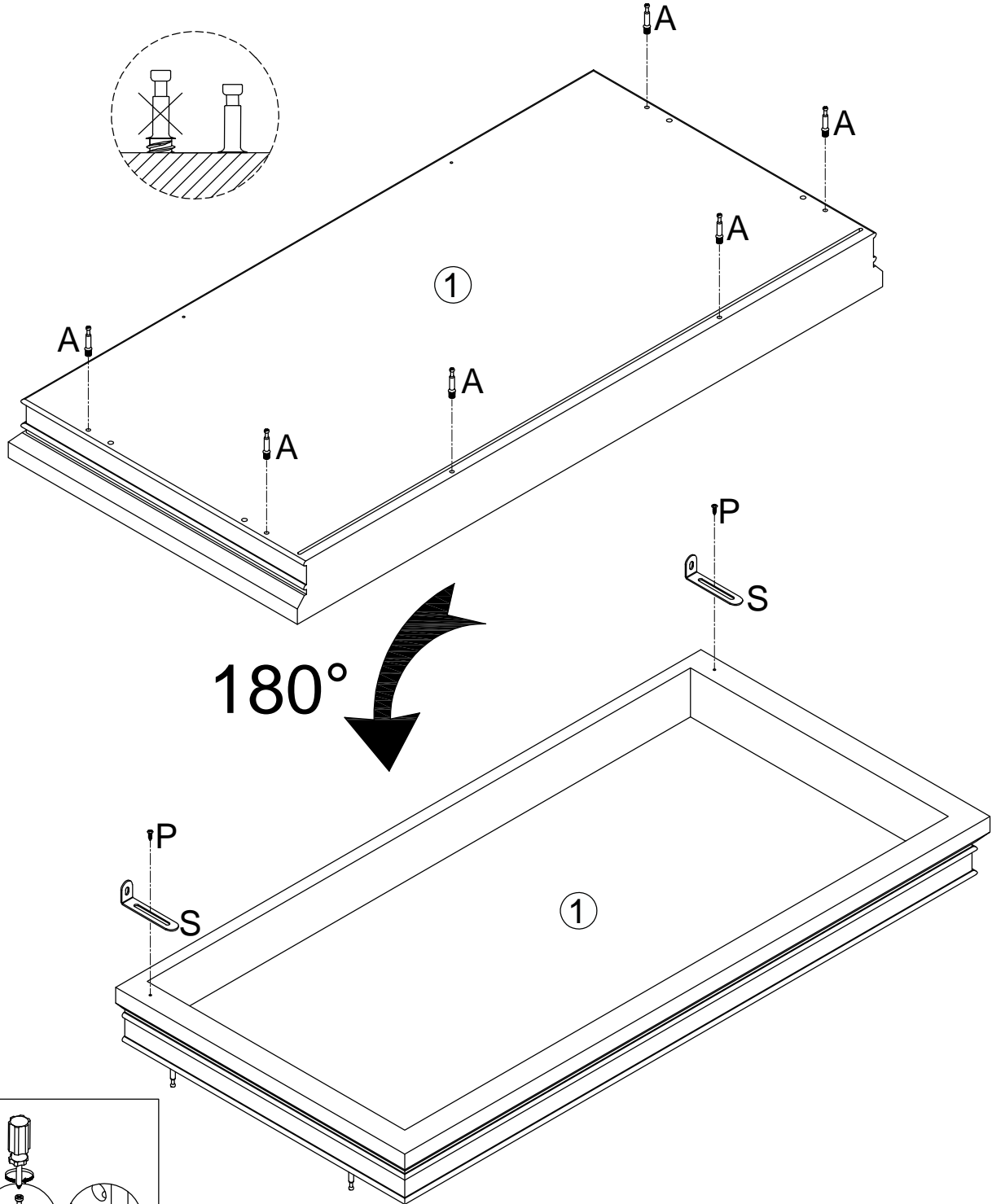

Step 17

x2

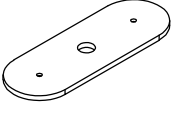
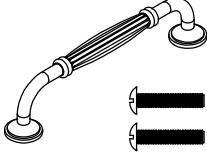
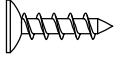
		
ⓐ x4pcs	Ⓛ x2pcs	Ø3X12mm Ⓚ x4pcs

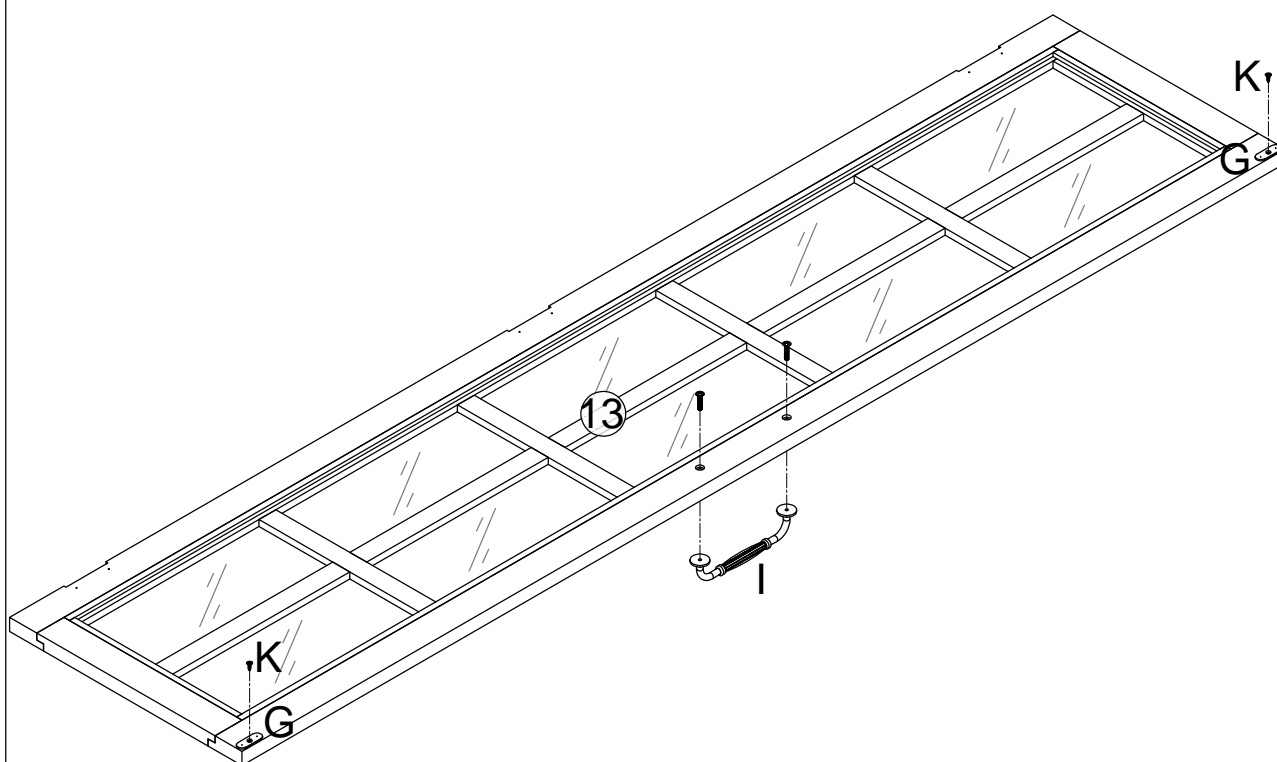

Step 18

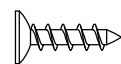

Ø3X12mm

K x24pcs

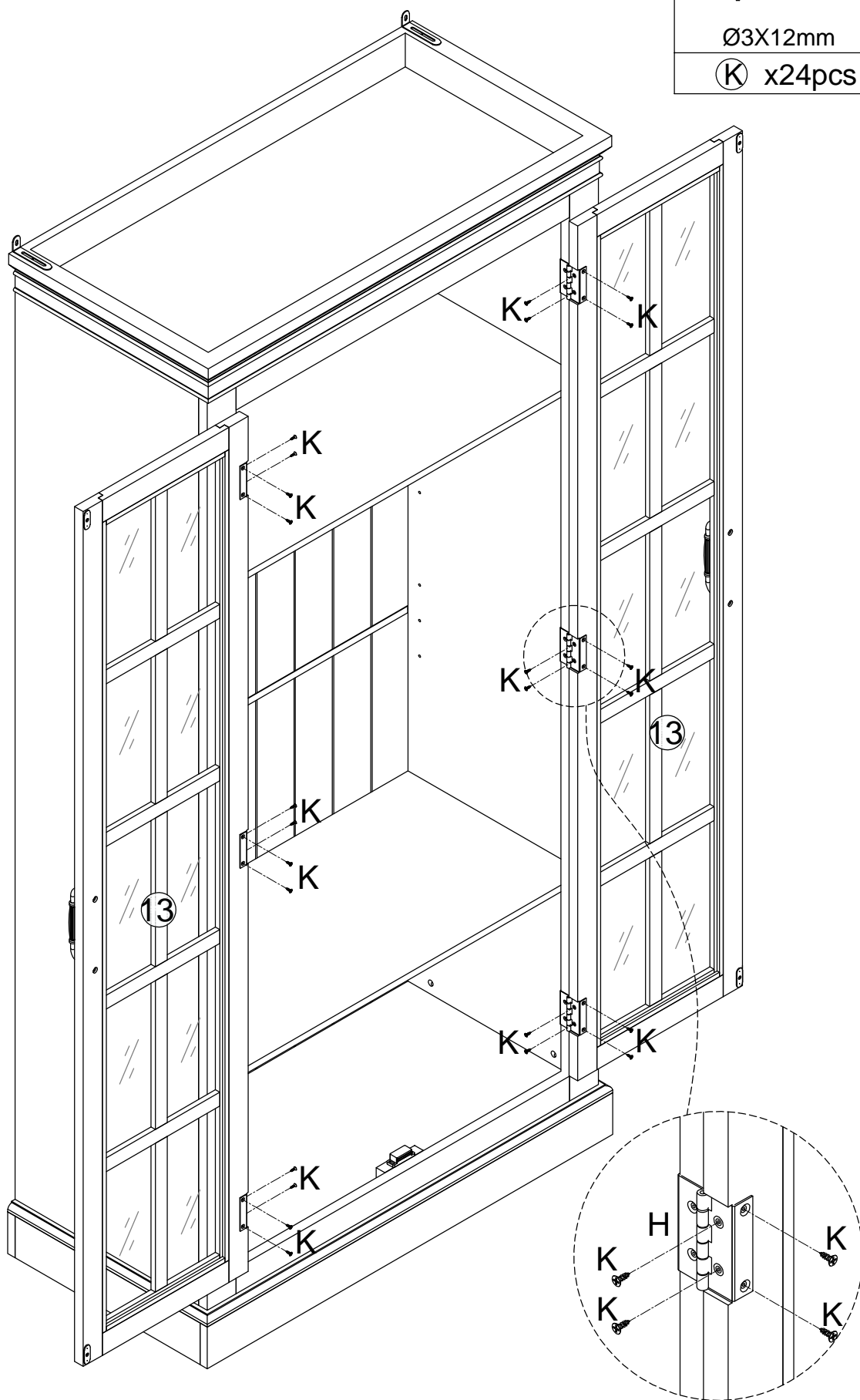

Step 19



J x8pcs

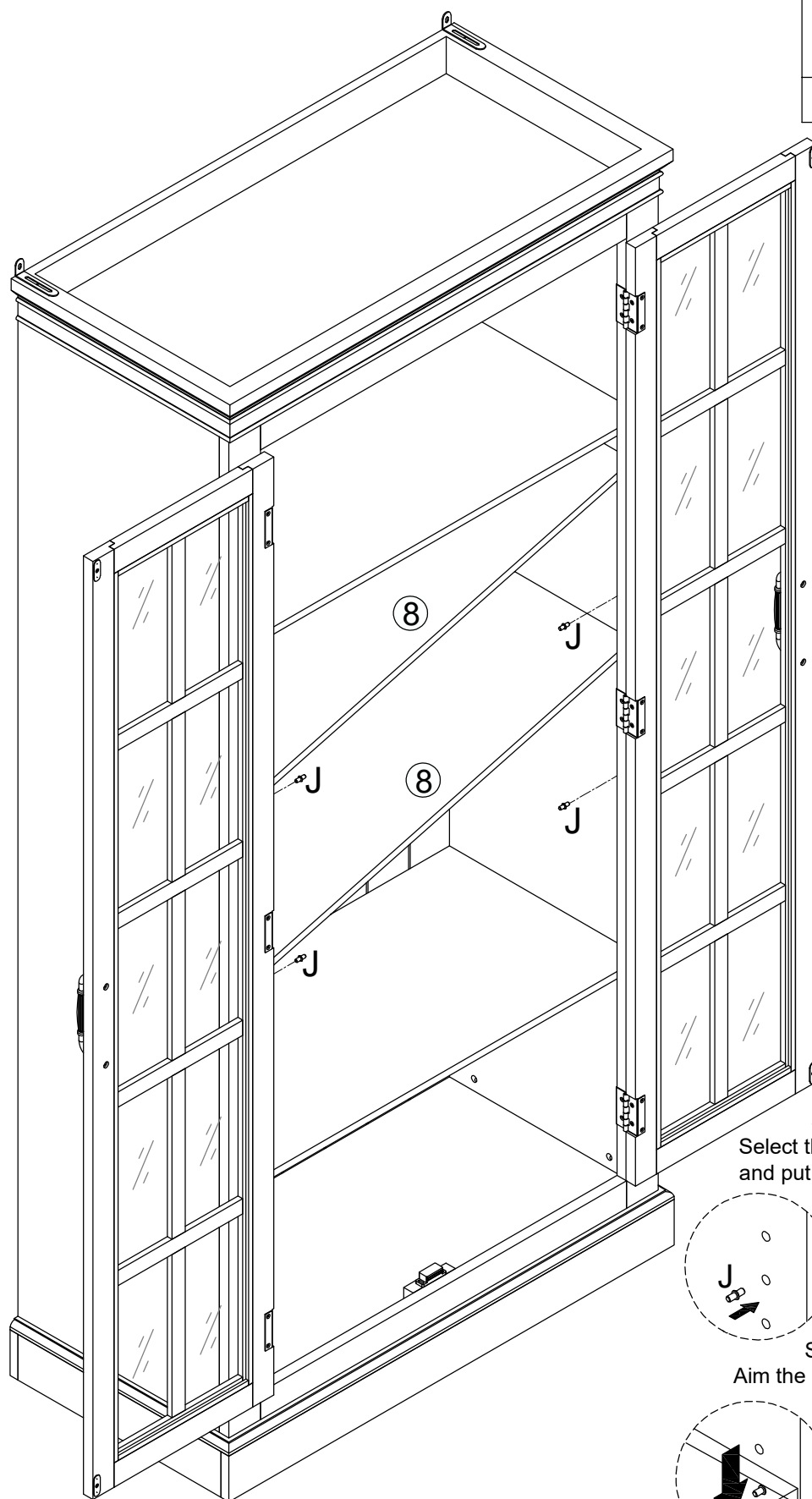

Step1
Select the desired height
and put it in

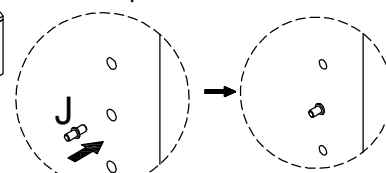

Step2
Aim the board gaps down

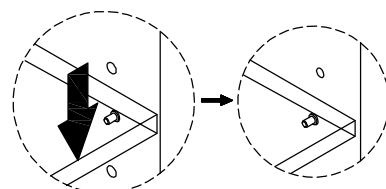

Step 20

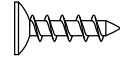

Ø3X14mm

(E) x20pcs



(N) x20pcs

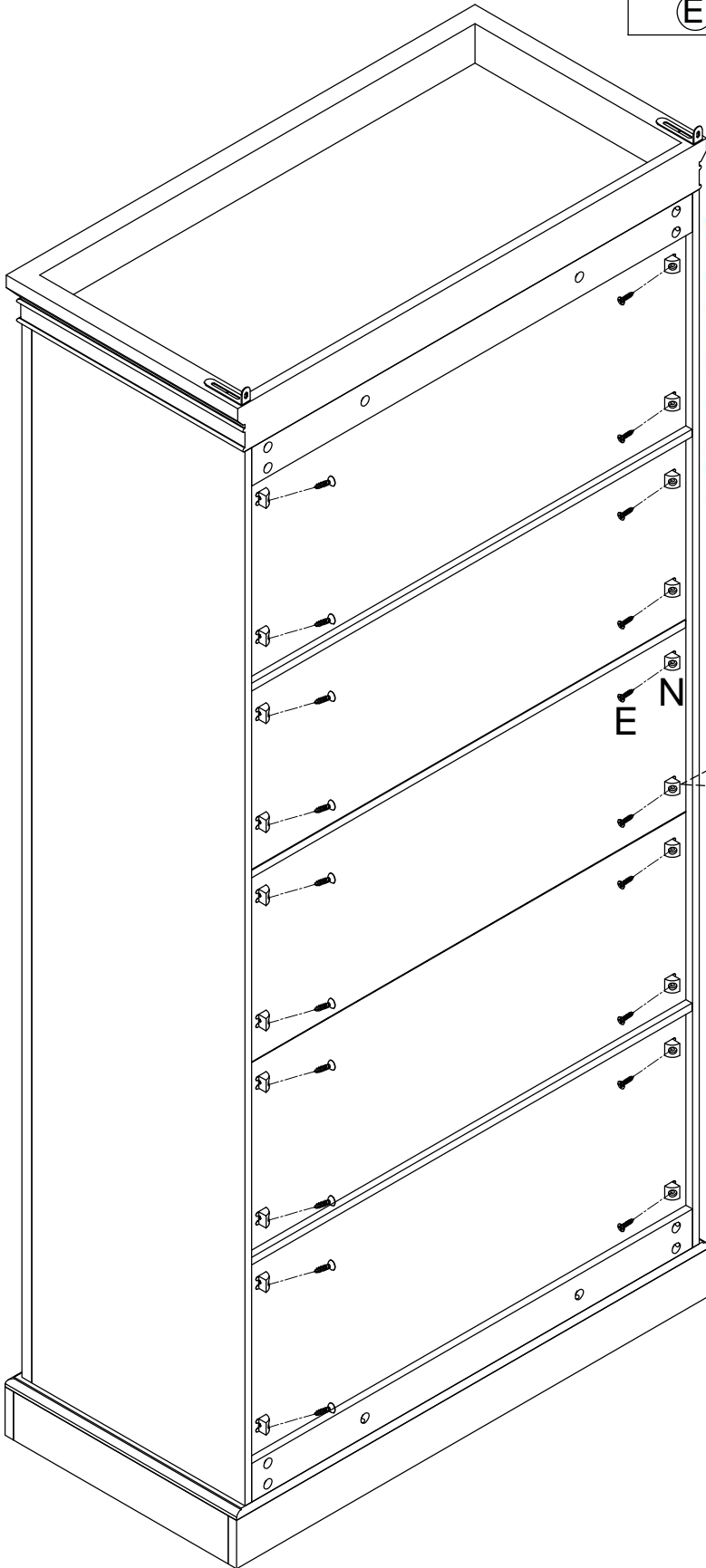

⚠ WARNING
Children have died from furniture tipover. To reduce the risk of furniture tipover:

- ALWAYS install Anti-tip device provided.
- NEVER put a TV on this product.
- NEVER allow children to stand, climb or hang on drawers, doors, or shelves.
- NEVER open more than one drawer at a time.
- Place heaviest items in the lowest drawers.

This is a permanent label. Do not remove!

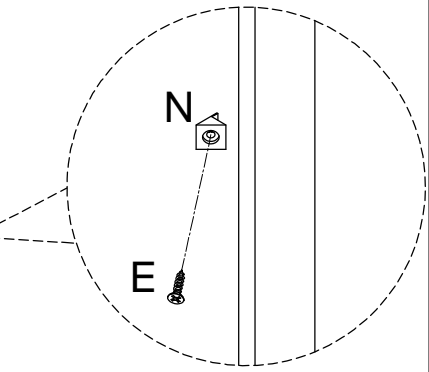

Step 21

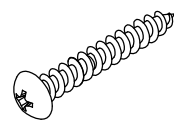

Ø4X40mm

Ⓚ x2pcs

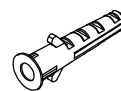

Ø8X38mm

Ⓚ x2pcs

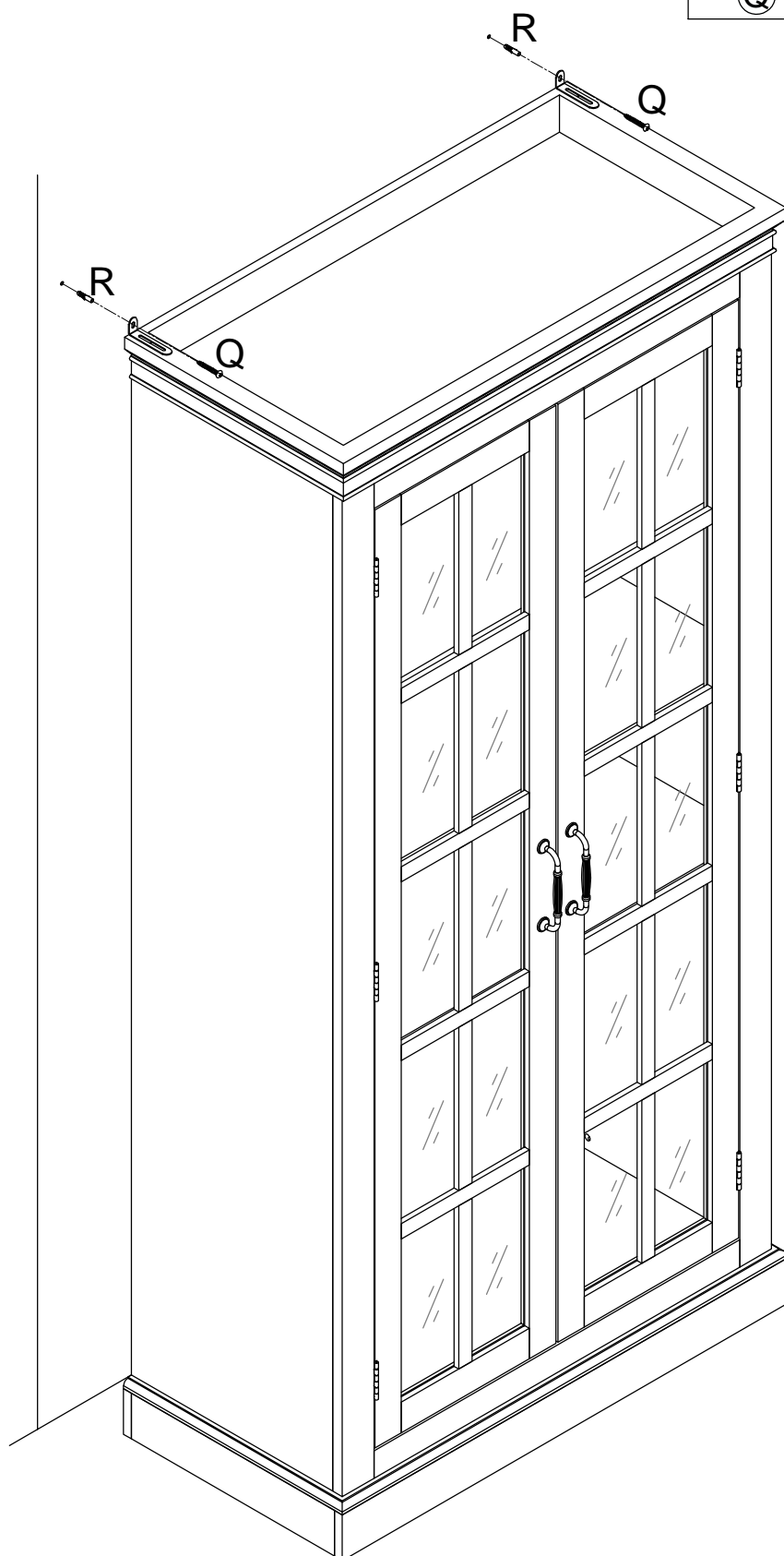

Attention: For safety and stability, we suggest securing the anti-tip accessories to the wall to prevent tipping, injury, and property damage.