

# ASSEMBLY INSTRUCTION

SRN-TR3011

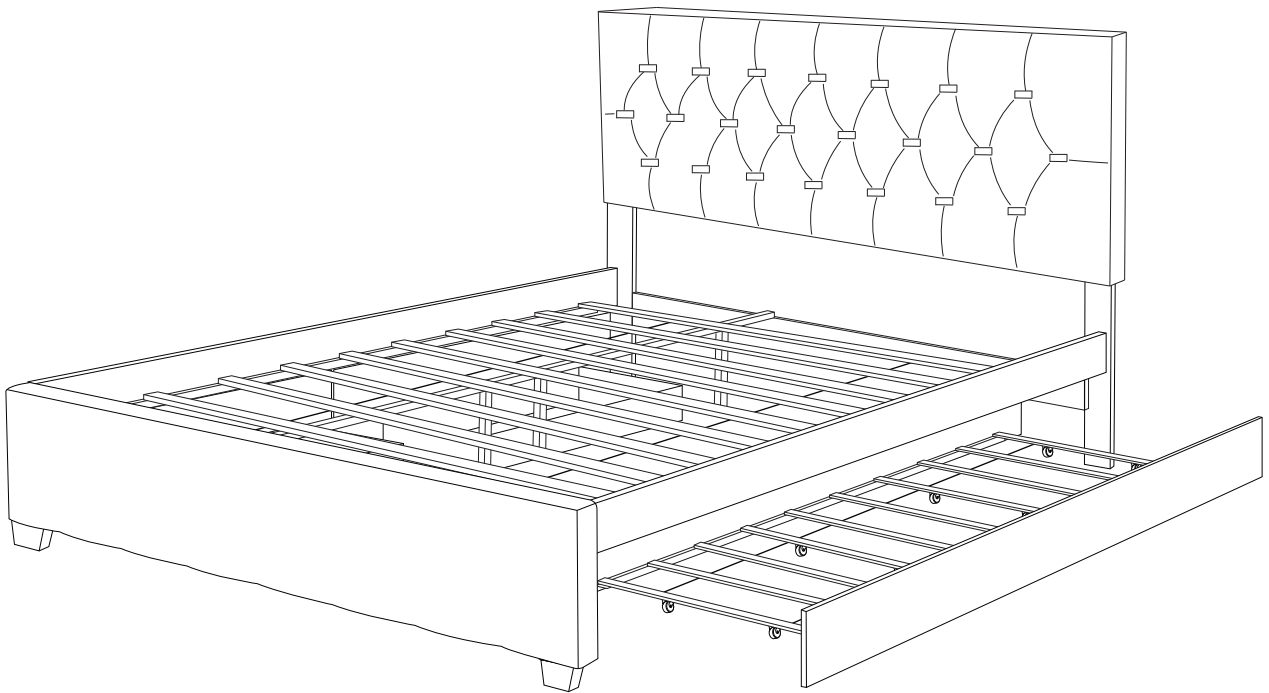

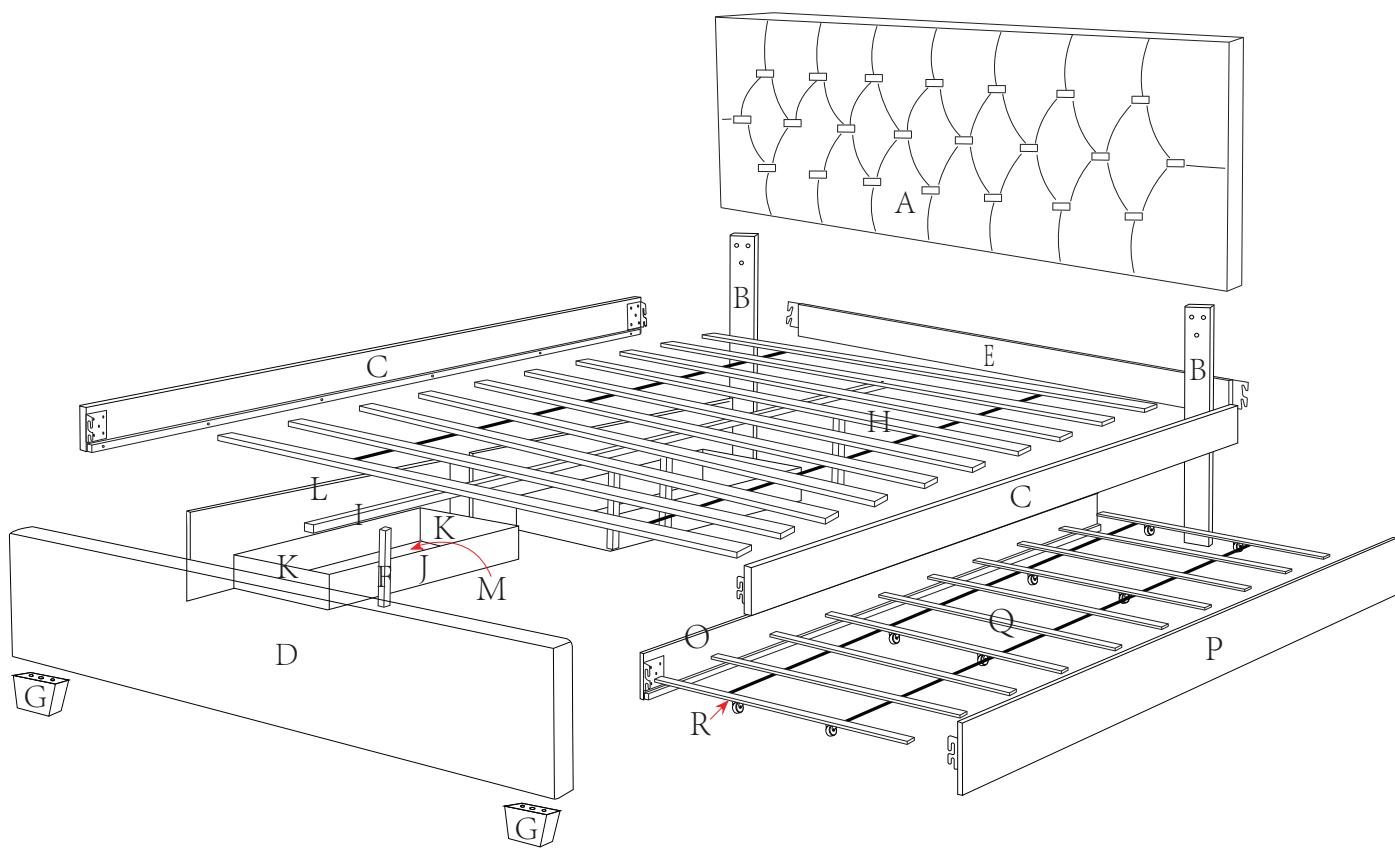

Detail View - TRUNDLE BED (QUEEN)



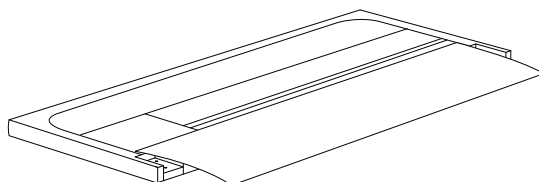

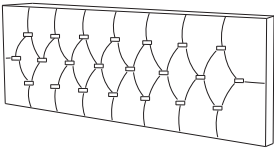
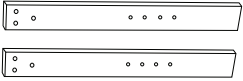

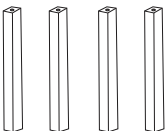
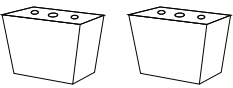
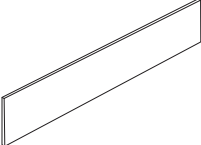
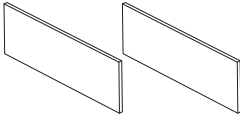
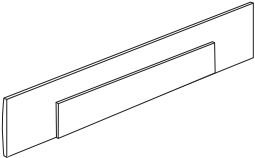
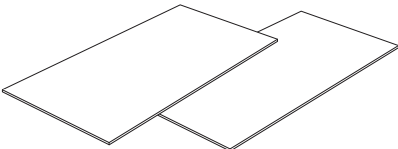

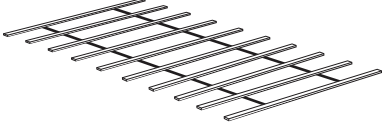
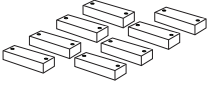

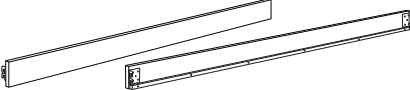
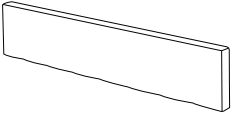
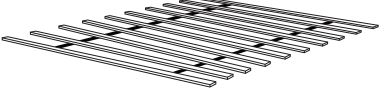

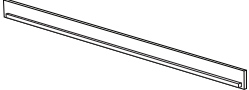
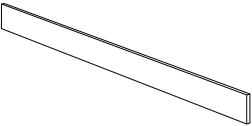
Bed Parts are shipped inside a compartment in the back of the headboard.

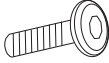

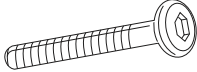
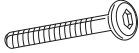
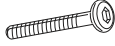
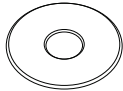

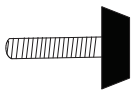

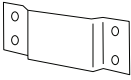
NO	PARTLIST (BOX 1 OF 2)	QTY
A	Headboard 	1 pc
B	Headboard Leg 	2 pcs
E	Headboard Support Bar 	1 pc
F	Center Support Leg 	4 pcs
G	Bed Leg 	2 pcs
J	Drawer Back Panel 	2 pcs
K	Drawer Side Panel 	4 pcs
L	Drawer Front Panel 	2 pcs
M	Drawer Bottom Panel 	2 pcs

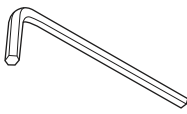
NO	PART LIST (BOX 1 OF 2)	QTY
Q	Trundle Bed Slat 	10 pcs
R	Trundle Slat Cube 	8 pcs

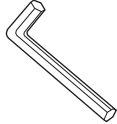
PART LIST (BOX 2 OF 2)		
C	Side Rail 	2 pcs
D	Footboard 	1 pc
H	Bed Slat Queen 	10 pcs
I	Center Support Rail 	1 pc
O	Trundle Long Panel (i) 	1 pc
P	Trundle Long Panel (ii) 	1 pc

NO	HARDWARE LIST (BOX 1 OF 2)	QTY
1	JCBB M8 x 20mm 	8 pcs
2	JCBC M6 x 70mm 	2 pcs
3	JCBC M6 x 60mm 	4 pcs
4	JCBC M6 x 45mm 	7 pcs
5	JCBB M8 x 25mm 	4 pcs
6	Flat Washer M6 	7 pcs
7	Dowel M8 	4 pcs
8	Adjuster M6 	4 pcs
9	CSK M4 x 20mm 	10 pcs
10	U-Bracket 	1 pc
11	CSK M3.5 x 16mm 	56 pcs
12	CSK M4 x 30mm 	40 pcs
13	Allen Key M4(100mm) 	1 pc

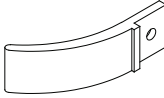
NO	HARDWARE LIST (BOX 1 OF 2)	QTY
14	Allen Key M5(65mm) 	1 pc
15	CSK M4 x 38mm 	16 pcs
16	Wheel 	16 pcs
17	CSK M4 x 32mm 	16 pcs
18	Stopper 	6 pcs

Read this instruction carefully. Remove all wrapping material, staples and straps from the carton. See hardware and furniture part list for guidance. Be sure you have all wooden furniture parts on a clean and flat surface, such as carpet or rug, to prevent from being scratched.

**CAUTION :**

1. Do not Full Tighten the nut or screw until all ready to assemble.
2. Do not Over Tighten the nut or screw to avoid causing damages to the thread.
3. Keep all hardware part out reach of children.

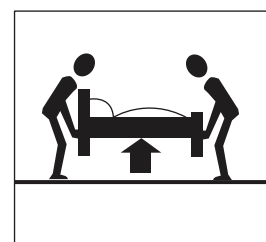
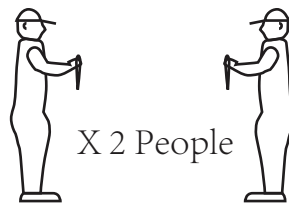

**STEP 1** Trundle Bed x 1 pc

11	12	16	17
32 pcs	20 pcs	8 pcs	16 pcs

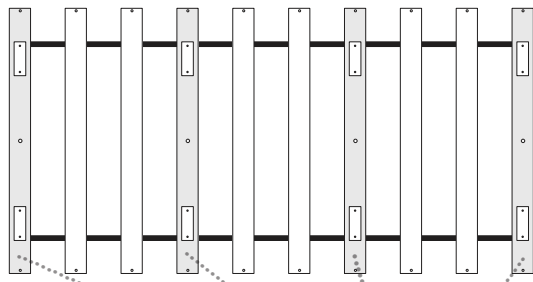

Step 1

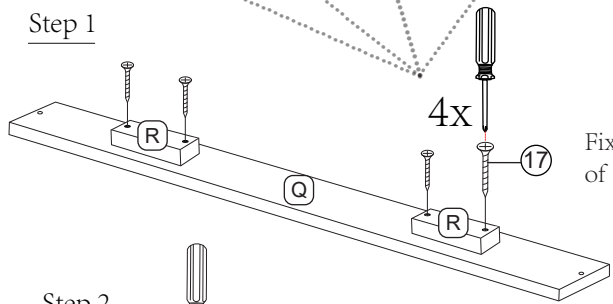

Fix the cube at the bottom of 1st, 4th, 7th, and 10th slat.

COMPLETED ASSEMBLY

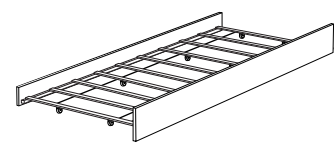

Step 2

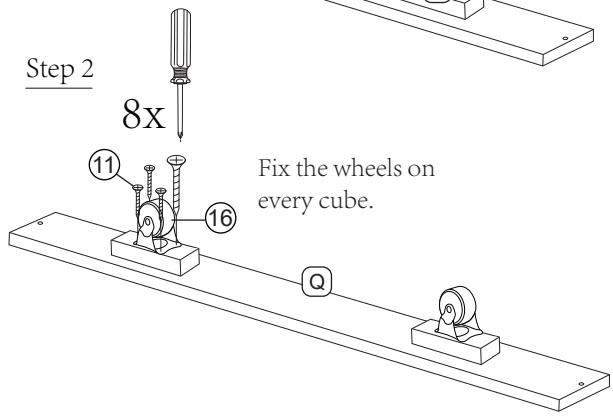

Fix the wheels on every cube.

Step 3

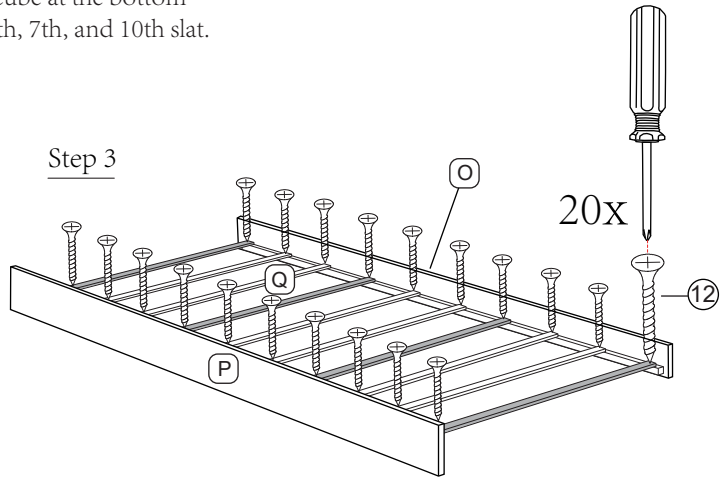

**STEP 2** Drawer x 2 pcs

11	15	16
24 pcs	16 pcs	8 pcs

Step 1

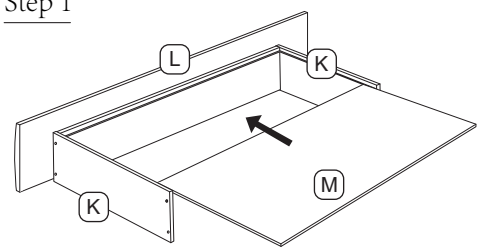

Step 2

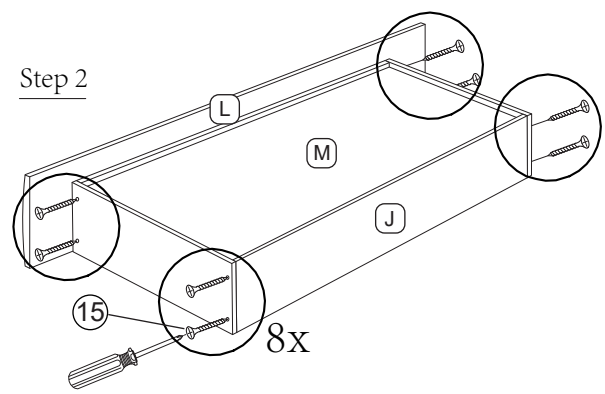

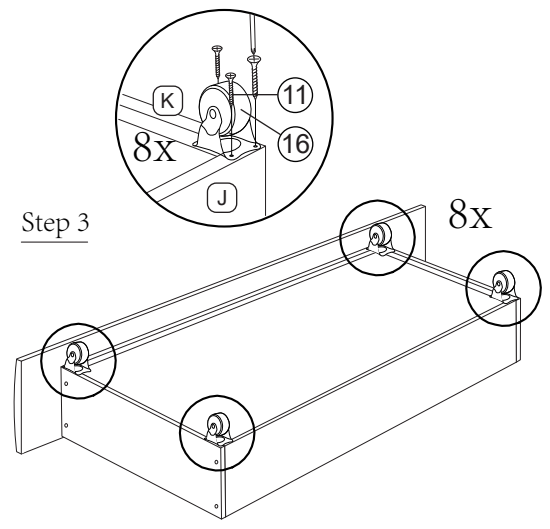

Step 3

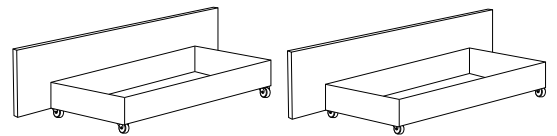

COMPLETED ASSEMBLY

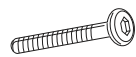

STEP 3

<p>2</p> 	<p>4</p> 	<p>6</p> 	<p>7</p> 
<p>2 pcs</p>	<p>6 pcs</p>	<p>6 pcs</p>	<p>4 pcs</p>

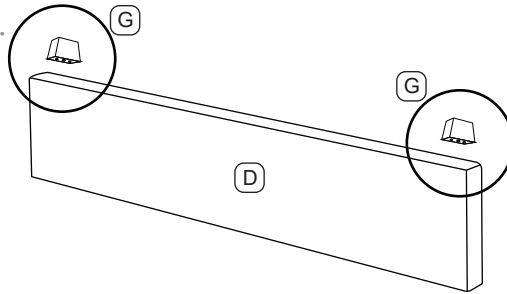
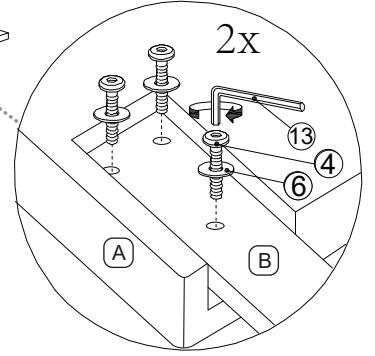
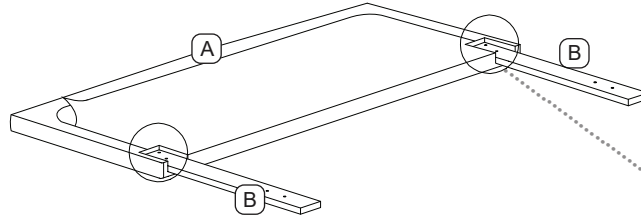
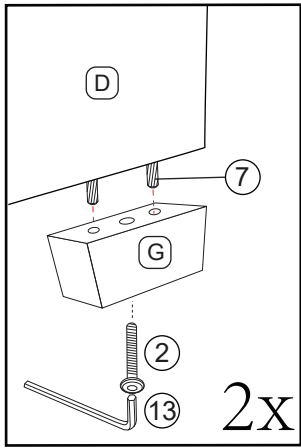

STEP 4

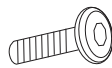
<p>1</p> 
<p>8 pcs</p>

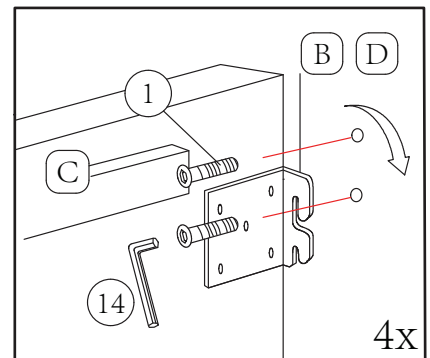
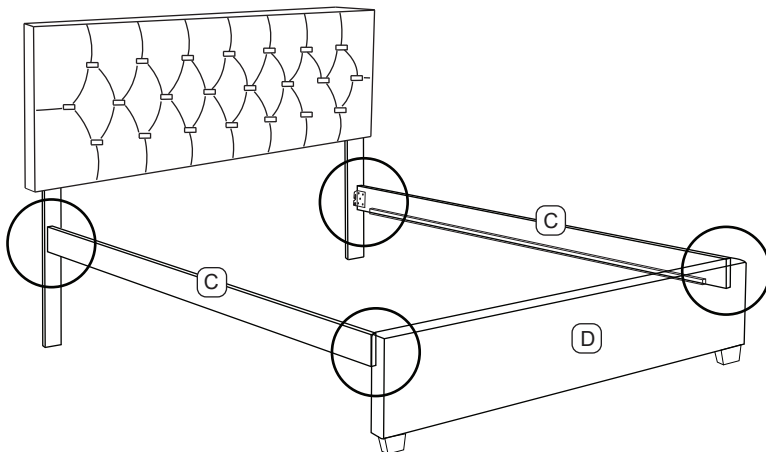

**STEP 5**

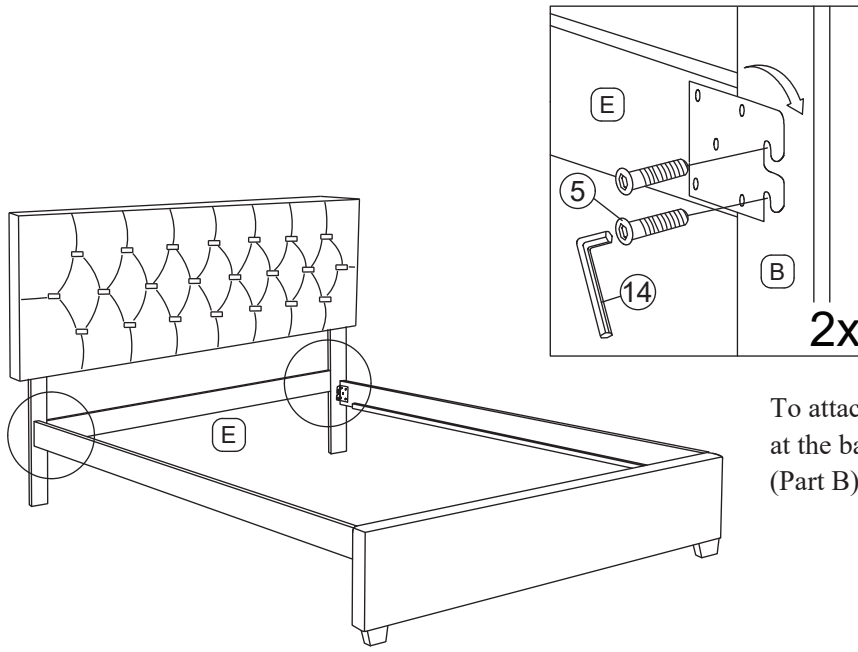

5

4 pcs

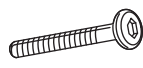

To attach the Headboard Support Bar at the backside to the Headboard Leg (Part B).

**STEP 6**

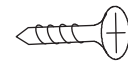
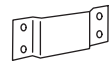
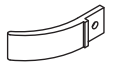
Decide the side for trundle bed & drawers

4	6	9	10	18
				
1 pc	1 pc	10 pcs	1 pc	6 pcs

Option 1

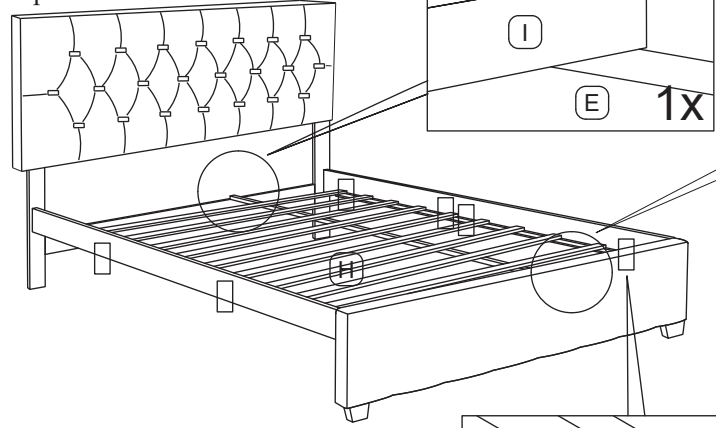

Option 2

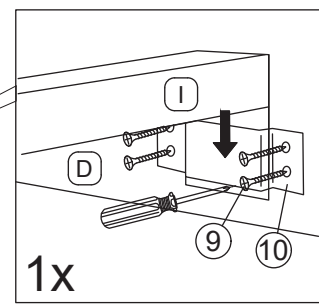
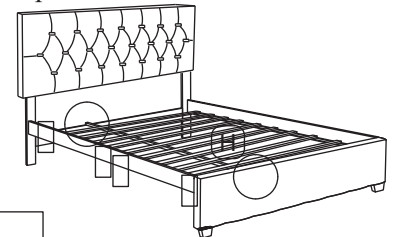

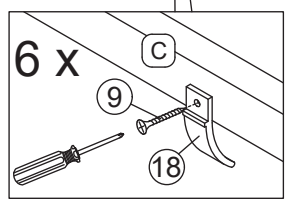

Follow the marking to attach the U-Bracket with Screw 20mm (4PCS) at Footboard.

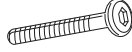

Optional:  
Add drawer stopper

STEP 7

3	8	12
		
4 pcs	4 pcs	20 pcs

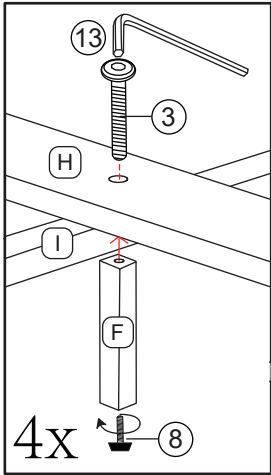

Adjust slat leveling feet to touch floor.

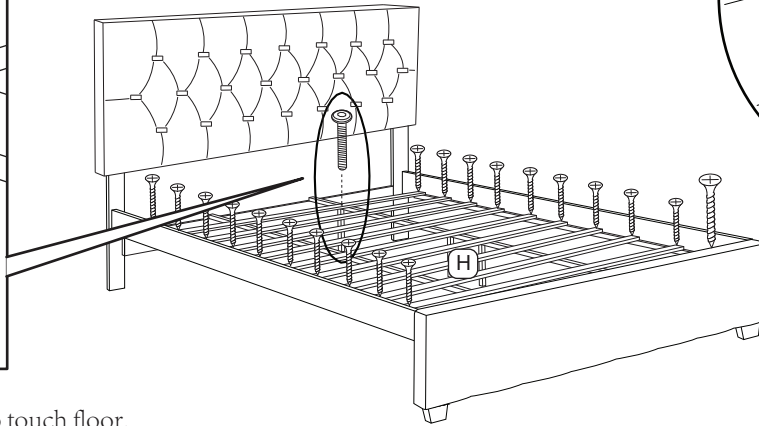

Lastly, place the trundle bed & drawers inside.

