

Assembly Instructions

Caution: You must read this before you proceed

Sets often ship in multiple boxes and may arrive a day or two apart.

NOTE: FOR RESIDENTIAL USE ONLY.
NOT INTENDED FOR COMMERCIAL PURPOSES



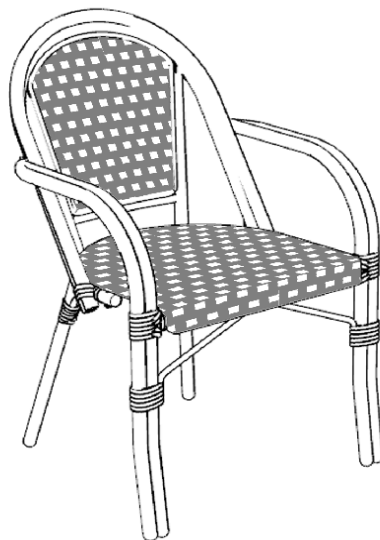



CHAIR



Part List

Label	Picture	Description	QTY
A		Front Leg & Armrest	1
B		Seat	1
C		Back Leg & Backrest	1

Hardware

Label	Picture	Description	QTY
①		Bolt (M6*45mm)	8
②		Bolt (M6*25mm)	3
③		Spring Washer	10
④		Washer	10
⑤		Rubber Washer	3
⑥		Allen Wrench(M6)	1

Assembly Preparation

Before Beginning Assembly:



A

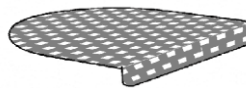

B

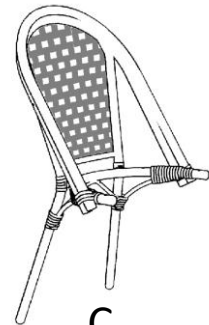

C



①x8



②x3



③x10



④x10



⑤x3



⑥x1



- Read instructions, cover to cover-



- Have 2 adults on hand for assembly-



- Do not assemble on flooring or carpet-



- Assemble on a clean non-marring surface (packing foam)-



- Save all packaging until finished-

Assembly Steps

Overview

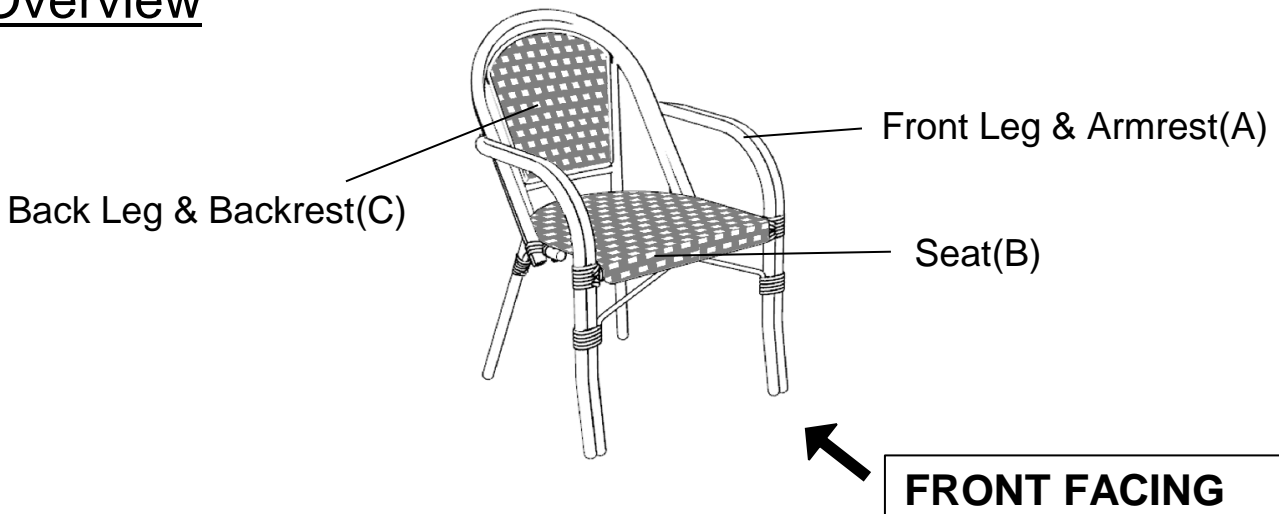

This Chair has multiple parts and may require up to 30 minutes to assemble. To give you an overview of the Chair parts, the above picture is to help you put the various parts into perspective. Please read through the instructions below to familiarise yourself with the parts and steps before assembly.

Step 1

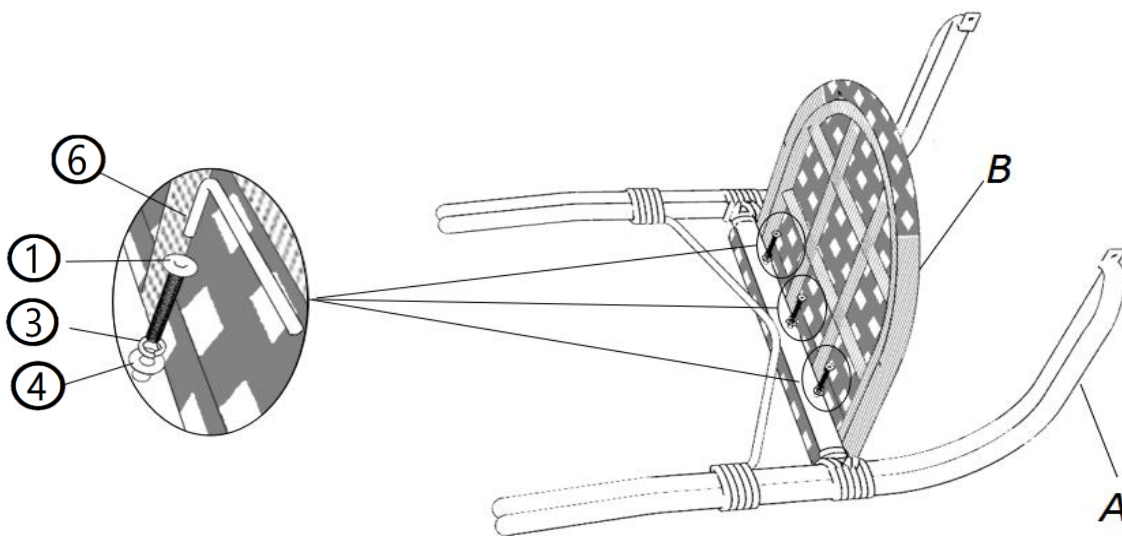

Open the carton and place all the parts onto a clean, non-marring surface. Attach the Seat (B) to the Front Leg & Armrest (A) using Bolts(①), Spring Washers(③) and Washers(④) with the Allen Wrench(⑥).

DO NOT fully tighten the bolts.

Note: Occasionally some of the PE wickers will cover the Bolt points, preventing easy assembly, the PE wicker should not be cut but moved away from the mounting positions.

Step 2

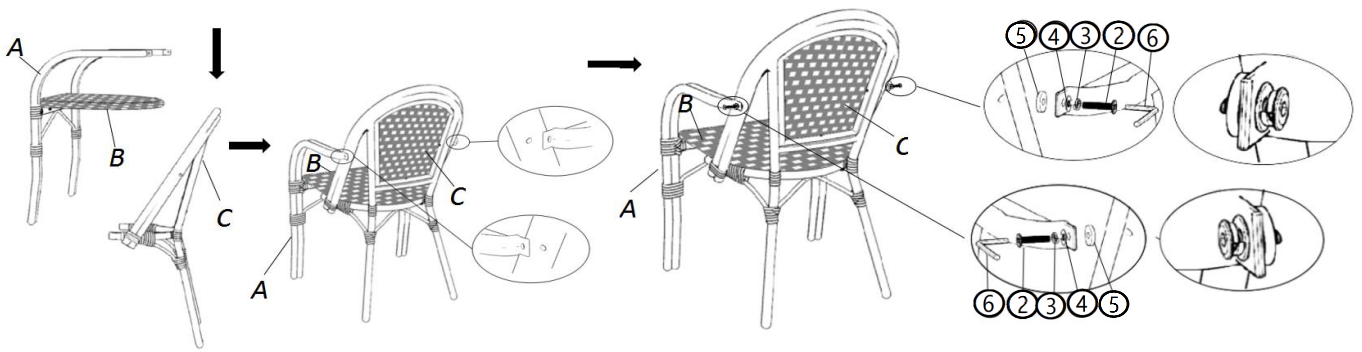

Lift up the Front Leg & Armrest (A) and the Seat (B), then move it down from the upward side of the Back Leg & Backrest (C) until the assembling holes fit.

Attach the Front Leg & Armrest (A) to the Back Leg & Backrest (C) using Bolts(2), Spring Washers(3), Washers(4) and Rubber Washers(5) with the Allen Wrench(6).

DO NOT fully tighten the bolts.

Step 3

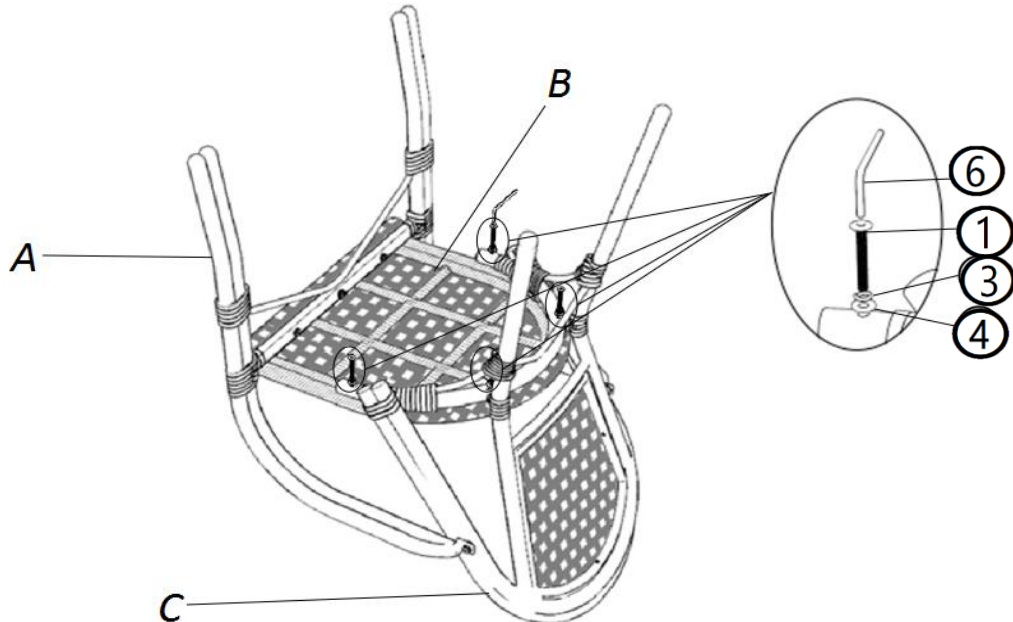

Turn the Chair upside down.

Attach the Back Leg & Backrest (C) to the Seat (B) using Bolts(1), Spring Washers(3) and Washers(4) with the Allen Wrench(6).

DO NOT fully tighten the bolts.

Step 4

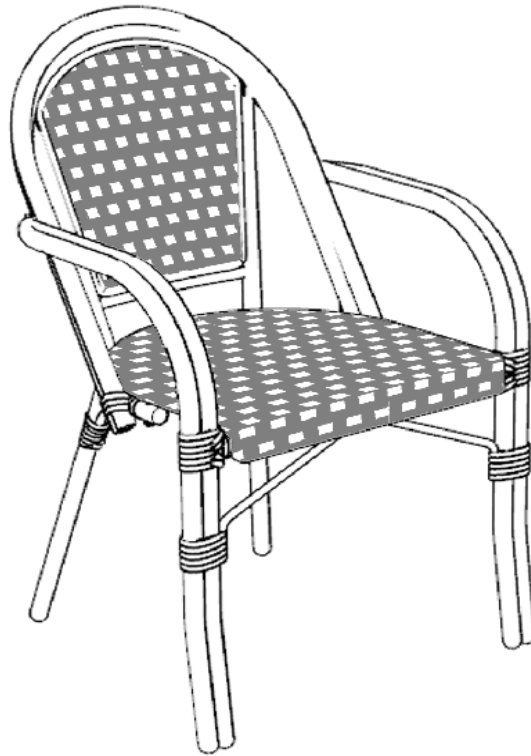

Stand the Chair up.

Place the Chair on a **LEVEL SURFACE**.

Inspect it and make sure all parts are adequately connected.

Gently and carefully, sit on the Chair.

This will help align all parts at all joints.

Then get off the Chair, and in a sequential manner, proceed to tighten all Bolts.

When tightening the Bolts, tighten sequentially.

DO NOT tighten any Bolt fully and then move on to the next one.

This may cause the frame to warp.























If the Chair wobbles after tightening, loosen the Bolts and execute the same process.

If the Chair is not stable, it could lead to damage to the product.

Your Chair is ready for use.

This Chair can only be used on a flat and level surface.

Care & Maintenance

-   ● Prolonged exposure to rain may cause rusting which can stain floors.
 -   ● Do not put hot items directly on the furniture surface.
 -   ● Do not clean furniture with harsh cleansers or polish.
 -   ● To obtain the longest lifespan of your outdoor products, minimizing exposure to direct sunlight is recommended.
 -   ● Children should not climb or jump on the furniture.
 -   ● Do not write on furniture without a padded barrier to protect the surface.
 -   ● To obtain the longest lifespan of your outdoor products, avoid extended and lengthy exposure to rain, snow, and direct sunshine. Whenever possible, cover the product and /or place under patio or awnings.
 -   ● Not for commercial use. For residential use only.
 -   ● Stains may be removed with mild soap solution and damp cloth.
 -   ● Keep away from sources of ignition.
-
-   ● Dust and pick-up spills using a clean, non-colored, lint-free cloth.