

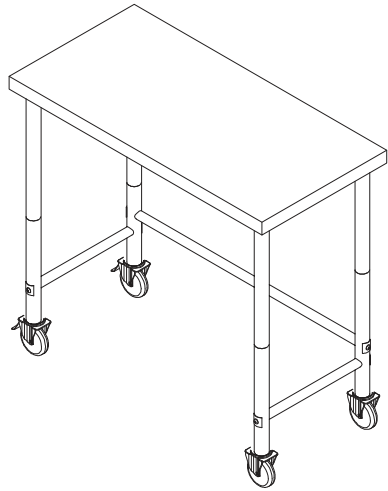

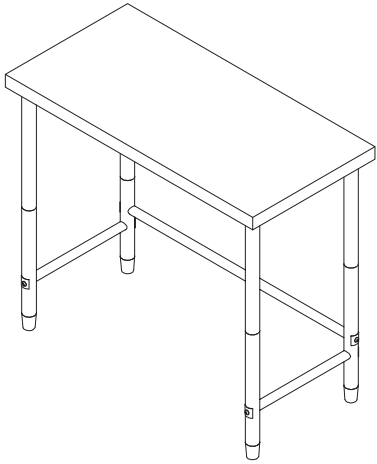

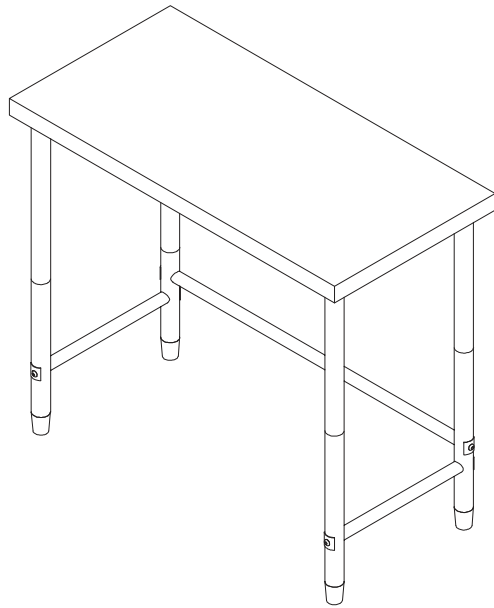









Stainless steel workbench



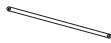



A		X1	G		X2
B		X4	H		X19
C		X1	I		X13
D		X1	J		X4
E		X2	K	 38arcs	X6
F		X1	L		X1
			M	 Wiping cloth	X1
			N		X1



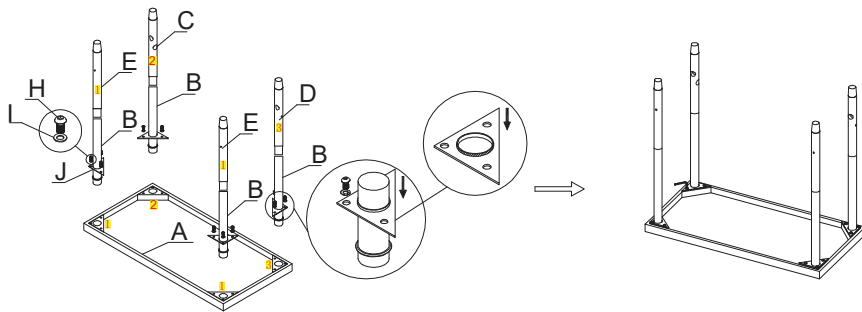



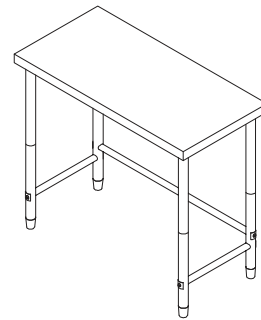
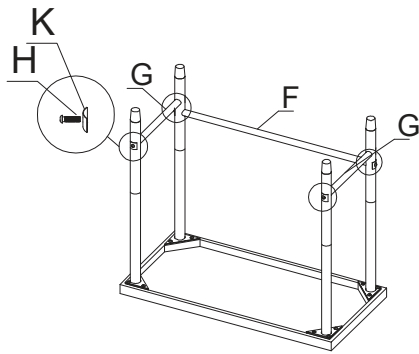

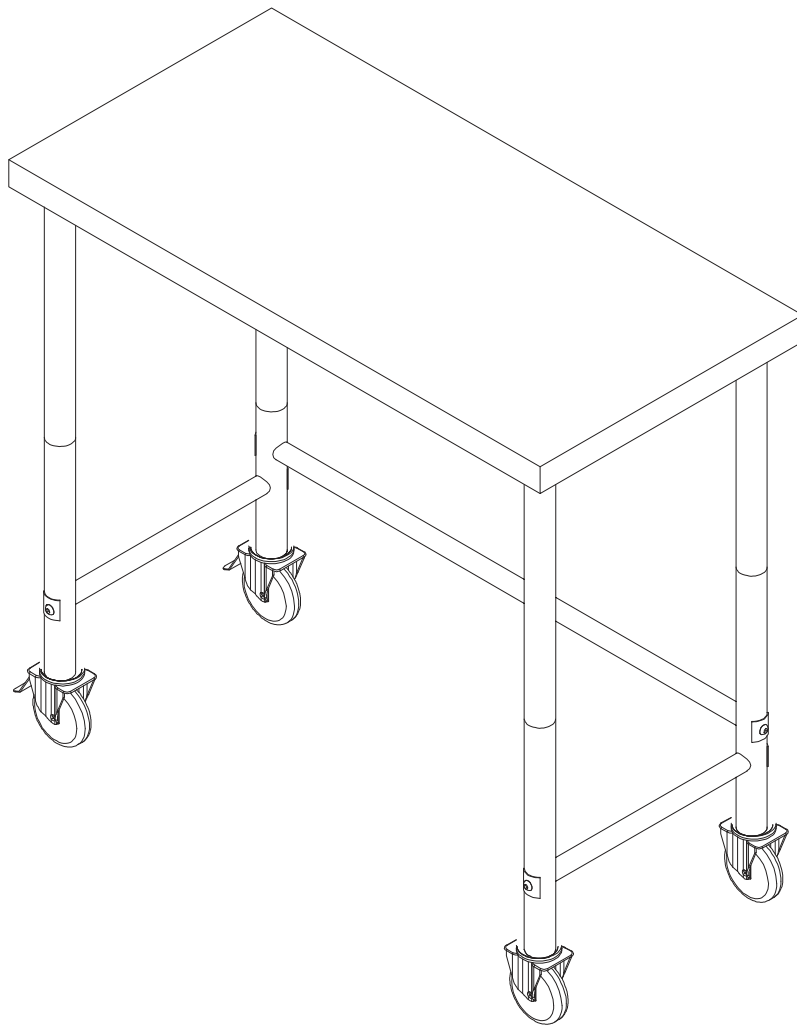







①	A	X1	B	X4	C	X1	D	X1	E	X2	H	X12	I	X12	J	X4
---	---	----	---	----	---	----	---	----	---	----	---	-----	---	-----	---	----











2	G	F	K	H
	X2	X1	X6	X6





A		X1	G		X2	M		X2
B		X4	H		X19	N		X1
C		X1	I		X13	O	 Wiping cloth	X1
D		X1	J		X4	P		X1
E		X2	K	 38arcs	X6			
F		X1	L		X2			

①	A		B		C		D		E		H		I		J	
	X1		X4	X1	X1	X1	X1	X2	X12	X12	X12	X12	X12	X12	X4	

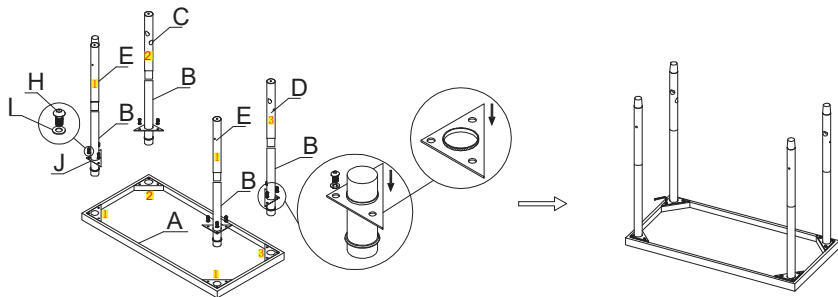

2	G	X2	F	X1	K	X6	H	X6	M	X2	L	X2
---	---	----	---	----	---	----	---	----	---	----	---	----

