

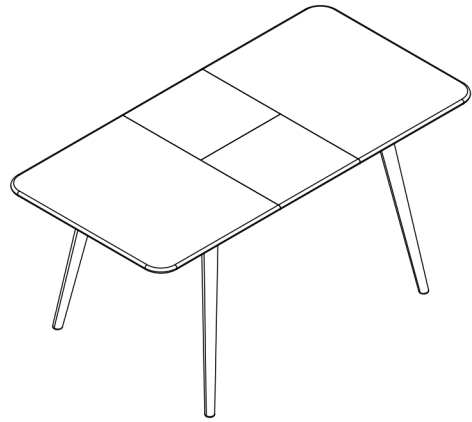

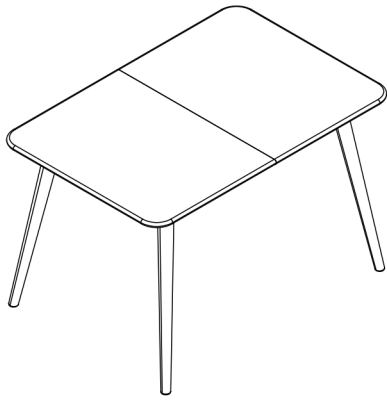

# Assembly Instructions

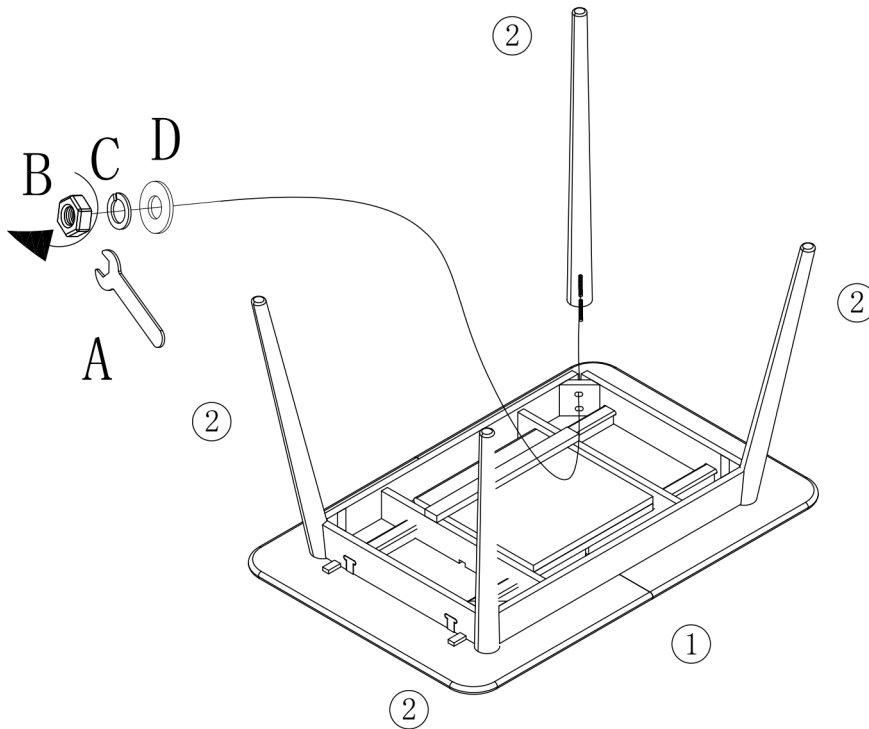

Put the product upside down or sideways, assemble the legs according to the corresponding hole positions, then put the product upright, and then adjust the use of the stretching table according to your needs.



			
A:Wrench =1	B:Nut M8=8	C:Spring washer Φ8=8	D: Flat pad Φ8=8