





ASSEMBLY INSTRUCTION

LOVESEAT

Thank you for purchasing this quality product. Be sure to check all packing material carefully for small parts which may come loose inside the carton during shipment. Identify and count all parts and metal hardware. Compare with the part list to be sure all parts are present, If any part(s) are missing or damage, please contact your local furniture dealer. For efficient and speedy service, please indicate the model number and code letter of part(s) needed.

**Assemble the product on a flat, soft surface such a carpet or cloth to prevent scratching the product finish. Read all instruction and study the drawing carefully before starting the assembly process.

PART LIST			
NO	PART	DECS	QTY
A		SEAT	1PC
B		BACK	1PC

HARDWARE LIST			
NO	HARDWARE	DECS	QTY
1	 5CM*φ0.8	BOLT	4PCS
2	 φ1.8CM	LOCK WASHER	4PCS

*** DON'T TIGHTEN SCREW UNTIL COMPLETELY ASSEMBLED**



STEP 1
Turn the loveseat face down on a smooth, soft surface and unzip the black bottom fabric.

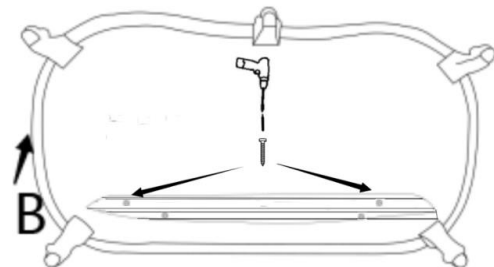

STEP 2
Please screw off the bolts from the wood frame underneath the loveseat with electric drill.

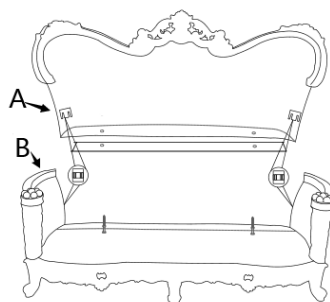

STEP 3
Please Pull Up the Backreset from the SEAT

STEP 4

Please hang up the bracket on the backrest into the bracket on the arm.

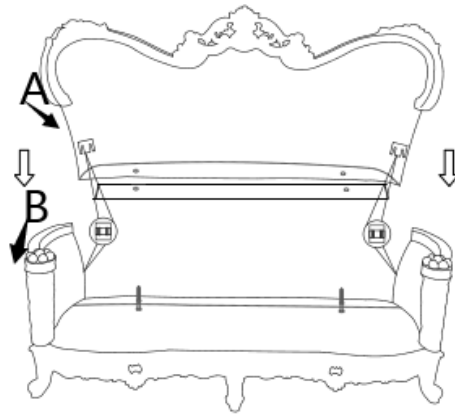

STEP 5

Screw up two bolts into the wood frame underneath the loveseat with electric drill.

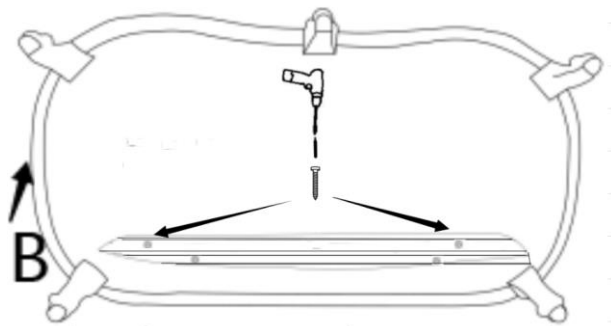

STEP 6

Zipped up the black bottom fabric.

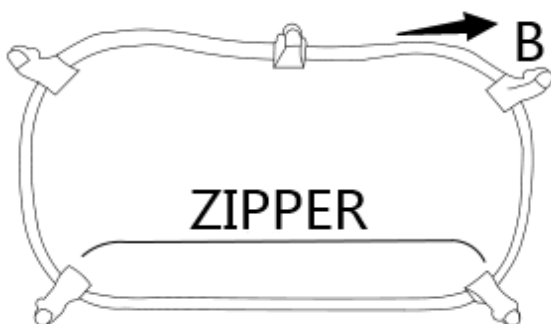

STEP 7

Turn the loveseat over and set up the cushion and pillows.

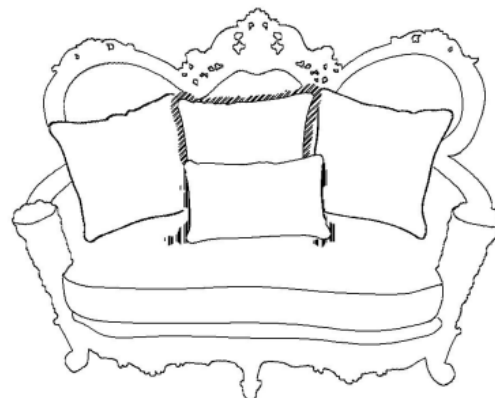

Caution: Over tightening screw or bolts may cause damage.
It is suggested that two people work together for this assembly process.