

Tools Recommended

EN_IMPORTANT, RETAIN FOR FUTURE REFERENCE: READ CAREFULLY.

FR_IMPORTANT: A LIRE ATTENTIVEMENT ET À CONSERVER POUR CONSULTATION ULTÉRIEURE.

ES_IMPORTANTE, LEA Y GUARDE PARA FUTURAS REFERENCIAS.

PT_IMPORTANTE, RETER PARA REFERÊNCIA FUTURA: LEIA ATENTAMENTE.

DE_WICHTIG! SORGFÄLTIG LESEN UND FÜR SPÄTER NACHSCHLAGEN AUFBEWAHREN.

IT_IMPORTANTE! CONSERVARE IL PRESENTE MANUALE PER FUTURO RIFERIMENTO E LEGGERLO ATTENTAMENTE.

ASSEMBLY PREPARATION

Please check local building codes regarding footings, location and other requirements before beginning construction. Study and understand this owner's manual of important information and helpful tips for easier and more enjoyable assembly.

Assembly instructions:

Reviewing all instructions and the appropriate information before you begin, make sure following the step sequence carefully for successful results.

Flooring base:

The site must be prepared so that the base of the shed is level all round and checking with a spirit level is required.

The base can be constructed by treated timber or concrete, in order to stop the moisture getting into the shed, The shed is not designed to be built onto lawn directly. Also the ground will get muddy during rainy days.

If a concrete pad is made, it is important that this slopes towards the edges to prevent water ingress. Time must be allowed for any concrete or cement to dry before building the shed on top.

Bases can also be constructed from bricks, blocks, or mounted on a concrete pad.

The bricks or blocks should be cemented onto firm and level concrete footings and the greenhouse frame drilled and screwed to the base.

Parts and Parts List:

Before you start, separate and identify all the parts and hardware to be sure that you have all the necessary parts for your building (refer to the Parts List Page).

Do not attempt to assemble the building if parts are missing because any building left partially assembled may be seriously damaged by light winds.

Safety must be put in the No. 1 position:

1 Select a dry and calm day for your assembly. Team works (Two or more people) are required during the assembly;

2 Wearing safety gloves, eye protection and long sleeves during the assembly to prevent injury; Pay attention to the sharp edge of some parts;

3 Children and pets are not allowed entering into the construction site;

4 Never concentrate your total weight on the roof of the building. When using a step ladder make sure that it is safety;

Care & Maintenance:

1 Keep the shed clean with soft cloth, use water if necessary;

2 Keep the door tracks clear of dirt and other stuff that prevent them from sliding easily.

3 Clean the snow with necessary tools to make sure it is safe to enter into;

Heavy snow may cause collapse, please make sure safety before entering into.

4 The shed is not made for living but storing stuff.

PRÉPARATION DE L'ASSEMBLAGE

Veillez vérifier les codes du bâtiment locaux concernant les semelles, l'emplacement et d'autres exigences avant de commencer la construction. Étudiez et comprenez dans ce manuel d'information les informations importantes et les conseils utiles pour un montage plus facile et plus agréable.

Instructions de montage :

Avant de commencer, passez en revue toutes les instructions et les informations appropriées. Assurez-vous de suivre attentivement la séquence des étapes pour obtenir des résultats satisfaisants.

Base de plancher :

Le site doit être préparé de sorte que la base du hangar est de niveau sur le tout pourtour, et il faut vérifier avec un niveau à bulle.

La base peut être construite par du bois traité ou du béton, afin d'empêcher l'humidité de pénétrer dans le hangar. **Le hangar n'est pas conçu pour être construit directement sur la pelouse.** Aussi le sol sera boueux pendant les jours de pluie.

Si un tampon en béton est fait, il est important que celle-ci soit inclinée vers les bords pour empêcher l'eau de pénétrer.

Le temps doit être autorisé pour tout béton ou ciment à sécher avant de construire le hangar sur le dessus.

La base peut également être construite à partir de briques, de blocs ou montées sur un socle en béton.

Les briques ou les blocs doivent être cimentés sur des semelles en béton fermes et de niveau et le cadre de serre drillé et vissé à la base.

Pièces et liste des pièces :

Avant de commencer, séparez et identifiez toutes les pièces et le matériel pour vous assurer que vous avez toutes les pièces nécessaires pour votre bâtiment (voir la page Liste des pièces).

N'essayez pas d'assembler le bâtiment si des pièces manquent, car tout bâtiment laissé partiellement assemblé peut être gravement endommagé par de légers vents.

La sécurité doit être votre préoccupation no.1 :

1. Sélectionnez un jour sec et calme pour votre assemblée. Le travail en équipe (deux personnes ou plus) est requis pendant le montage.

2. Porter des gants de protection, des lunettes de protection et des manches longues pendant le montage pour éviter les blessures ; Faites attention au bord tranchant de certaines parties ;

3. Les enfants et les animaux domestiques ne sont pas admis sur le chantier de construction.

4. Ne concentrez jamais votre poids total sur le toit du bâtiment. Lorsque vous utilisez un escabeau, assurez-vous qu'il est en sécurité.

Entretien et maintenance :

1. Gardez la remise propre avec un chiffon doux, utilisez de l'eau si nécessaire ;

2. Gardez les rails de la porte exempts de saleté et autres objets qui les empêchent de glisser facilement.

3. Nettoyer la neige avec les outils nécessaires pour s'assurer qu'il est sans danger d'entrer ; Une neige abondante peut provoquer un effondrement, assurez-vous de la sécurité avant d'entrer.

4. La remise n'est pas faite pour soulever mais pour ranger des objets.

PREPARACIÓN DEL MONTAJE

Antes de comenzar la construcción, consulte los códigos de construcción locales con respecto a las bases, la ubicación y otros requisitos. Estudie y comprenda este manual del propietario ya que contiene información importante y consejos útiles para un montaje más fácil y agradable.

Instrucciones de montaje

Revise todas las instrucciones y la información apropiada antes de comenzar, asegúrese de seguir cuidadosamente la secuencia de pasos para obtener resultados exitosos.

Base de suelo:

El sitio para realizar la instalación debe estar preparado para que la base del cobertizo esté nivelada y se requiera verificar con un nivel de burbuja.

Para evitar que la humedad penetre en el cobertizo, la base se puede construir con madera tratada u hormigón. **El cobertizo no está diseñado para ser construido directamente sobre el césped.** Además, el suelo se enlodará durante los días lluviosos.

Si hace una plataforma de hormigón, es importante que las pendientes inclinen hacia los bordes para evitar la entrada de agua.

Debe esperar para que la plataforma de hormigón, concreto o cemento se seque antes de construir el cobertizo en sobre la plataforma.

Las bases también pueden ser construidas con ladrillos, bloques o montarse sobre una plataforma de hormigón.

Los ladrillos o bloques deben ser cementados sobre las bases de concreto firmes y niveladas y el marco del invernadero debe ser perforado y atornillado a la base.

Lista de Piezas y Accesorios:

Antes de comenzar, separe e identifique todas las piezas y el hardware para asegurarse de que tiene todas las piezas necesarias para su cobertizo (consulte la página de Lista de Piezas).

No intente ensamblar el cobertizo si faltan piezas, porque cualquier cobertizo parcialmente ensamblado puede resultar seriamente dañado por vientos ligeros.

La seguridad se debe enfocar en la posición No. 1.

- 1 Seleccione un día seco y tranquilo para su montaje. Se requiere trabajo en equipo (dos o más personas) durante el montaje.
- 2 Use guantes de seguridad, protección ocular y mangas largas durante el montaje para evitar lesiones; Preste atención al borde afilado de algunas partes.
- 3 Los niños y las mascotas no pueden ingresar al sitio de construcción.
- 4 Nunca concentre su peso total en el techo del edificio. Cuando utilice una escalera de mano, asegúrese de que sea segura.

Cuidado y Mantenimiento

- 1 Mantenga limpio el cobertizo con un paño suave, use agua si es necesario.
- 2 Mantenga los rieles de las puertas libres de suciedad y otras cosas que eviten que se deslicen fácilmente.
- 3 Limpie la nieve con las herramientas necesarias para asegurarse de que sea seguro ingresar; Las fuertes nevadas pueden provocar un colapso, por favor asegúrese de seguridad antes de entrar.
- 4 El cobertizo no está hecho para vivir sino para almacenar cosas.

PREPARAÇÃO DA MONTAGEM

favor, verifique os regulamentos locais de construção no que diz respeito a pavimentos, localização e outros requisitos antes de iniciar a construção. Leia e compreenda este manual do proprietário com informações importantes e dicas úteis para uma montagem mais fácil e mais prazerosa.

Instruções de montagem:

Rever todas as instruções e a informação apropriada antes de começar, certificar-se de seguir cuidadosamente a sequência de passos para obter resultados bem sucedidos.

Base de pavimento:

O local deve ser preparado de modo a que a base do galpão esteja nivelada em toda a volta e é necessário verificar com um nível de espírito.

A base pode ser construída com madeira tratada ou betão, a fim de impedir que a humidade entre no barracão, O barracão não foi concebido para ser construído directamente sobre a relva, e o solo também ficará lamacento durante os dias de chuva.

Se for feita uma almofada de betão, é importante que este desnível se incline para as margens para evitar a entrada de água, deve ser dado tempo para que qualquer betão ou cimento seque antes de construir o barracão no topo.

As bases também podem ser construídas a partir de tijolos, blocos, ou montadas sobre uma almofada de betão.

Os tijolos ou blocos devem ser cimentados em sapatas de betão firmes e niveladas e a armação da estufa deve ser perfurada e aparafusada à base.

Lista de peças:

Antes de começar, separe e identifique todas as peças e equipamentos para ter a certeza de que tem todas as peças necessárias para o seu abrigo (consulte a página Lista de Peças).

Não tente montar o abrigo se faltarem peças porque qualquer abrigo deixado parcialmente montado pode ser seriamente danificado por ventos fracos.

A segurança deve ser colocada na posição nº 1:

- 1 Seleccione um dia seco e calmo para a sua montagem. Trabalhos de equipa (duas ou mais pessoas) são necessários durante a montagem;
- 2 Usar luvas de segurança, protecção dos olhos e mangas compridas durante a montagem para evitar ferimentos; Prestar atenção à aresta afiada de algumas peças;
- 3 Não é permitida a entrada de crianças e animais de estimação no abrigo durante a construção;
- 4 Nunca concentre o seu peso total no telhado do edifício. Ao utilizar uma escada de mão, certifique-se de que é segura;

Cuidados e Manutenção:

- 1 Mantenha o abrigo limpo com um pano macio, use água se necessário;
- 2 Mantenha os caminhos das portas livres de sujidade e outras coisas que os impeçam de deslizar facilmente.
- 3 Limpar a neve com as ferramentas necessárias para garantir que é seguro entrar; A neve pesada pode causar desmoronamento, por favor, garantir a segurança antes de entrar.
- 4 O abrigo não é feito para viver, mas para armazenar coisas.

VORBEREITUNG FÜR DIE MONTAGE

Vor Beginn der Bauarbeiten überprüfen Sie bitte die örtlichen Bauvorschriften in Bezug auf Fußböden, Standort und andere Anforderungen. Lesen und verstehen Sie diese Bedienungsanleitung mit wichtigen Informationen und hilfreichen Tipps für eine einfachere und angenehmere Montage.

Montageanweisung:

Überprüfen Sie alle Anweisungen und die entsprechenden Informationen, bevor Sie beginnen. Stellen Sie bitte sicher, dass Sie die Schrittsequenz sorgfältig befolgen, um erfolgreiche Ergebnisse zu erzielen.

Bodenbelag:

Der Standort muss so vorbereitet werden, dass der Boden des Schuppens rundum eben ist, und eine Überprüfung mit einer Wasserwaage ist erforderlich.

Der Sockel kann aus behandeltem Holz oder Beton hergestellt werden, um das Eindringen von Feuchtigkeit in den Schuppen zu verhindern. Der Schuppen ist nicht dafür vorgesehen, direkt auf Rasenflächen gebaut zu werden. Auch der Boden wird an Regentagen matschig.

Wenn eine Betonplatte hergestellt wird, ist es wichtig, dass diese zu den Rändern hin geneigt ist, um das Eindringen von Wasser zu verhindern.

Vor dem Bau des Schuppens muss Zeit zum Trocknen von Beton oder Zement eingeplant werden.

Die Fundamente können auch aus Ziegelsteinen oder Blöcken gebaut oder auf eine Betonplatte montiert werden.

Die Ziegel oder Blöcke sollten auf feste und ebene Betonfundamente zementiert und der Gewächshausrahmen gebohrt und mit dem Sockel verschraubt werden.

Teile und Teileliste:

Bevor Sie beginnen, trennen und identifizieren Sie alle Teile und Hardware, um sicherzustellen, dass Sie alle erforderlichen Teile für Ihr Gebäude haben (siehe Seite Teileliste).

Versuchen Sie nicht, das Gebäude zusammenzubauen, wenn Teile fehlen, da ein teilweise zusammengebautes Gebäude durch leichten Wind ernsthaft beschädigt werden kann.

Achten Sie erst auf die Sicherheit :

1 Wählen Sie einen trockenen und ruhigen Tag für Ihre Montage aus. Teamarbeiten (Zwei oder mehr Personen) sind während der Montage erforderlich;

2 Tragen Sie die Schutzhandschuhen, Augenschutz und langen Ärmeln bei der Montage zur Vermeidung von Verletzungen; Achten Sie auf die scharfe Kante für einige Teile;

3 Die Kinder und Haustiere dürfen nicht auf die Baustelle betreten;

4 Konzentrieren Sie niemals Ihr Gesamtgewicht auf das Dach des Gebäudes. Bei Verwendung einer Trittleiter sollen Sie die Sicherheit gewährleisten.

Pflege und Wartung:

1 Halten Sie den Schuppen mit einem weichen Tuch sauber, verwenden Sie das Wasser wenn nötig;

2 Halten Sie die Türschiene von Schmutz und anderen Gegenständen fern, damit sie nicht leicht verrutschen können.

3 Reinigen Sie den Schnee mit den notwendigen Werkzeugen, um sicherzugehen, dass Sie sicher betreten können; Starker Schneefall kann zum Einsturz führen, bitte gewährleisten Sie die Sicherheit vor dem Betreten .

4 Der Schuppen ist nicht zum Wohnen gemacht, sondern zum Aufbewahren von Sachen.

MONTAGGIO

Prima di iniziare, si prega di verificare i regolamenti edilizi locali relativi alle fondamenta, alla posizione e ad altri requisiti. Si prega di studiare e comprendere questo manuale di informazioni importanti e suggerimenti utili per un assemblaggio più semplice.

Istruzioni di assemblaggio:

Si prega di visionare tutte le istruzioni e le informazioni prima di iniziare, accertandosi di seguire attentamente la sequenza di passaggi.

Fondazione del pavimento:

L'area deve essere preparata in modo che la base del capannone sia livellata tutt'intorno ed è necessario verificare con una livella a bolla d'aria.

Le fondamenta possono essere costruite in legno trattato o cemento, per impedire che l'umidità penetri nel capannone. **Il capannone non è progettato per essere costruito direttamente sul prato.** Il terreno diventerà fangoso durante i giorni di pioggia.

Se viene posizionato su un blocco di cemento, è importante che esso sia inclinato ai bordi per evitare l'ingresso di acqua.

È necessario attendere che il calcestruzzo o il cemento si asciughino prima di costruirvi sopra il capannone.

Le fondamenta possono anche essere costruite da mattoni, blocchi o direttamente da un blocco di cemento.

I mattoni devono essere cementati su basi di cemento solide e livellate in piano, e il telaio del capannone va forato e avvitato alla base.

Parti e lista delle parti:

Prima di iniziare, separare e identificare tutte le parti e l'hardware per essere sicuri di disporre di tutte le parti necessarie per la costruzione (fare riferimento alla pagina della Lista delle Parti).

Non tentare di montare la costruzione se mancano parti perché qualsiasi costruzione lasciata parzialmente assemblata può essere seriamente danneggiata da venti leggeri.

La sicurezza deve venire prima di tutto:

- 1 Scegli un giorno asciutto e calmo per il tuo assemblaggio. Il lavoro di gruppo (due o più persone) è richiesto durante l'assemblaggio;
- 2 Indossare guanti di sicurezza, occhiali protettivi e maniche lunghe durante l'assemblaggio per evitare lesioni. Prestare attenzione al bordo tagliente di alcune parti;
- 3 Ai bambini e agli animali domestici non è consentito entrare nel cantiere;
- 4 Non concentrare mai il peso totale sul tetto dell'edificio. Quando si utilizza una scala a pioli, assicurarsi che sia sicura;

Manutenzione:

- 1 Tenere il capanno pulito con un panno morbido, usare acqua se necessario;
- 2 Tenere i binari della porta liberi da sporcizia e altre cose che impediscano loro di scivolare facilmente.
- 3 Pulisci la neve con gli strumenti necessari per assicurarti che sia sicuro entrare; La neve pesante può causare il collasso, controlla che sia sicuro prima di entrare.
- 4 Il capanno non è ideato come zona abitativa, ma solo come magazzino.

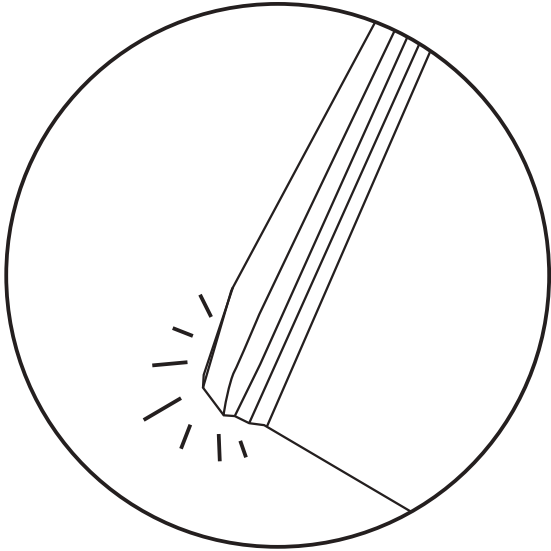

EN_NOTICE: If there is slight bending on the corners

FR_AVIS : En cas de légère courbure des angles

ES_NOTA: Si hay una ligera flexión en las esquinas

PT_AVISO: Se houver uma ligeira dobragem nas esquinas

DE_HINWEIS: Wenn die Ecken leicht gebogen sind

IT_AVVISO: Qualora ci fosse una leggera flessione sugli angoli

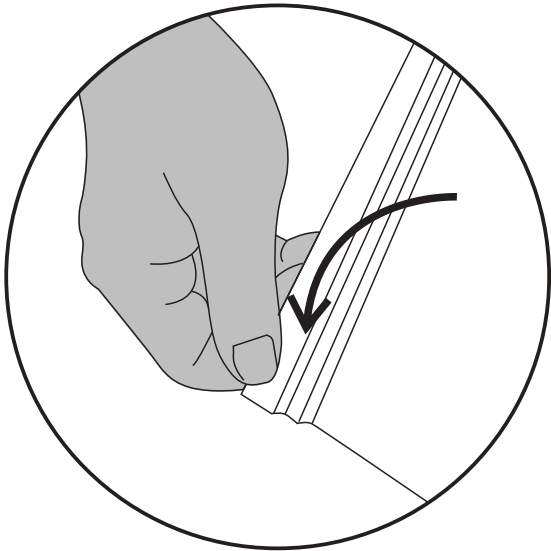

EN_1. Pls wear gloves and stretch the corners slightly until they are flat

FR_1. Veuillez porter des gants et exercer une légère torsion sur les bords jusqu'à ce qu'ils soient plats

ES_1. Por favor, use guantes y estire las esquinas ligeramente hasta que queden planas

PT_1. Utilize uma luva e estique ligeiramente os cantos até que estejam normais

DE_1. Bitte tragen Sie Handschuhe und dehnen Sie die Ecken leicht, bis sie flach sind

IT_1. Si prega di indossare dei guanti e di allungare leggermente gli angoli fino a quando non si sono appiattiti

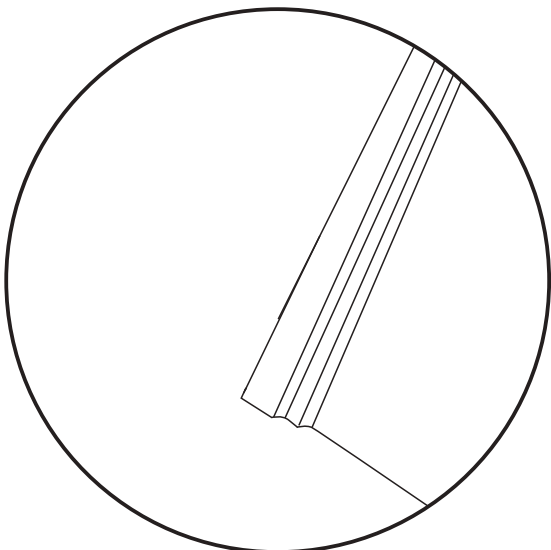

EN_2. Then the sheets will be normal and there is no effect on the assembling

FR_2. Les feuilles deviennent alors normales ; sans incidence sur l'assemblage.



















ES_2. Entonces las hojas serán normales y no hay ninguna influencia sobre el ensamblaje



PT_2. Em seguida, os painéis estarão normais e não há efeito sobre a montagem





DE_2. Dann sind die Platten normal und es gibt keine Auswirkungen auf den Zusammenbau



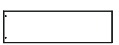









IT_2. Quindi le lastre torneranno normali e non vi sarà alcun effetto sull'assemblaggio









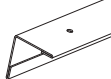
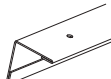
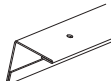
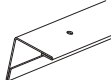

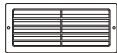
PACKING DETAILS: TOTAL 4 BOXES







BOX 1/4	NO.	PART	Qty.
	P2		2
	P2A		2
	P4A		2
	P1A		2
	P4B		3
	25L		1
	25R		1
	D1		1
	D2		1
	20		4
	27		2
	21L1		1
	21L2		1
	21R1		1
	21R2		1
	6		1
	7		1
	8		1

BOX 2/4	NO.	PART	Qty.
	P3		18
	12		1
	12L		1
	12R		1



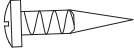

BOX 3/4	NO.	PART	Qty.
	P5		4
	P6		4
	P5B		4
	P6B		4

BOX 4/4	NO.	PART	Qty.
	1		2
	2		2
	4L		1
	4R		1
	3L		1
	3R		1
	5		1
	13		1
	14		1
	9		2
	11		2
	10L		1
	10R		1
	22		2
	23		2
	24L		1
	24R		1

BOX 4/4	NO.	PART	Qty.
	GF		2
	GC		4
	GB		2
	GD		4
	G2		4
	B1		4
	B2		2
	B3		2
	15		2
	16		2
	17		4



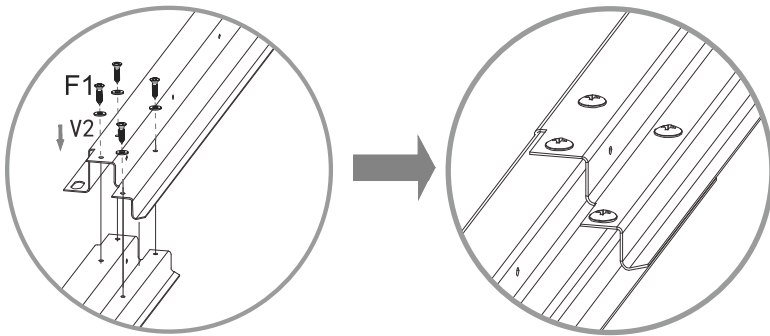
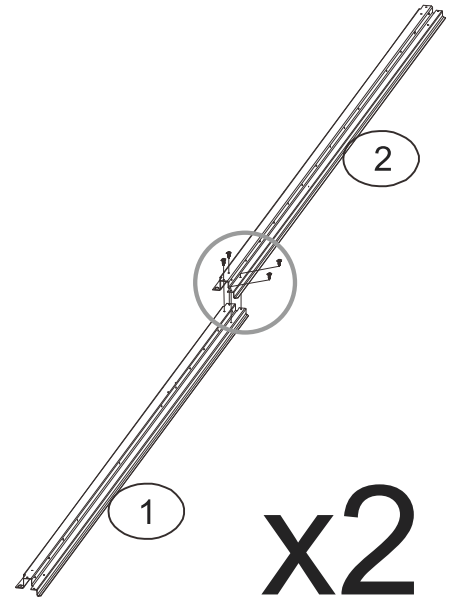

BOX 4/4	NO.	PART	Qty.
HARDWARE			
	F1		460
	F2		70
	F3		8
	V2		435
	S1		260
	K		1
			1

01

Teile / Parts	Nr. / No.	Stk. / Qty.
	1	2
	2	2
	F1	8
	V2	8





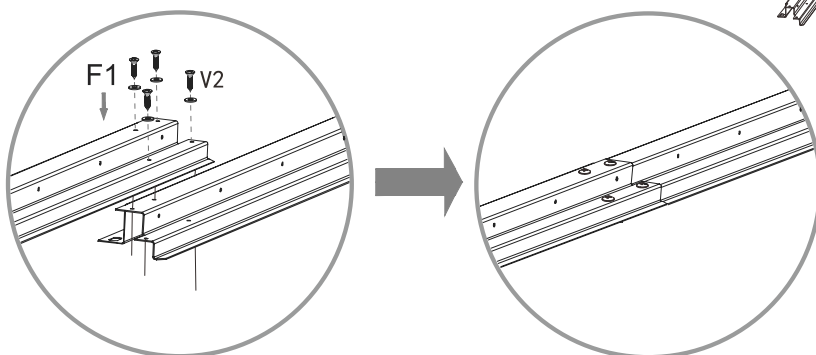
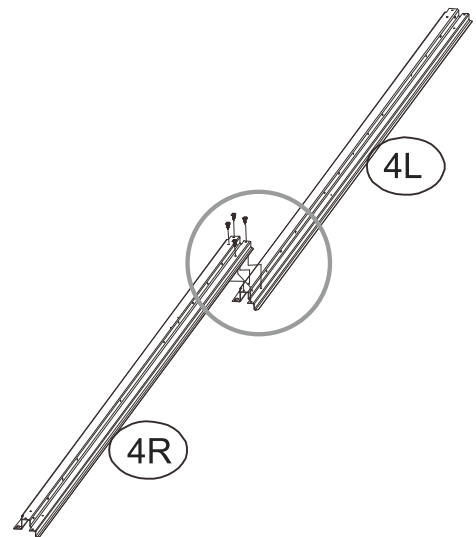

02

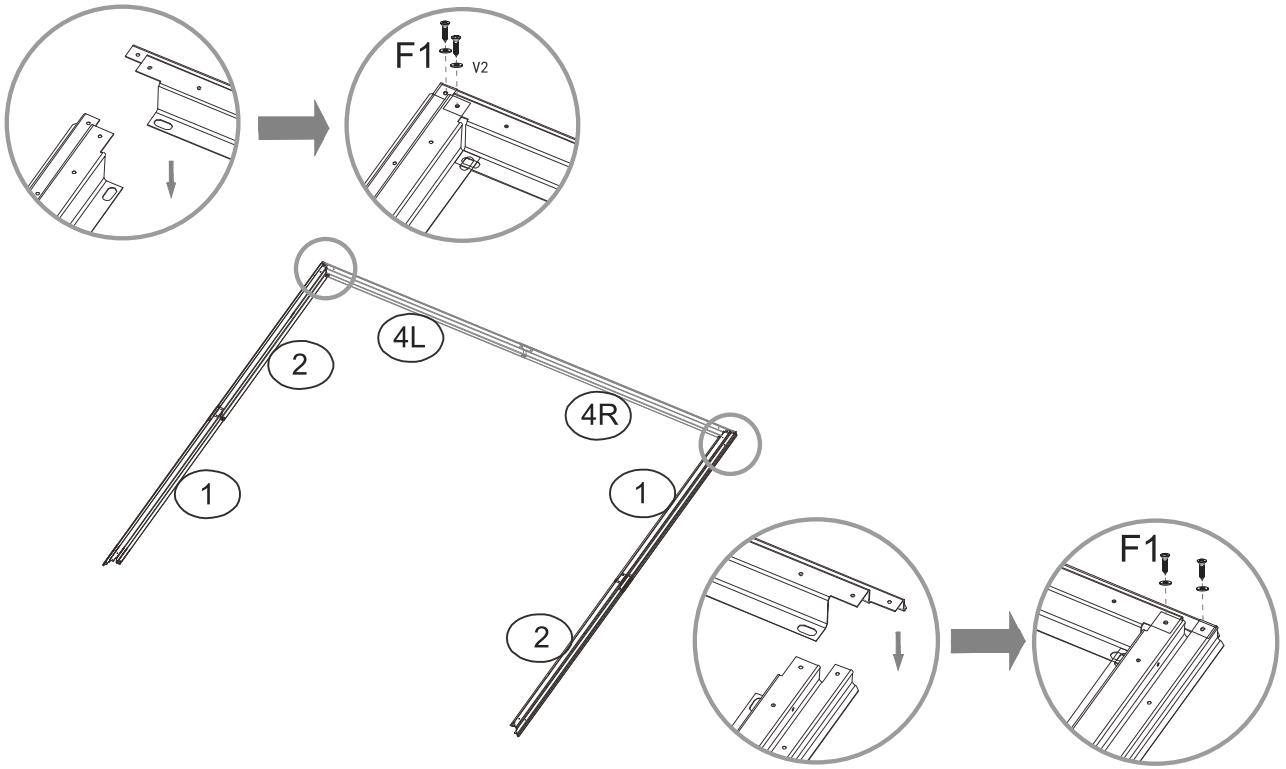

Teile / Parts	Nr. / No.	Stk. / Qty.
	4L	1
	4R	1
	F1	4
	V2	4





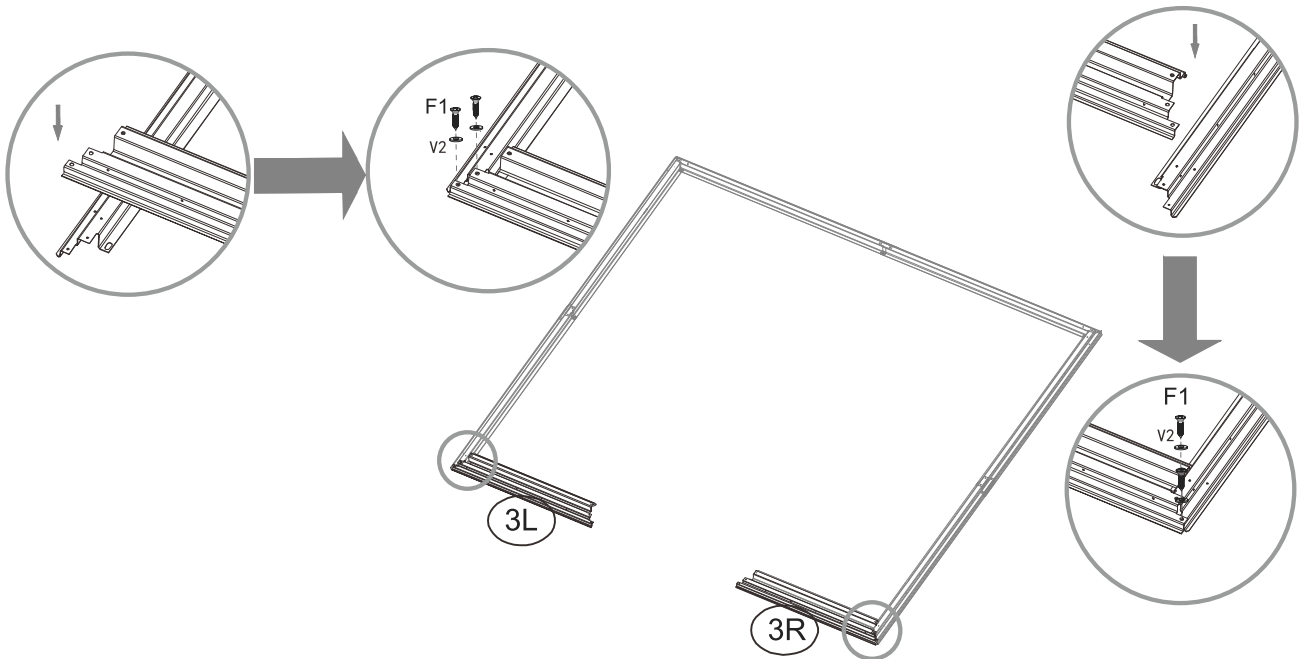



Teile / Parts	Nr. / No.	Stk. / Qty.
	3L	1
	3R	1
	F1	4
	V2	4

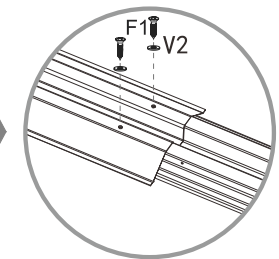
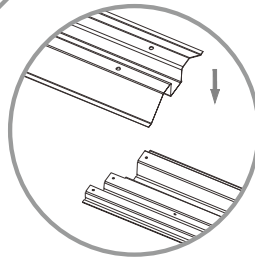
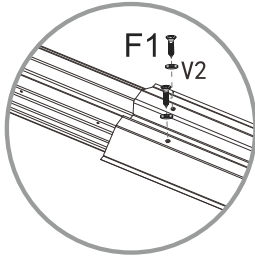
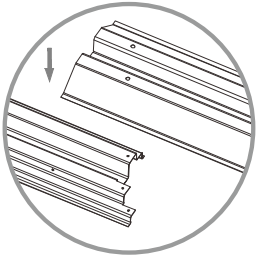
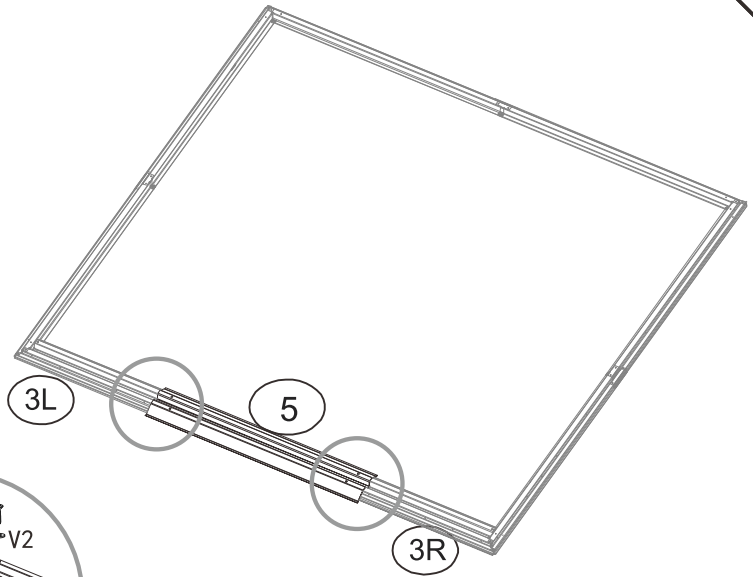





Teile / Parts	Nr. / No.	Stk. / Qty.
	5	1
	F1	4
	V2	4

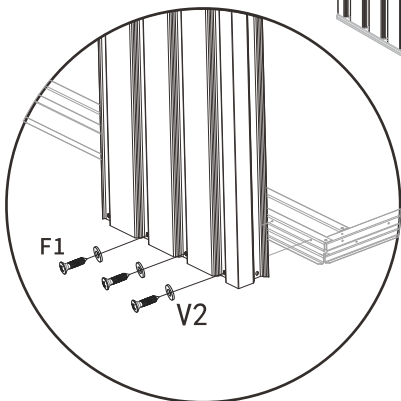
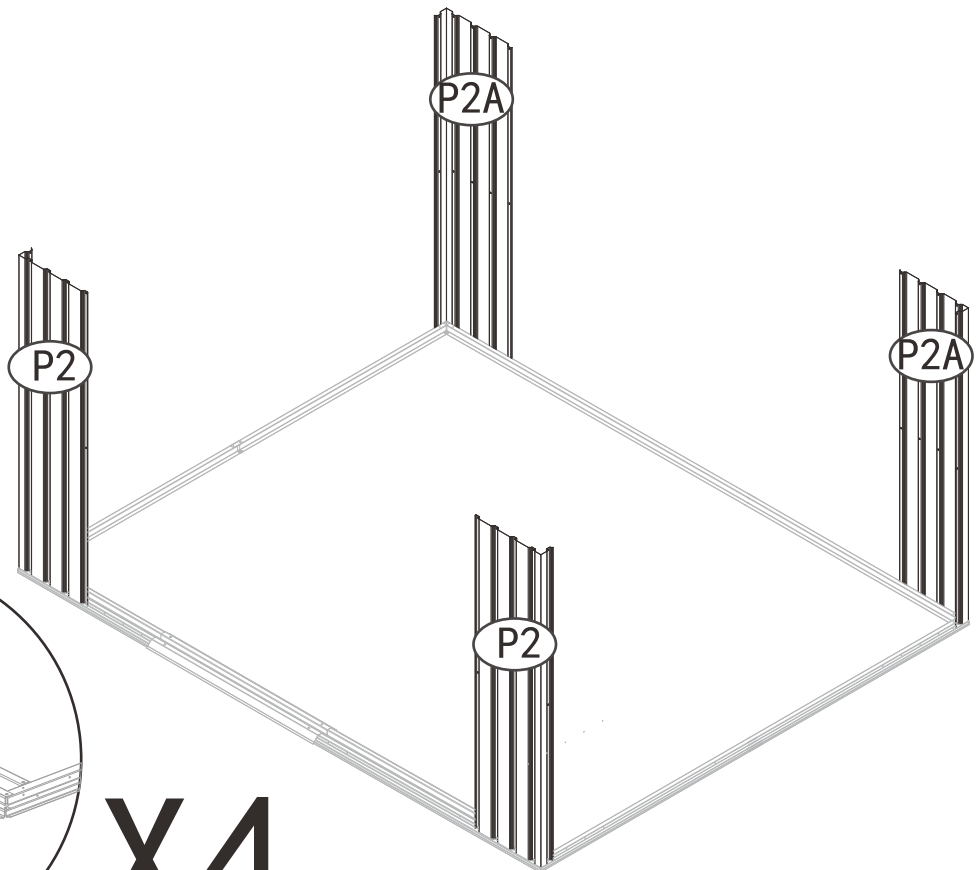





Teile / Parts	Nr. / No.	Stk. / Qty.
	P2	2
	P2A	2
	F1	12
	V2	12



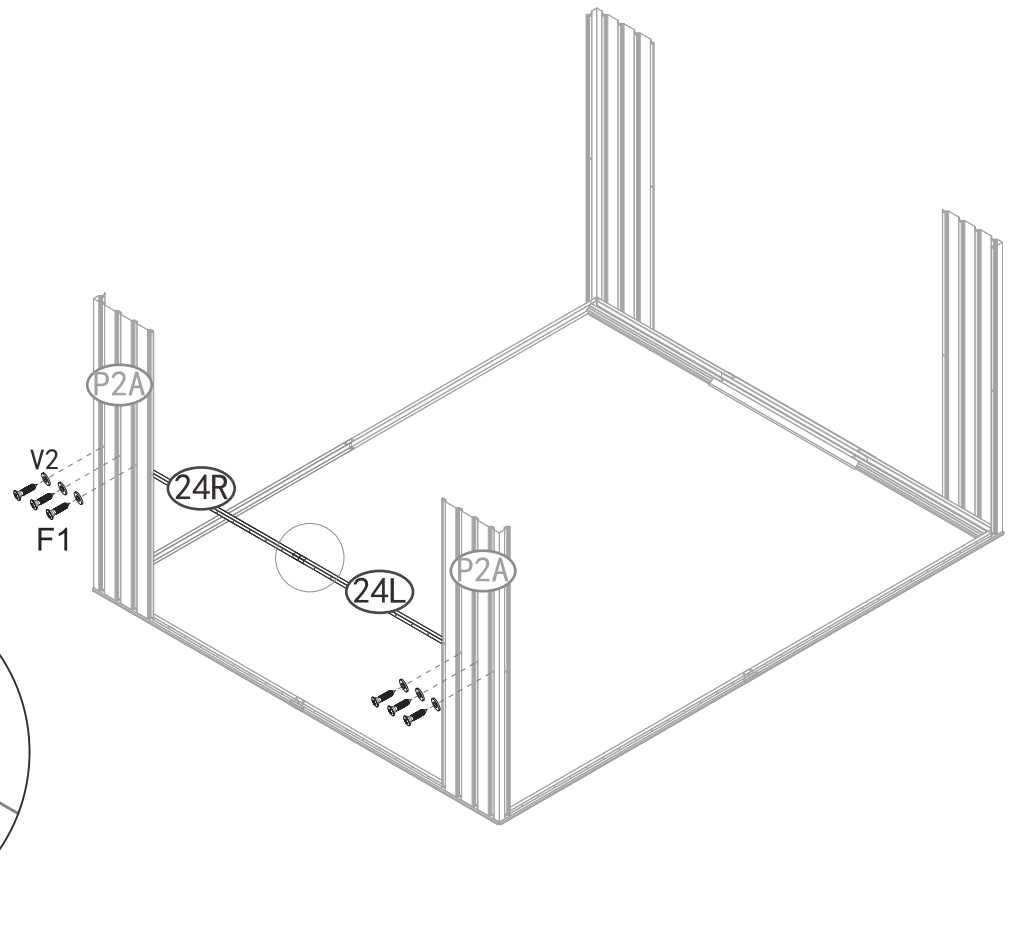



X4

Teile / Parts	Nr. / No.	Stk. / Qty.
	24L	1
	24R	1
	F1	7
	V2	7

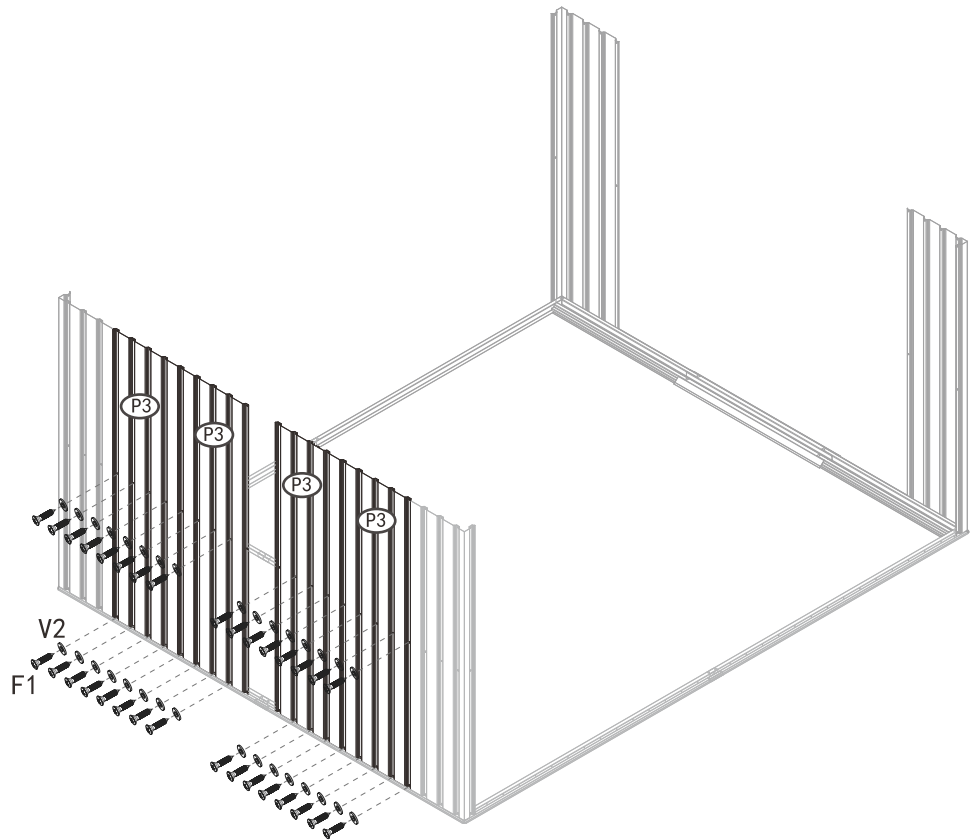





Teile / Parts	Nr. / No.	Stk. / Qty.
	P3	4
	F1	32
	V2	32

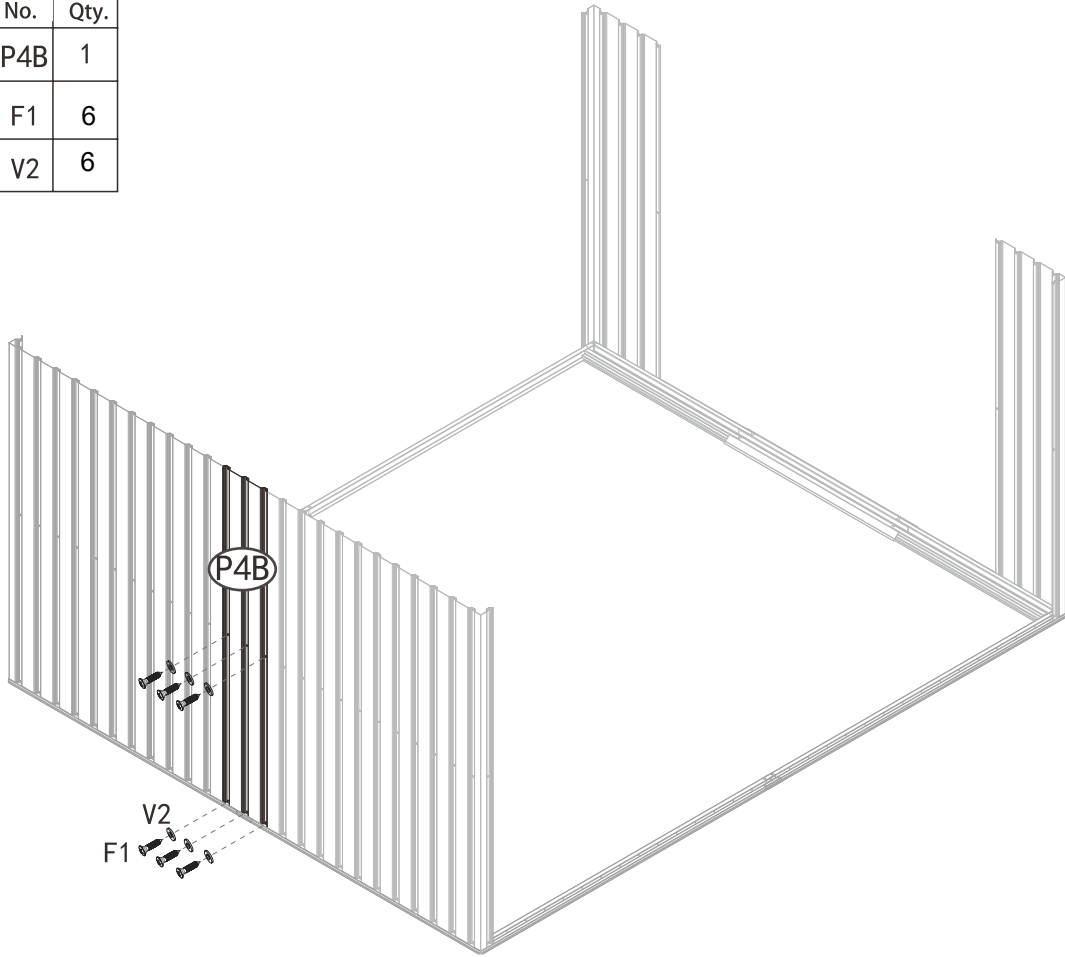





Teile / Parts	Nr. / No.	Stk. / Qty.
	P4B	1
	F1	6
	V2	6

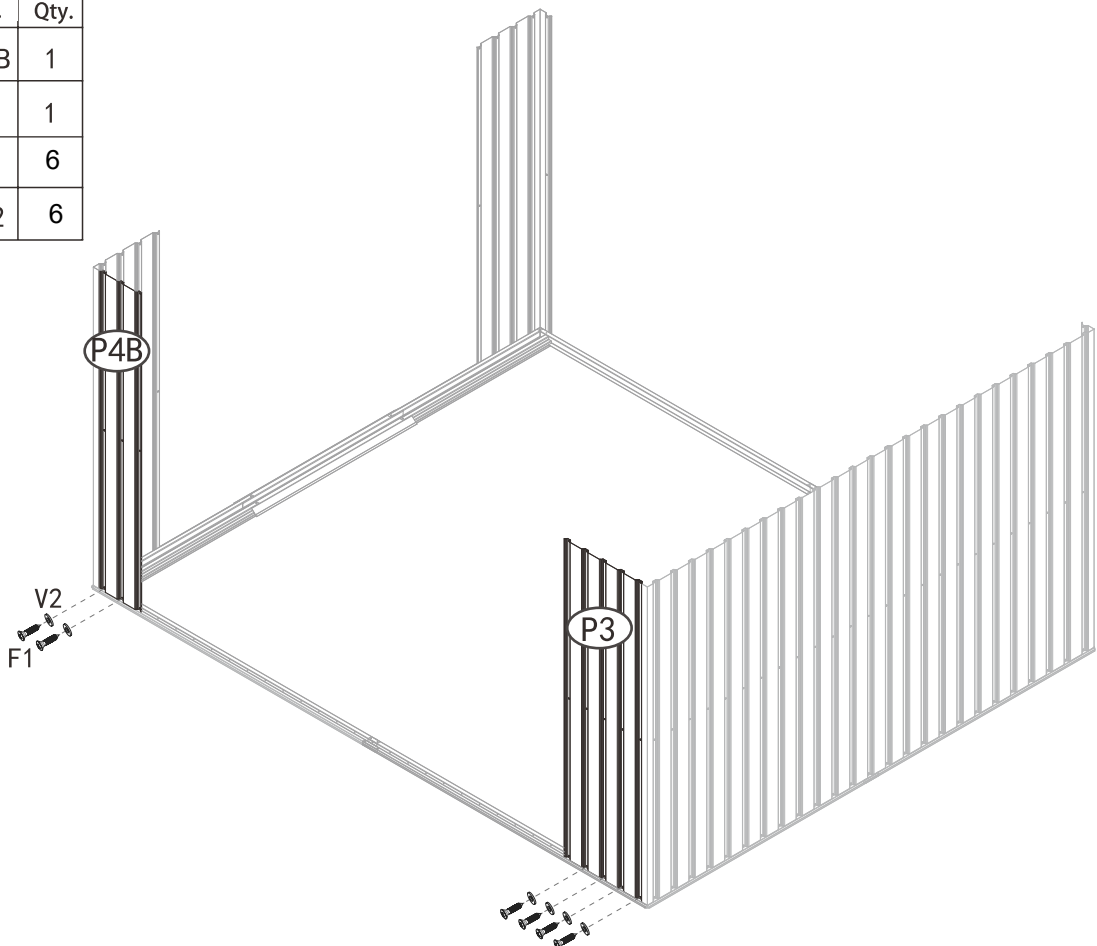



Teile / Parts	Nr. / No.	Stk. / Qty.
	P4B	1
	P3	1
	F1	6
	V2	6



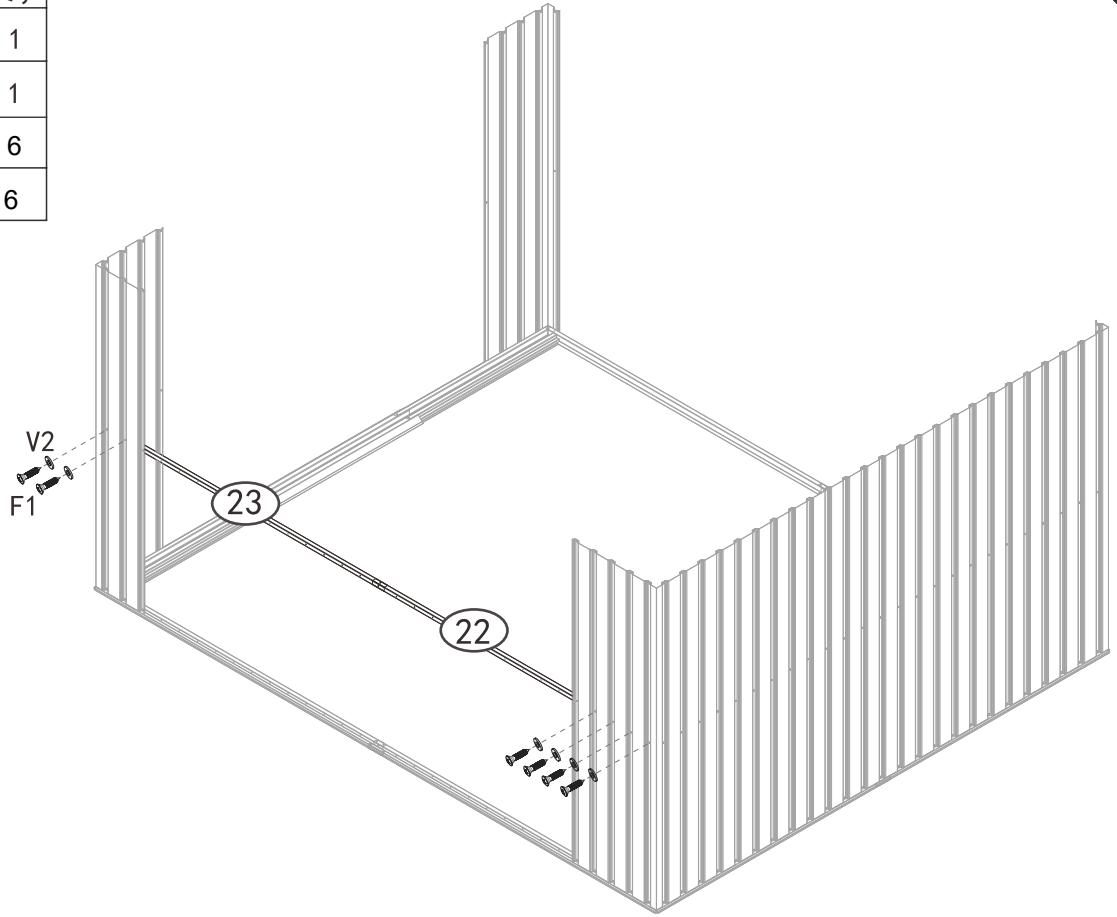



Teile / Parts	Nr. / No.	Stk. / Qty.
	22	1
	23	1
	F1	6
	V2	6

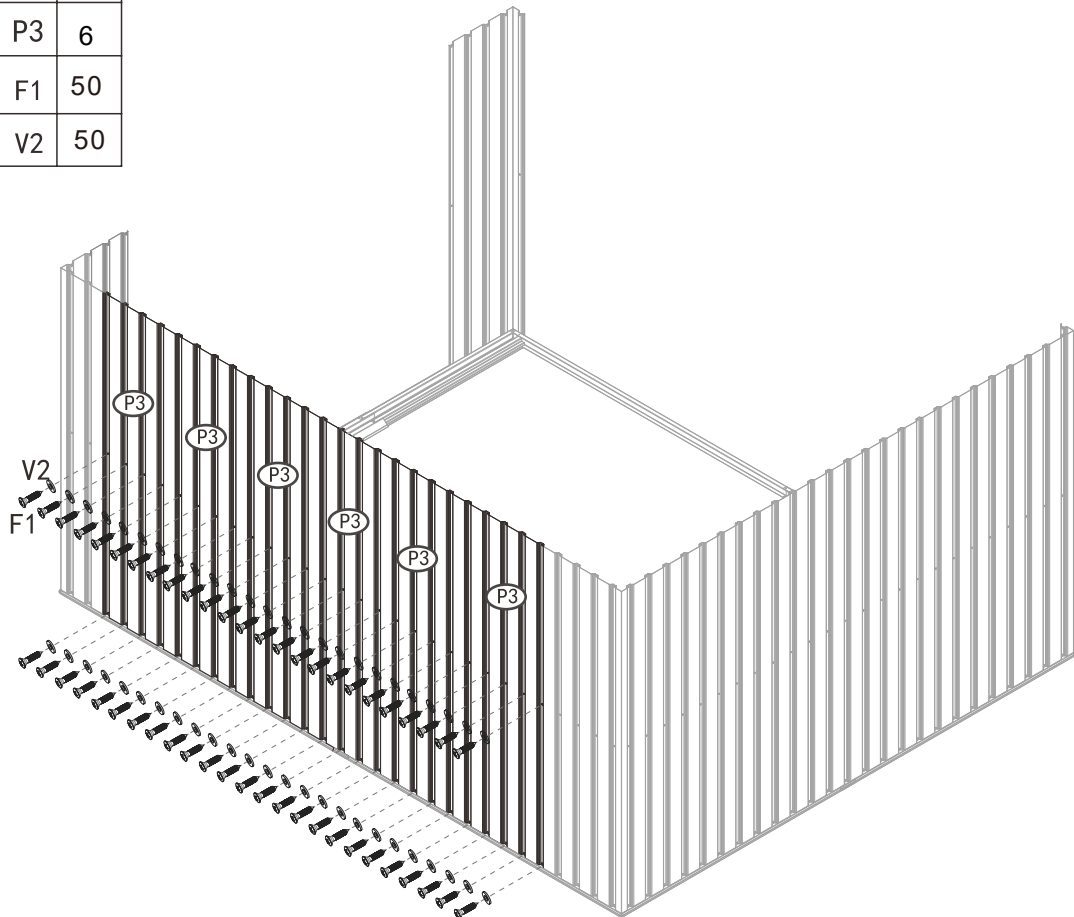





Teile / Parts	Nr. / No.	Stk. / Qty.
	P3	6
	F1	50
	V2	50

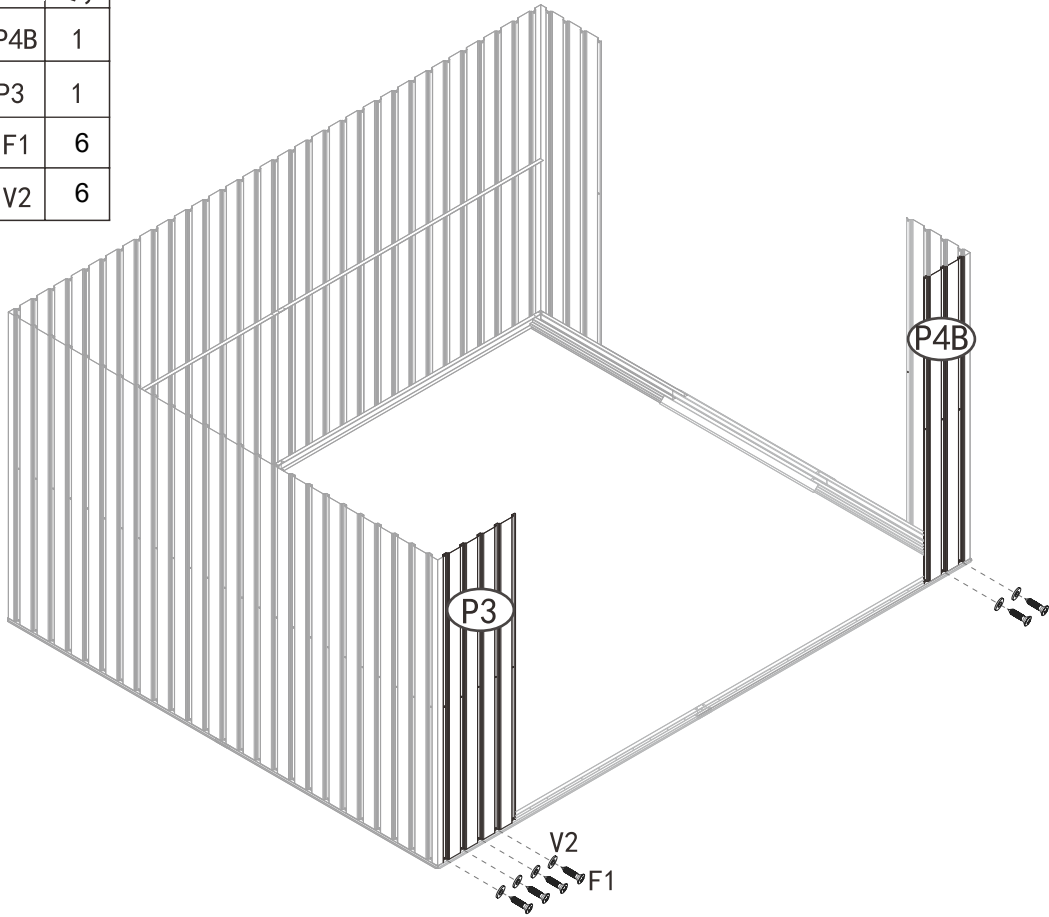



Teile / Parts	Nr. / No.	Stk. / Qty.
	P4B	1
	P3	1
	F1	6
	V2	6



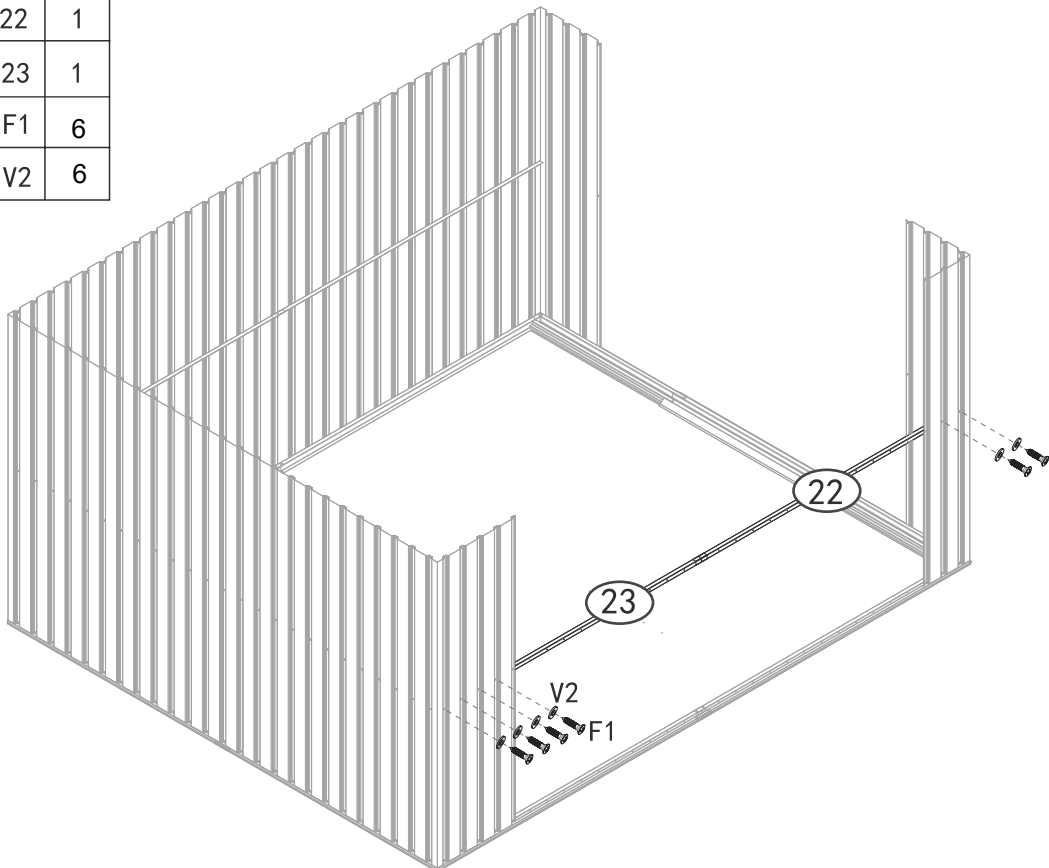



Teile / Parts	Nr. / No.	Stk. / Qty.
	22	1
	23	1
	F1	6
	V2	6

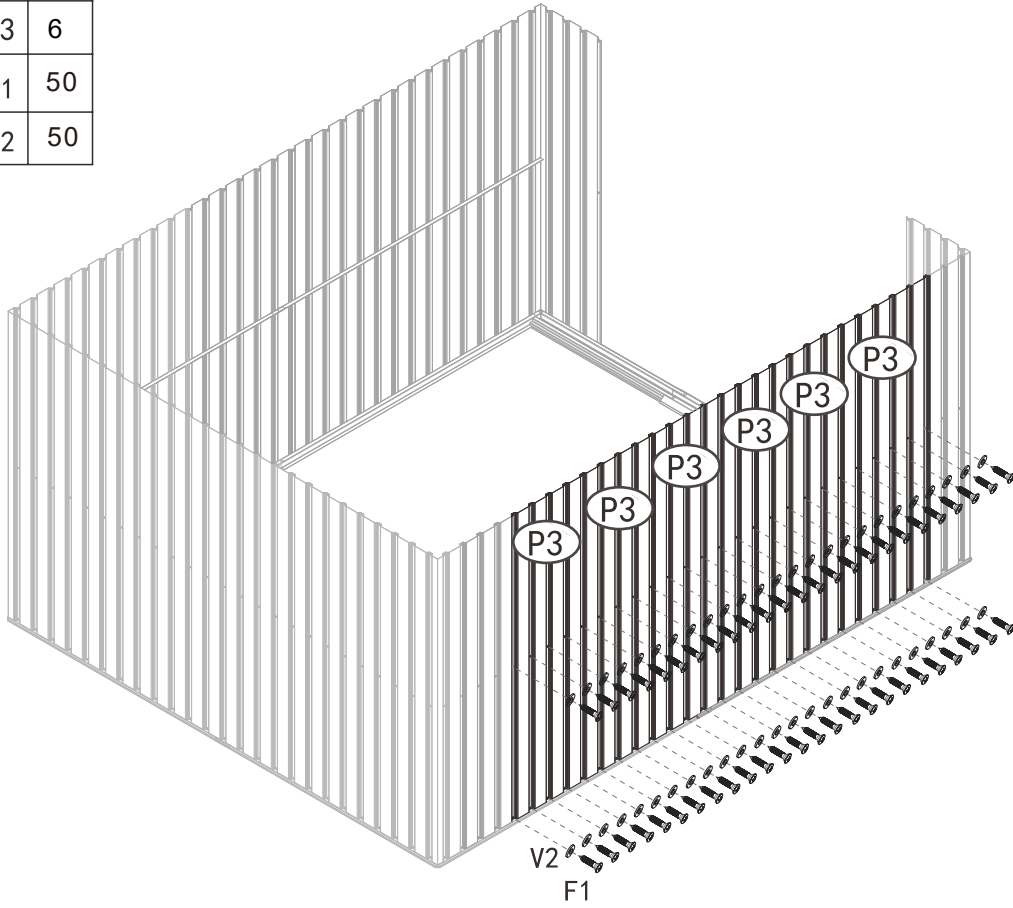





Teile / Parts	Nr. / No.	Stk. / Qty.
	P3	6
	F1	50
	V2	50

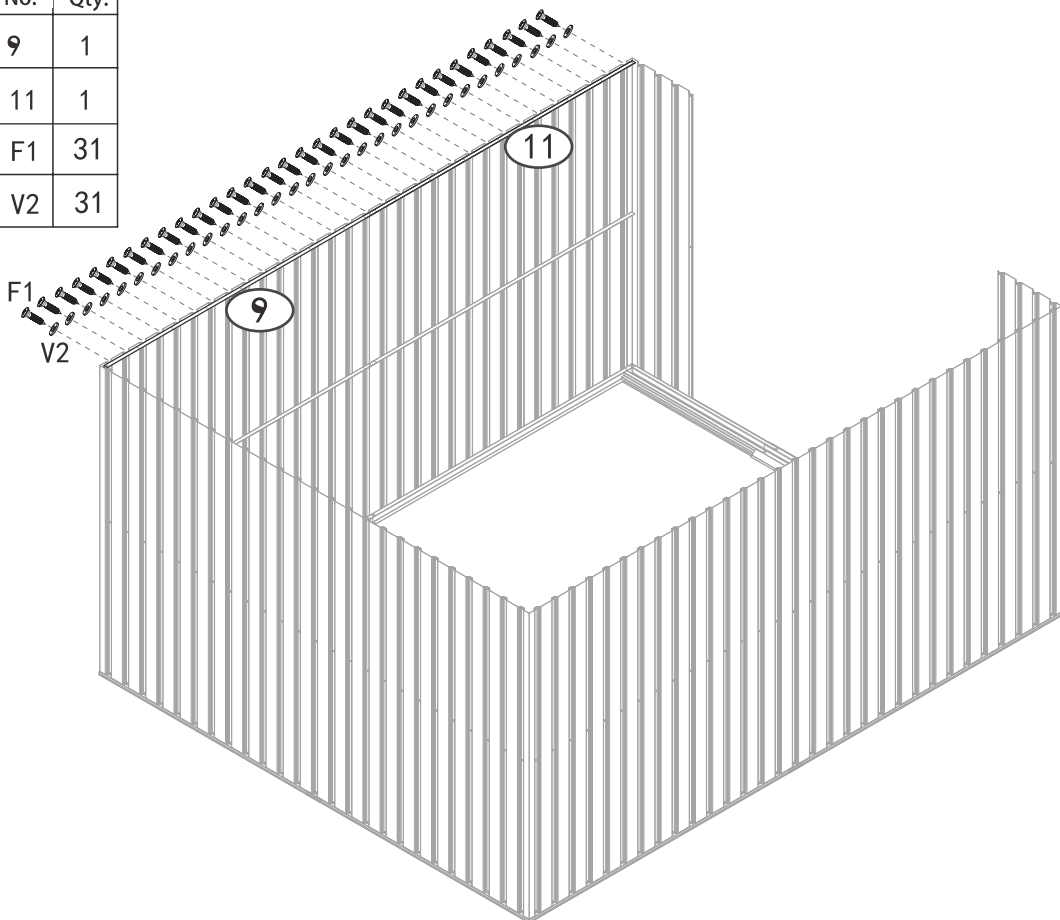





Teile / Parts	Nr. / No.	Stk. / Qty.
	9	1
	11	1
	F1	31
	V2	31

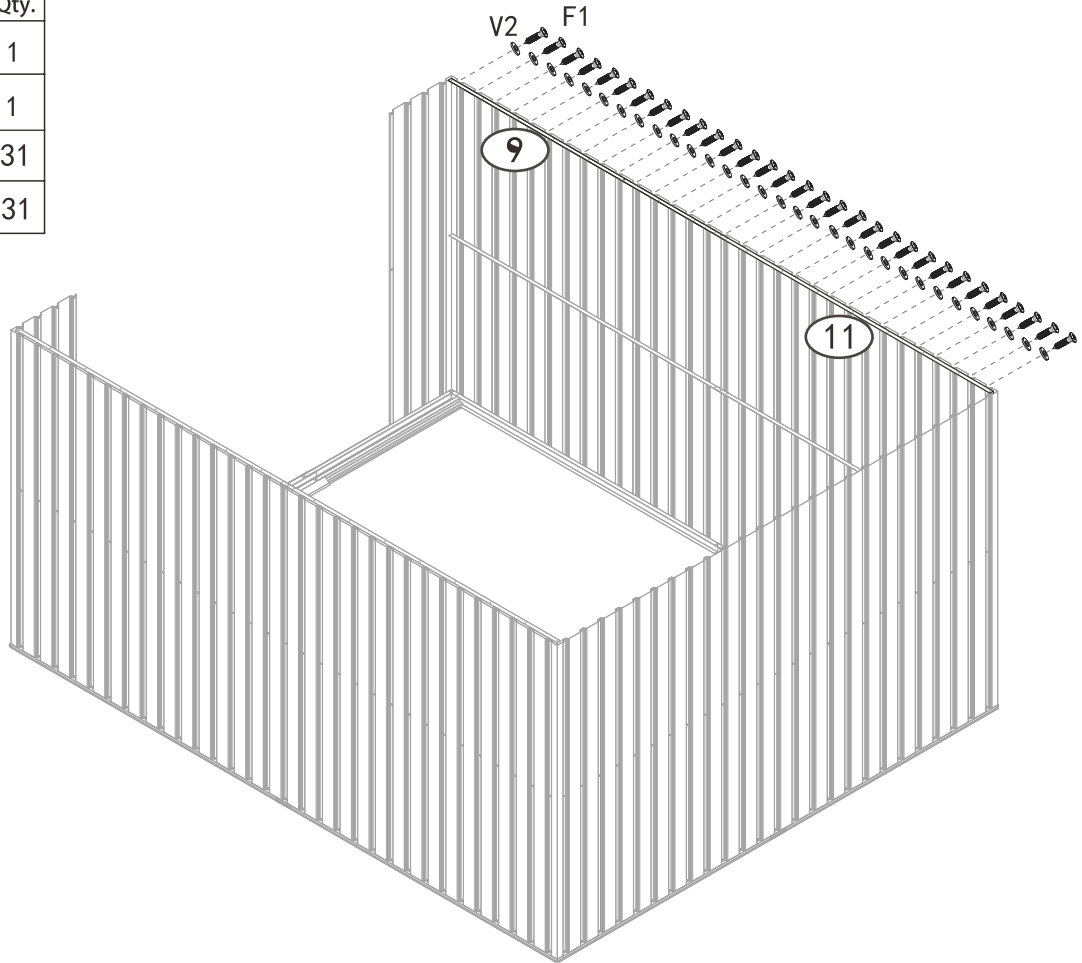



Teile / Parts	Nr. / No.	Stk. / Qty.
	9	1
	11	1
	F1	31
	V2	31



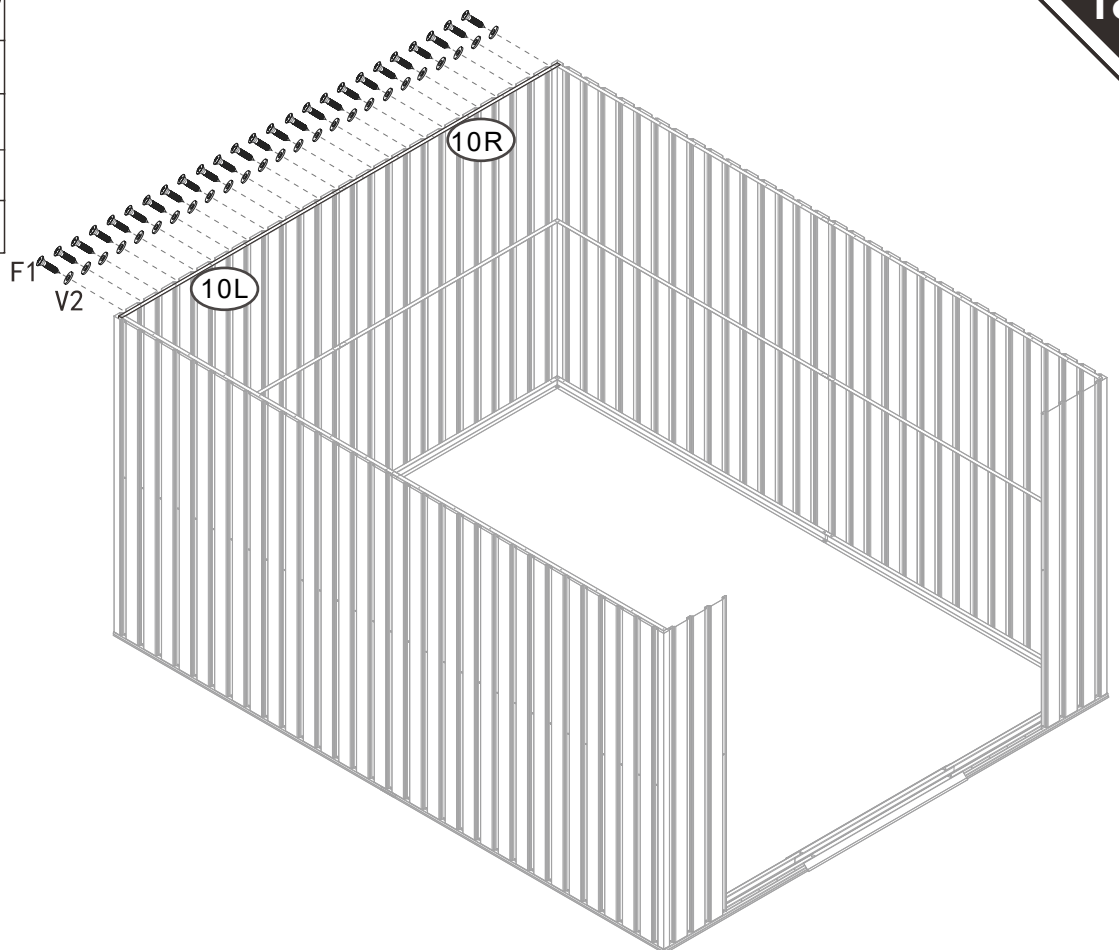



Teile / Parts	Nr. / No.	Stk. / Qty.
	10L	1
	10R	1
	F1	25
	V2	25

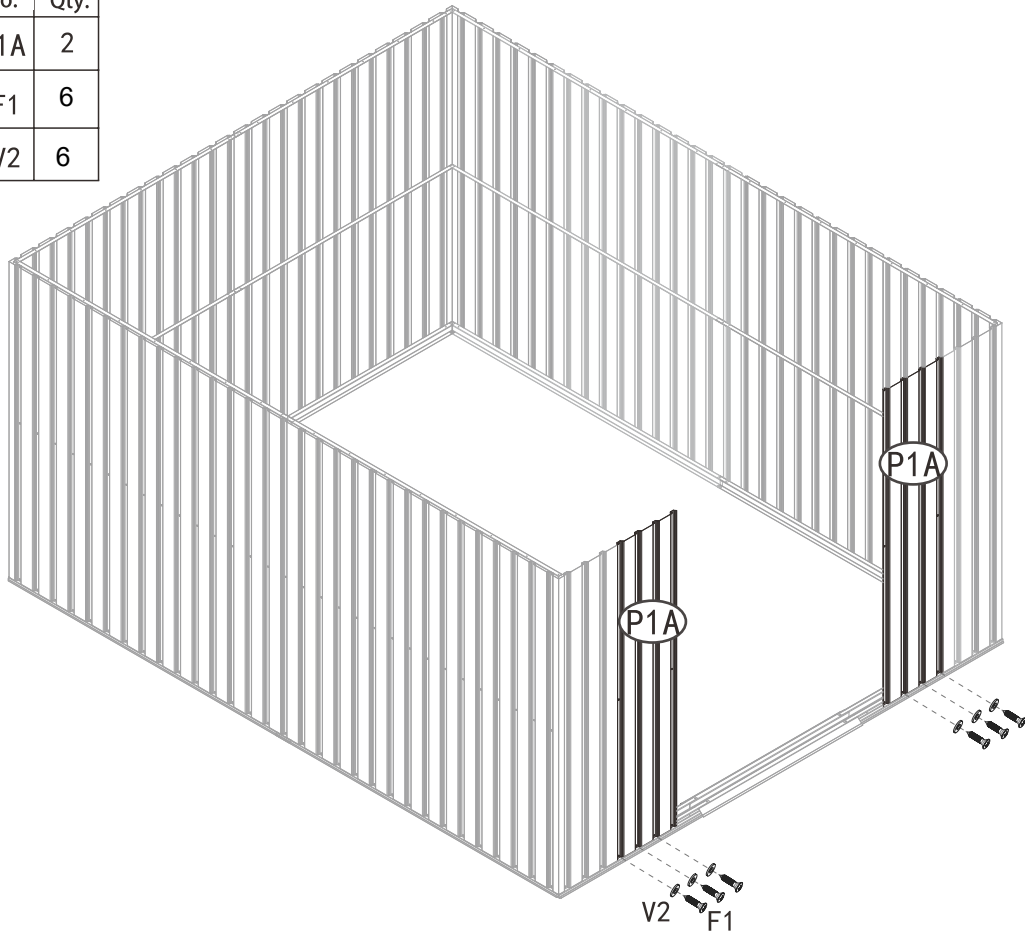





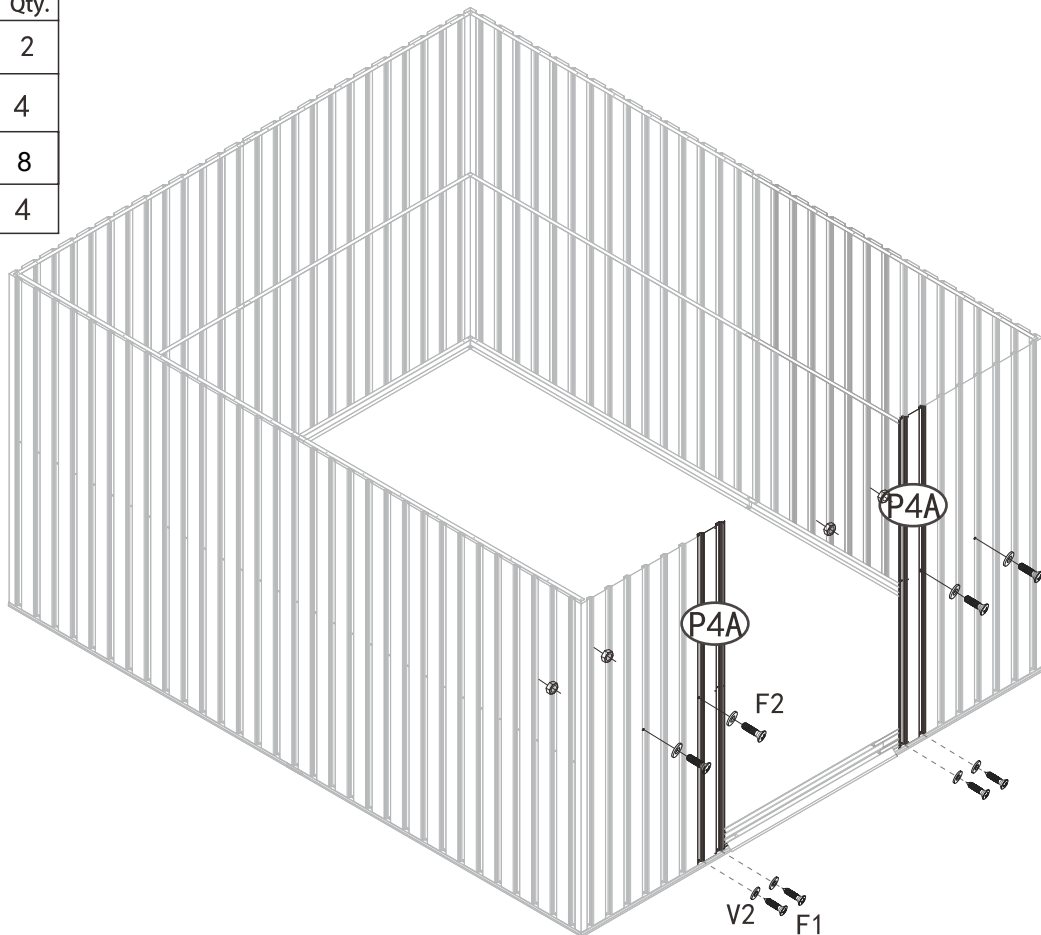

Teile / Parts	Nr. / No.	Stk. / Qty.
	P1A	2
	F1	6
	V2	6



Teile / Parts	Nr. / No.	Stk. / Qty.
	P4A	2
	F1	4
	V2	8
	F2	4





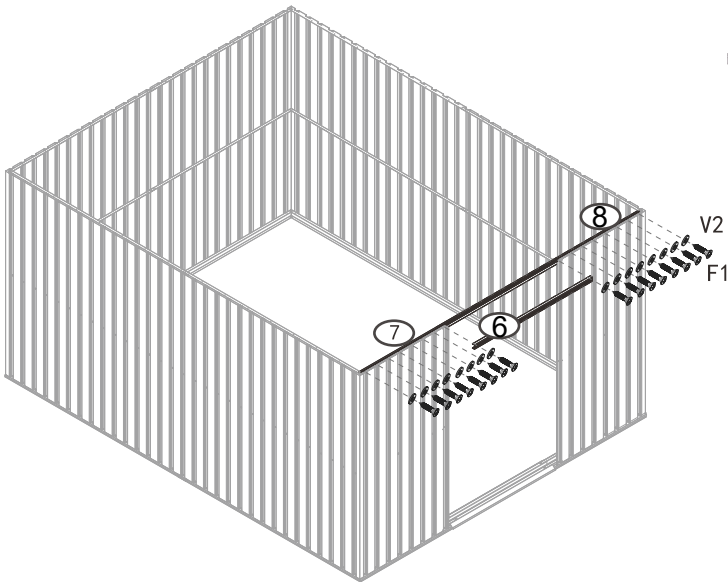
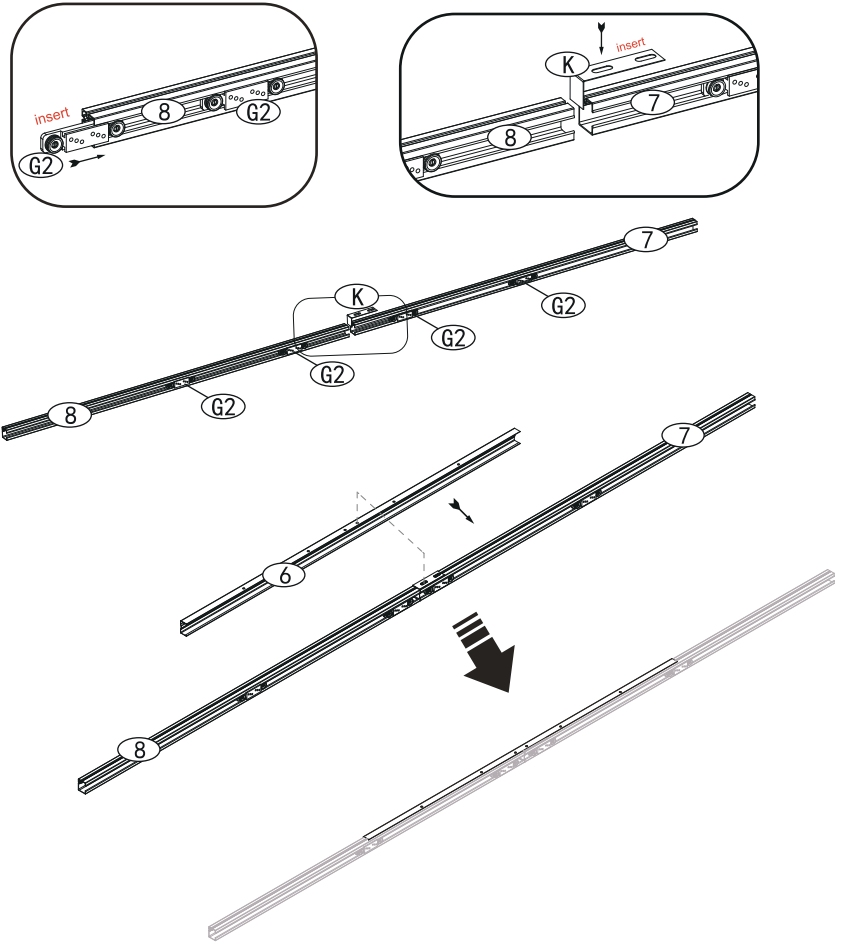

Teile / Parts	Nr. / No.	Stk. / Qty.
	6	1
	7	1
	8	1
	G2	4
	F1	16
	V2	16
	K	1

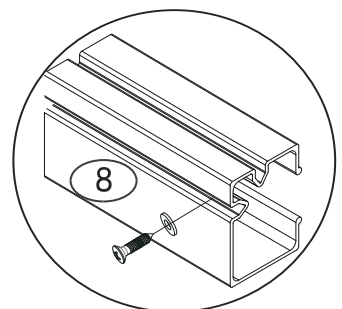
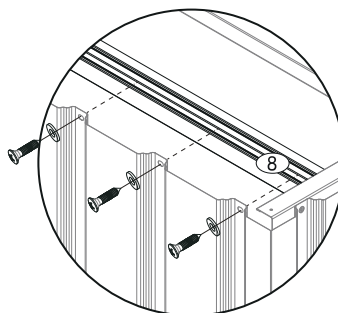
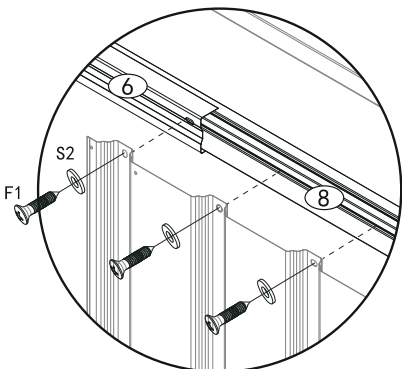

6.7.8 See the following page for installation details



Screw mounting position

Teile / Parts	Nr. / No.	Stk. / Qty.
	25L	1
	25R	1
	F1	12
	V2	12

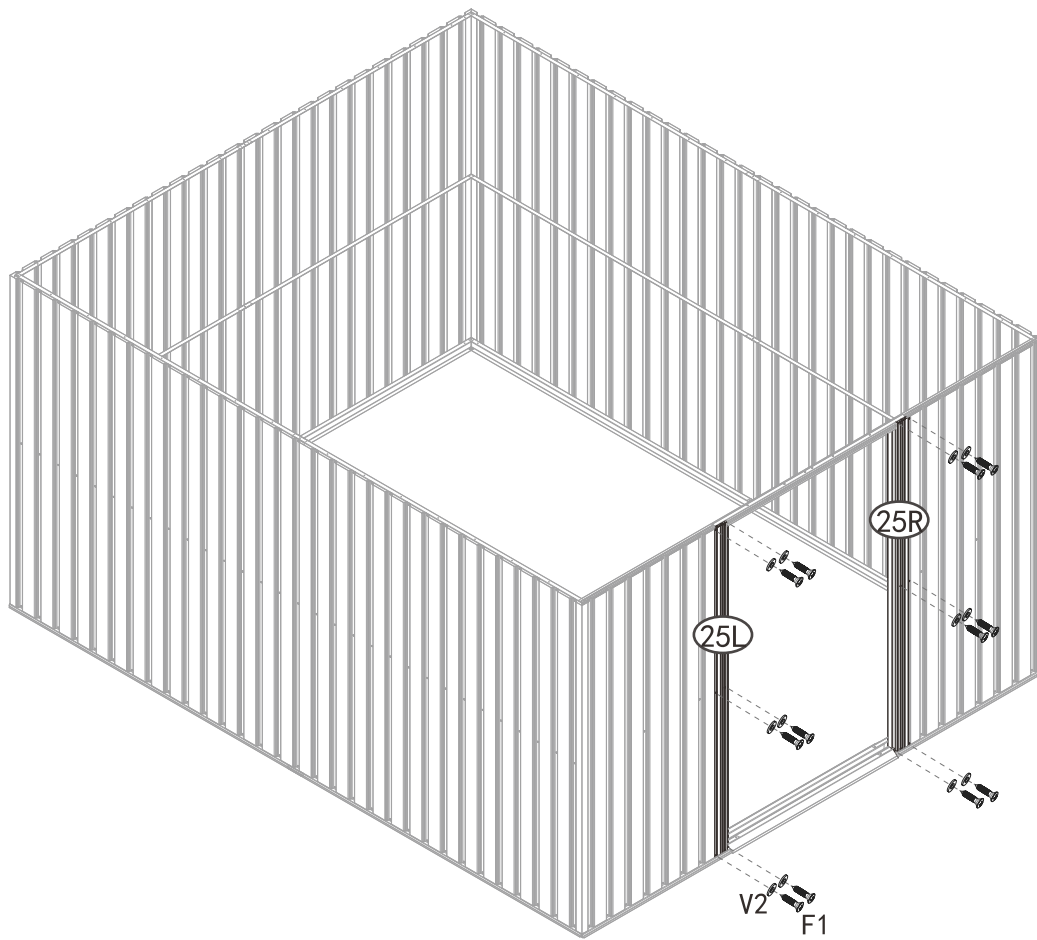

Teile / Parts	Nr. / No.	Stk. / Qty.
	21L1	1
	21L2	1
	21R1	1
	21R2	1
	F1	32
	V2	32

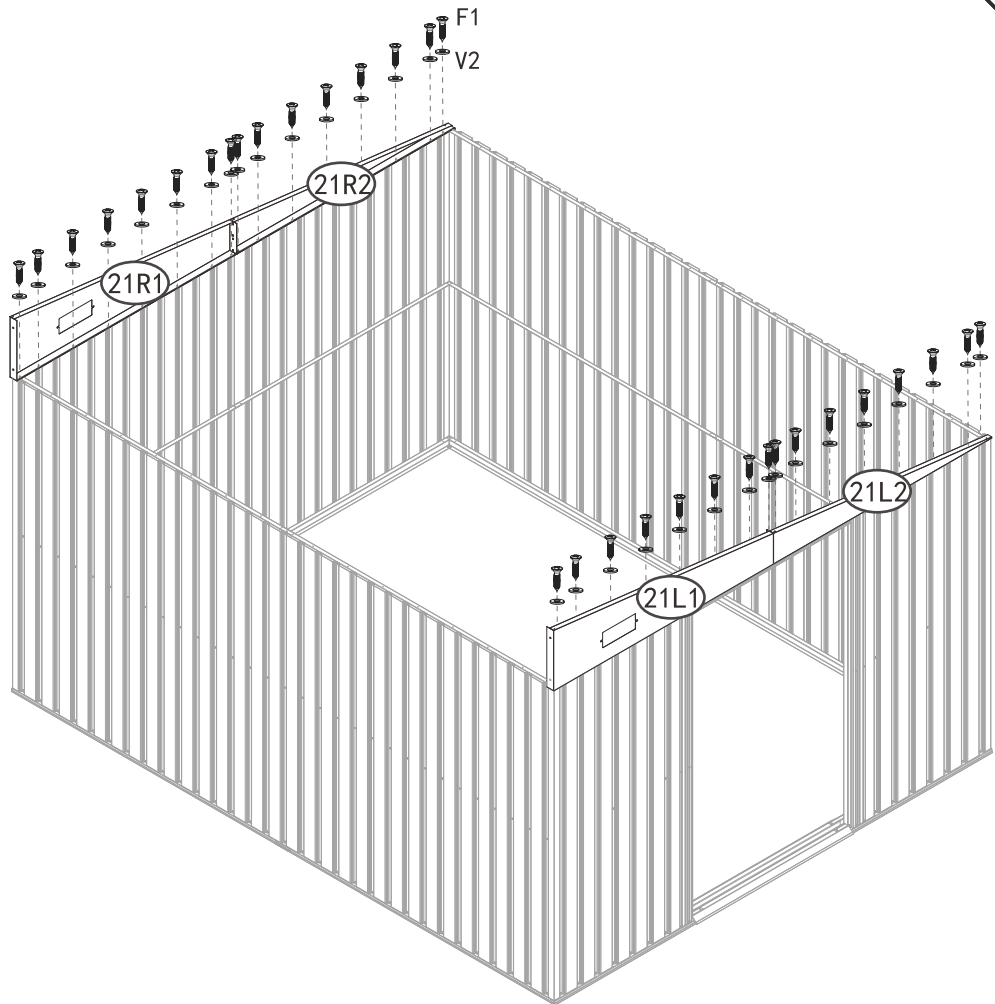

Teile / Parts	Nr. / No.	Stk. / Qty.
	B2	1
	B3	1
	F2	4

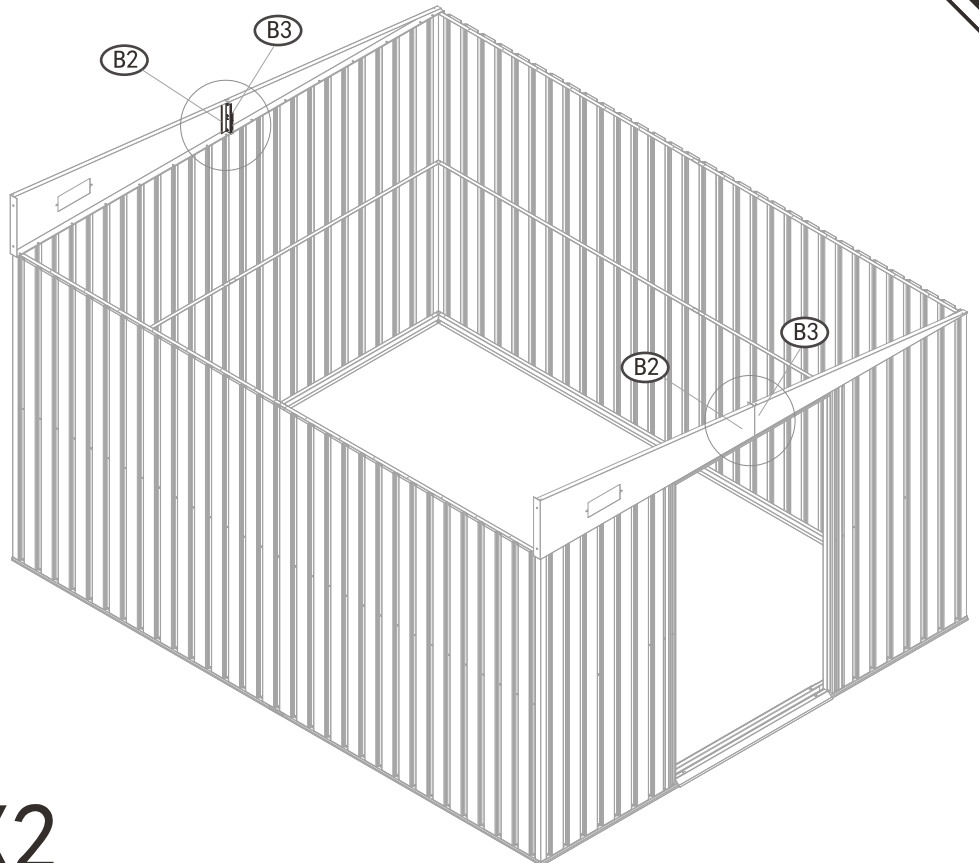



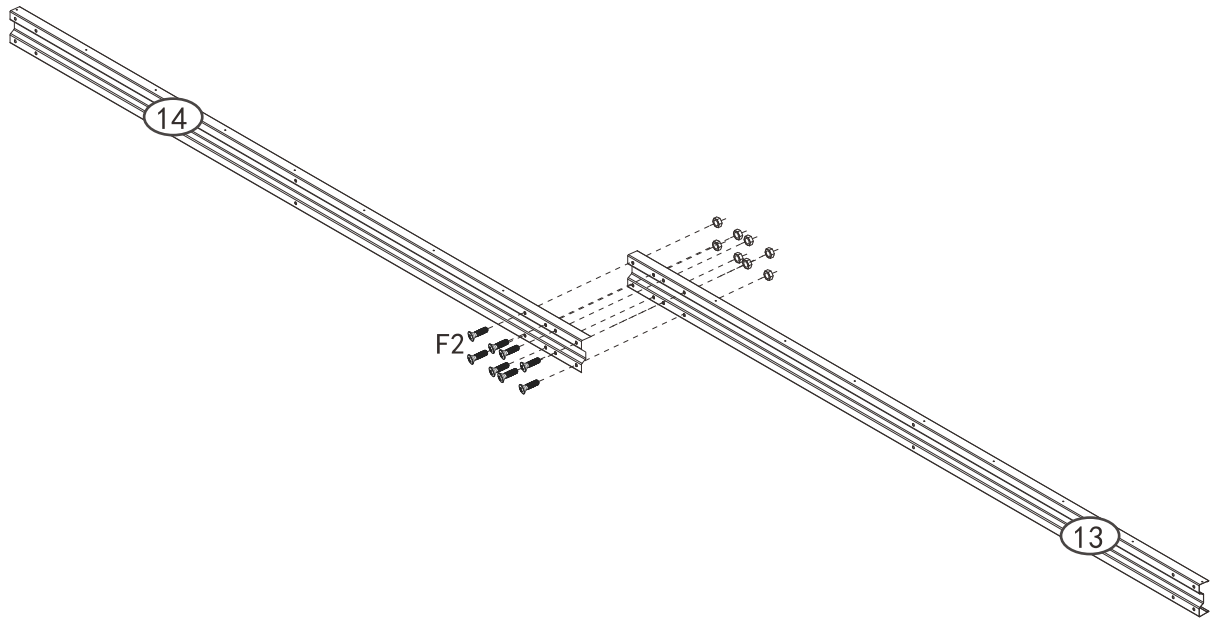

Teile / Parts	Nr. / No.	Stk. / Qty.
	13	1
	14	1
	F2	8

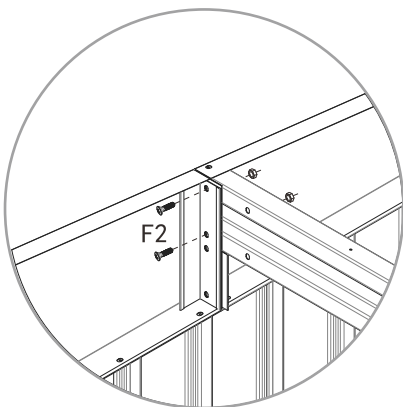
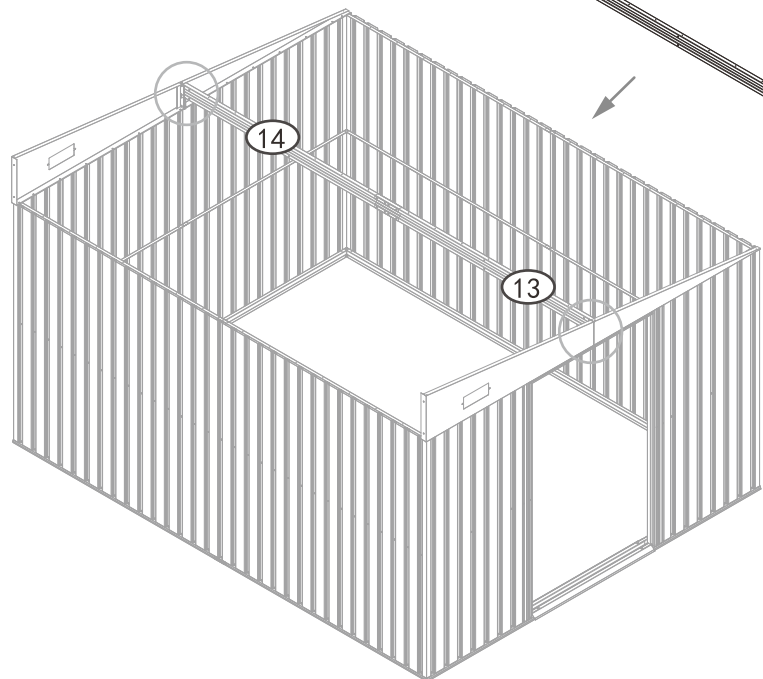
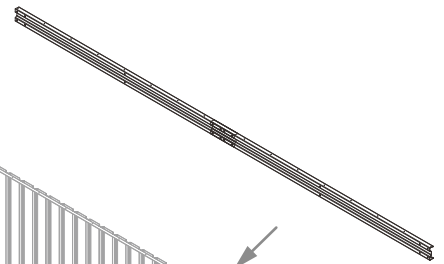



Teile / Parts	Nr. / No.	Stk. / Qty.
	F2	4



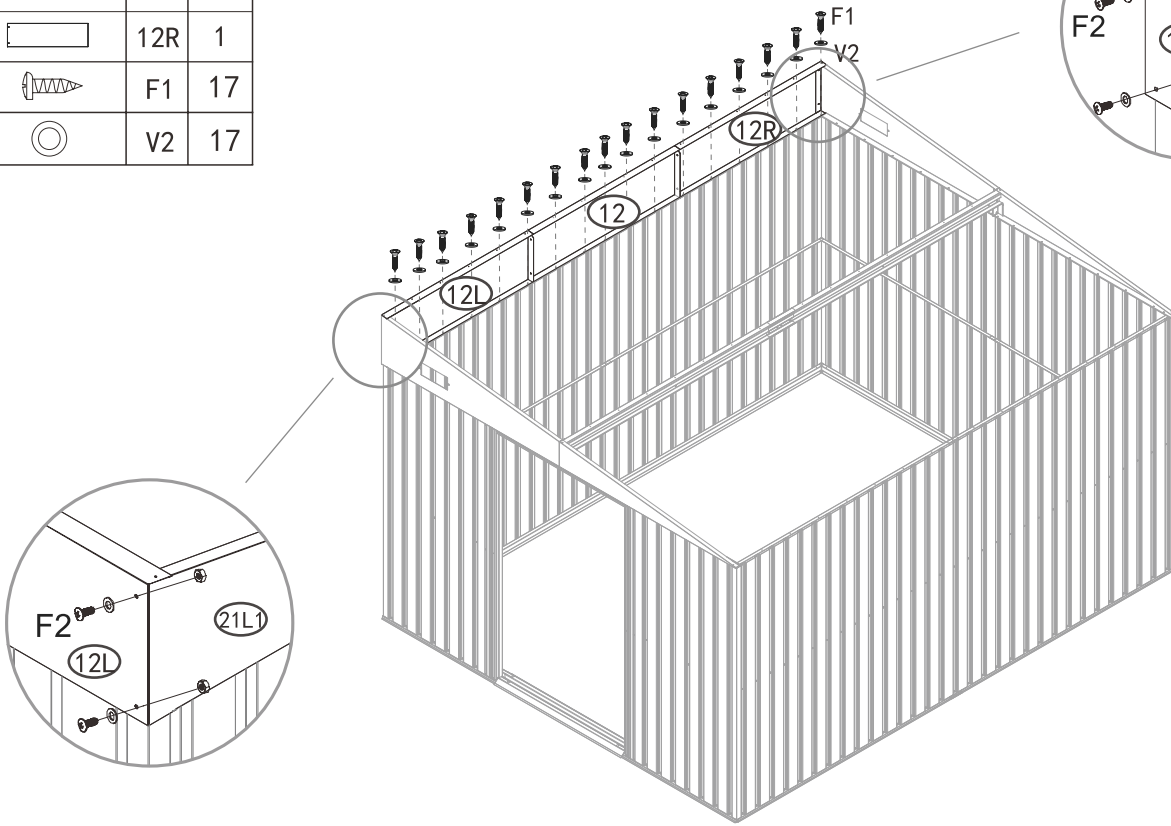

X2

Teile / Parts	Nr. / No.	Stk. / Qty.
	12L	1
	12	1
	12R	1
	F1	17
	V2	17



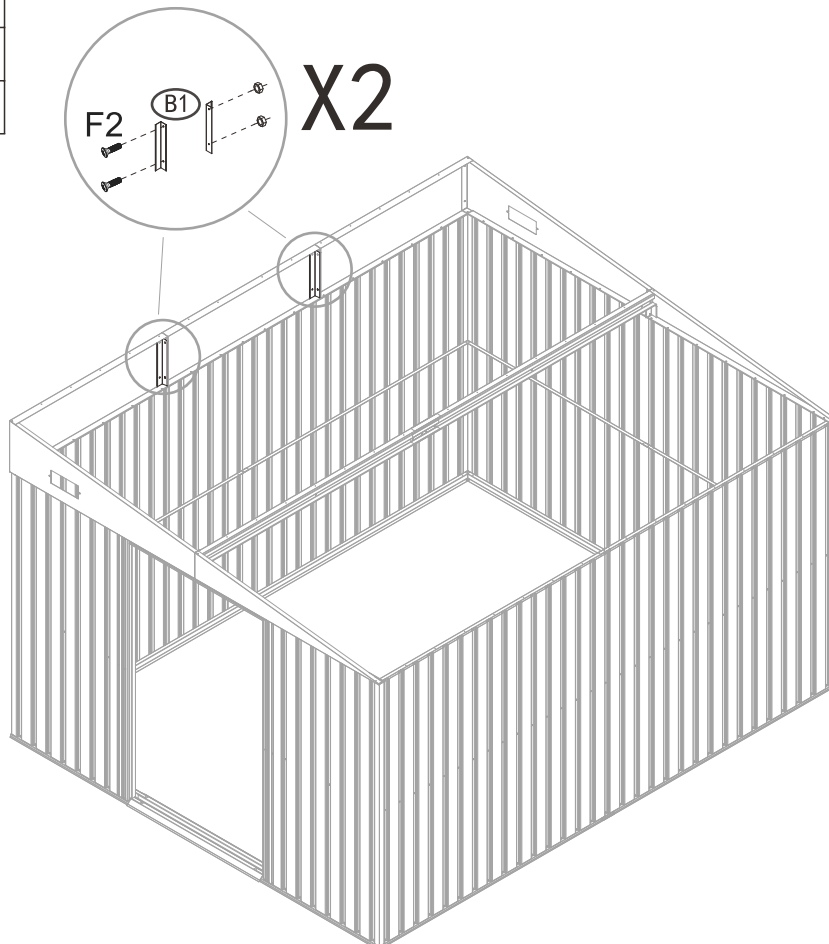



Teile / Parts	Nr. / No.	Stk. / Qty.
	B1	4
	F2	4

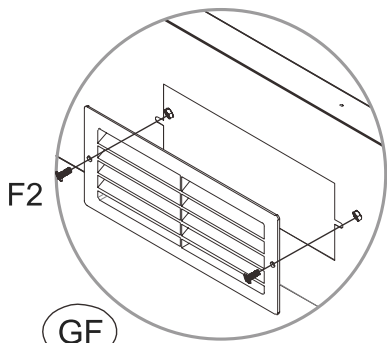
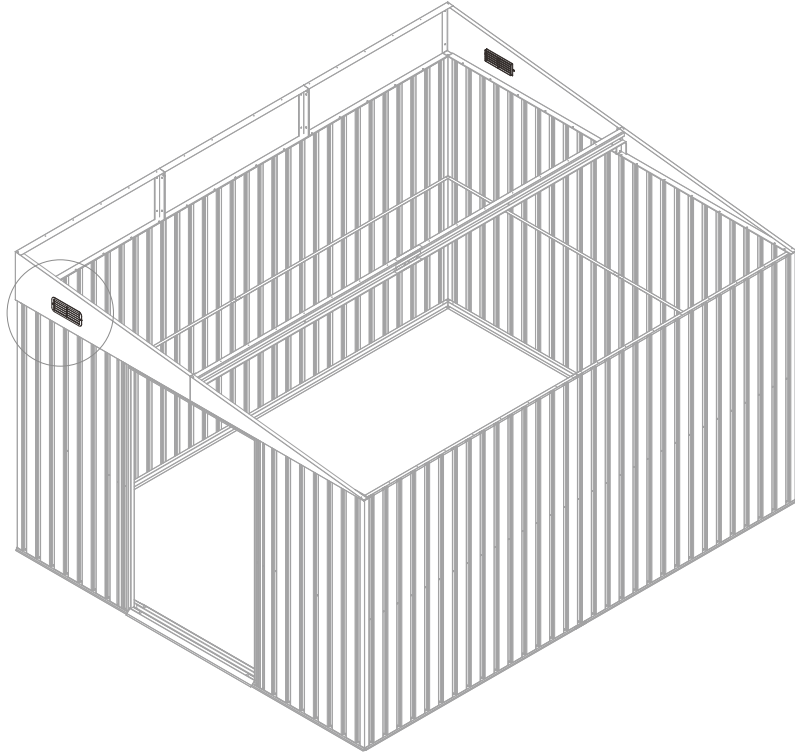





Teile / Parts	Nr. / No.	Stk. / Qty.
	GF	2
	F2	4



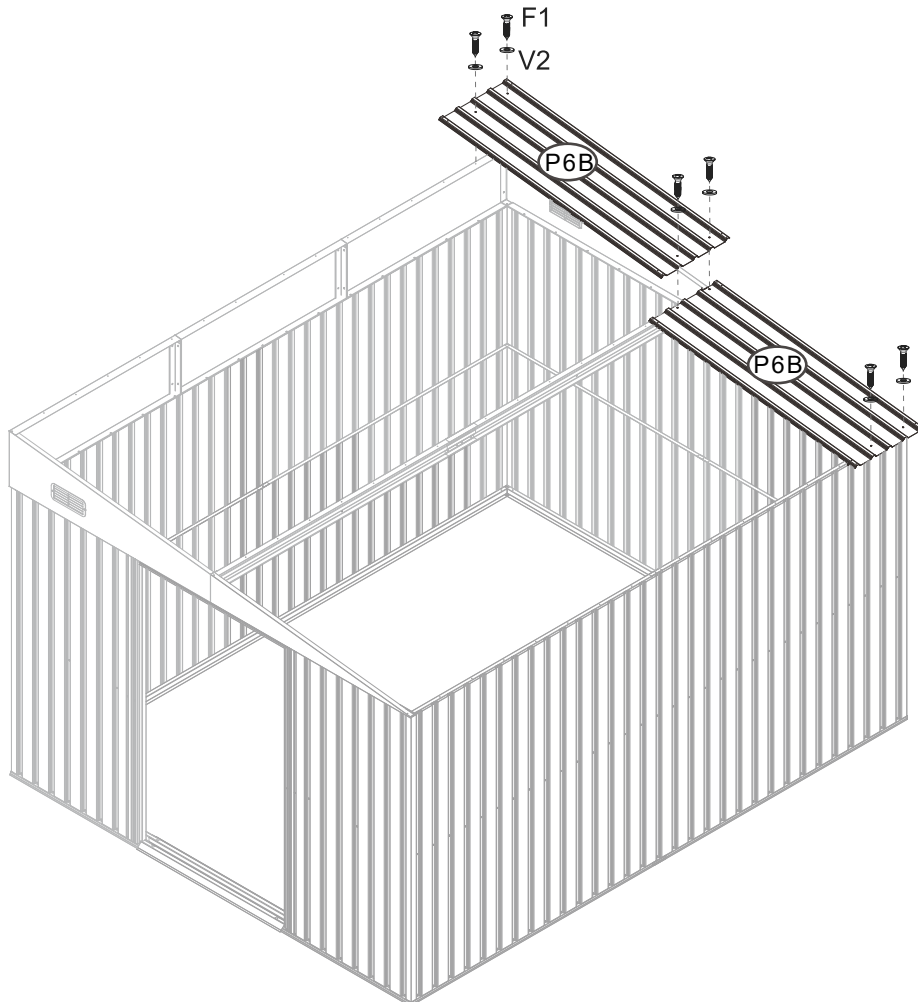



X2

Teile / Parts	Nr. / No.	Stk. / Qty.
	P6B	1
	P6	1
	F1	6
	V2	6

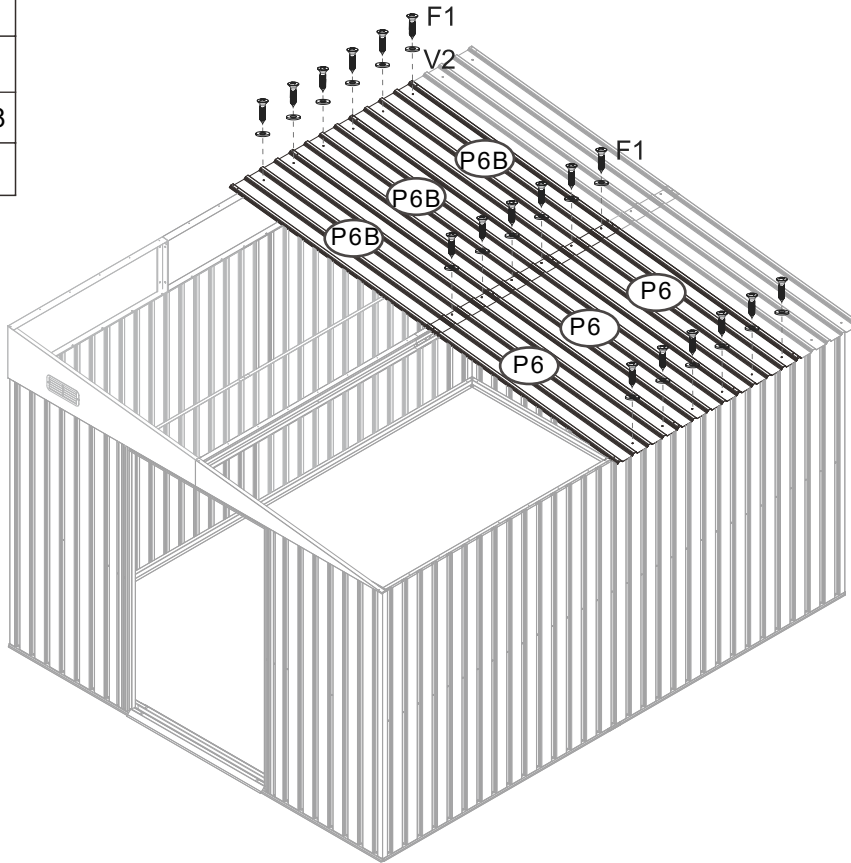

Teile / Parts	Nr. / No.	Stk. / Qty.
	P6B	3
	P6	3
	F1	18
	V2	18



Teile / Parts	Nr. / No.	Stk. / Qty.
	P5B	4
	P5	4
	F1	24
	V2	24

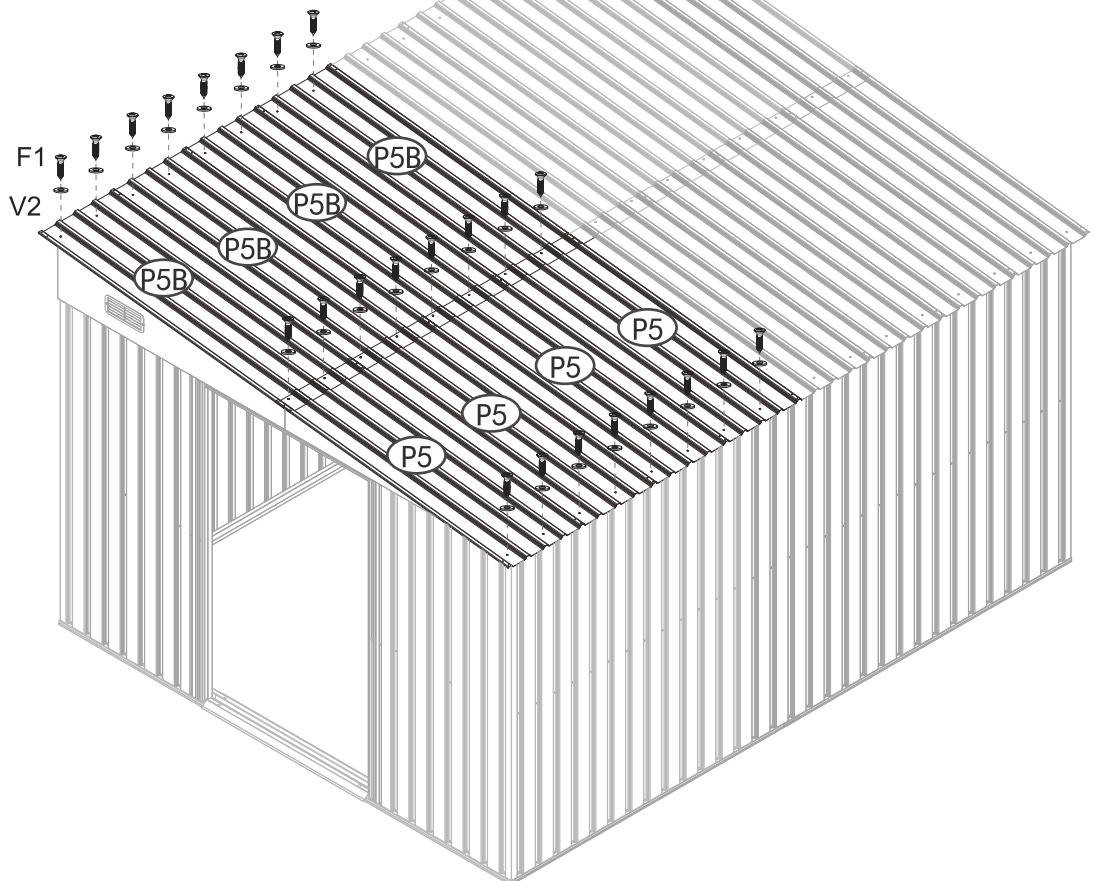

Teile / Parts	Nr. / No.	Stk. / Qty.
	15	2
	16	2
	17	4
	GC	4
	F1	8
	V2	8

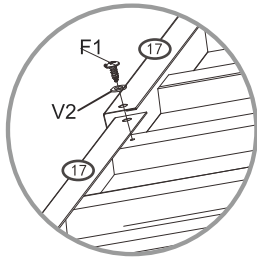

x2

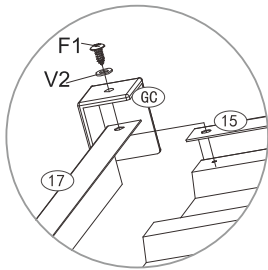
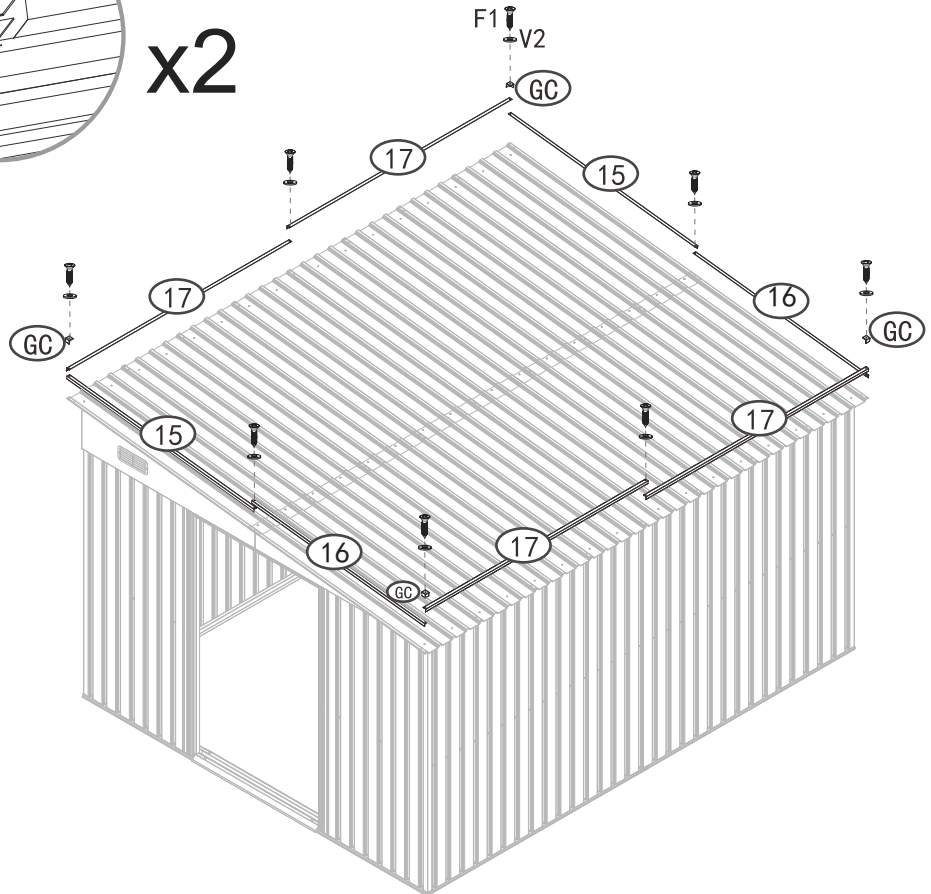

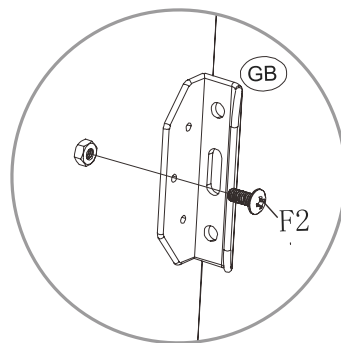
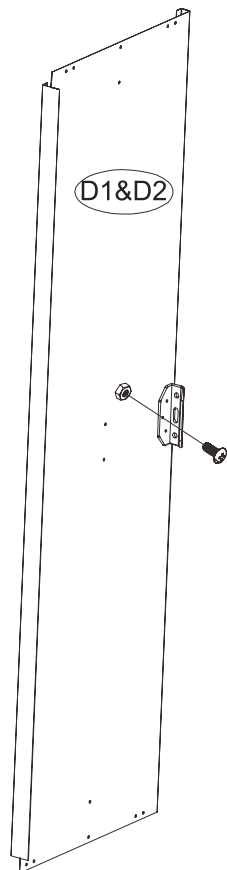

x4

Teile / Parts	Nr. / No.	Stk. / Qty.
	D1	1
	D2	1
	GB	2
	F2	2





x2

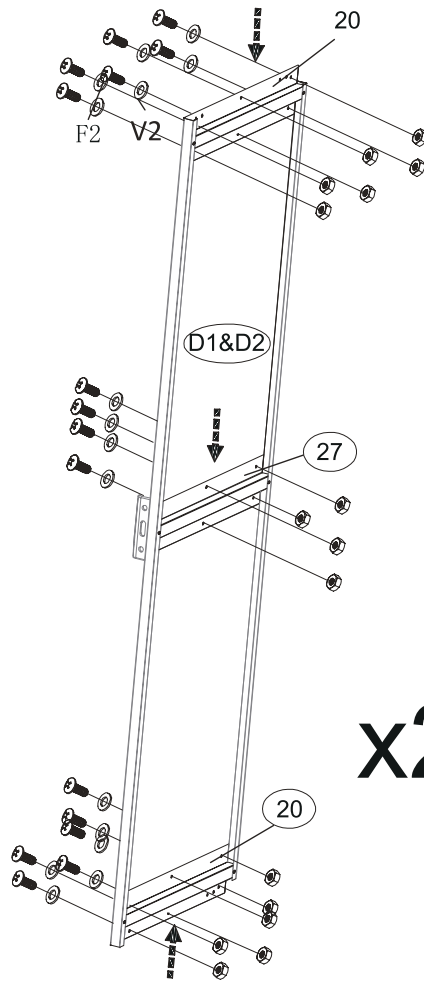



Teile / Parts	Nr. / No.	Stk. / Qty.
	20	4
	27	2
	F2	36

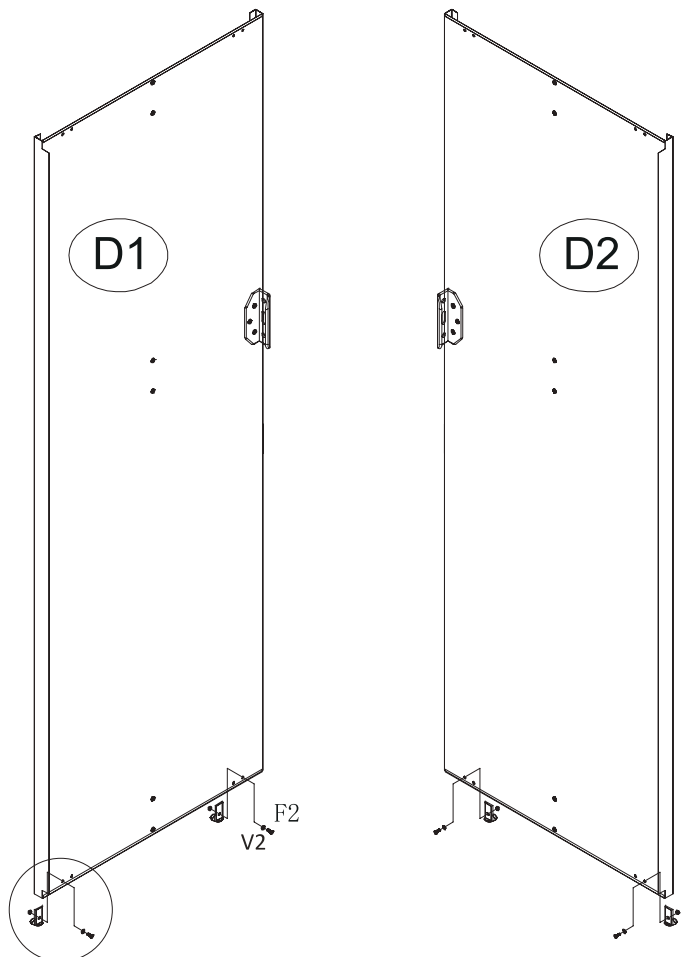
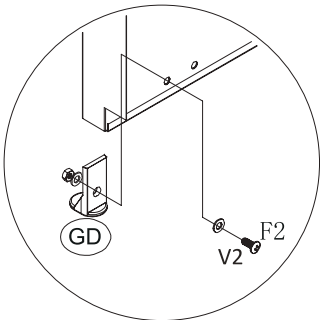

x2

Teile / Parts	Nr. / No.	Stk. / Qty.
	GD	4
	F2	4



	NO.	Qty.
	D1	1
	D2	1
	GB	2
	F2	4

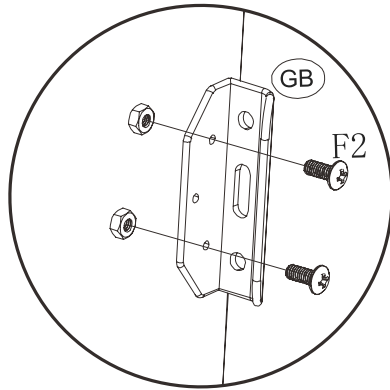
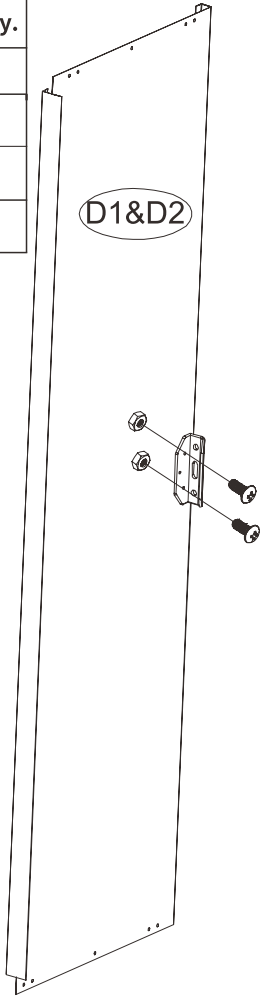

x2

PART	NO.	Qty.
	F3	8

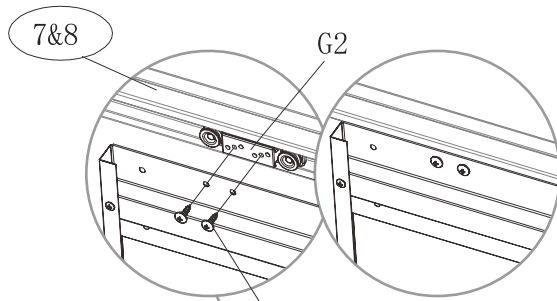

x4

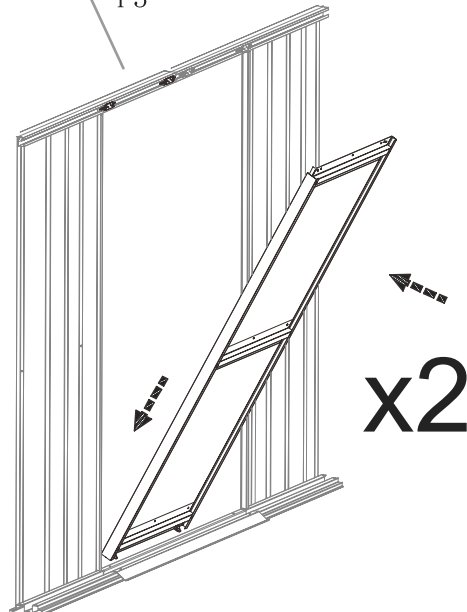

x2

PART	NO.	Qty.
	S1	260

