







# Stool With Round Tubing Legs - Wood Seat

Counter Stool  
Barstool

Examine all packaging material for small parts that may have come loose during shipment. Periodic checks are recommended to insure that all components are in proper position, tight and free from damage. Keep this assembly instruction for future reference. Adult assembly is required. This product is designed for residential use only.

CODE	QTY	HARDWARE	
1	10	1/4" x 15 Allen Bolts	
2	4	1/4" x 20 Allen Bolts	
3	2	1/4" x 25 Allen Bolts	
4	16	Φ6.5 x 1.5 Spring Washers	
5	14	Φ13 x 6.5 x 1.5 Flat Washers	
6	2	Φ16 x 6.5 x 1.5 Flat Washers	
7	1	4 x 4 Allen Wrench	

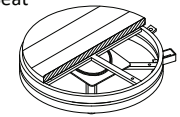
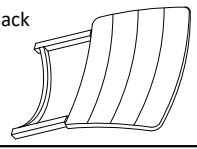
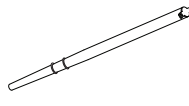
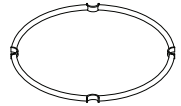
CODE	QTY	COMPONENTS	CODE	QTY	COMPONENTS
A	1	Seat 	B	1	Back 
C	4	Legs 	B	1	Support Ring 

### STEP 1

Begin assembly by attaching Back (B) to Seat (A) using 2 Allen Bolts (3), 2 Spring Washers (4) and 2 Flat Washers (6) from the sides and 2 Allen Bolts (1), 2 Spring Washers (4) and 2 Flat Washers (5) from the center. Tighten bolts with Allen Wrench (7) provided.

### STEP 2

Next attach Support Ring (D) to Legs (C) using 1 Allen Bolt (2), 1 Spring Washer (4) and 1 Flat Washer (5) per leg. Only hand tighten bolts for this step.

### STEP 3

Next attach Seat (A) to Legs (C) using 2 Allen Bolts (1), 2 Spring Washers (4) and 2 Flat Washers (5) per leg. Tighten all bolts from steps 2 and 3 with Allen Wrench (7) provided. The assembly is now complete.

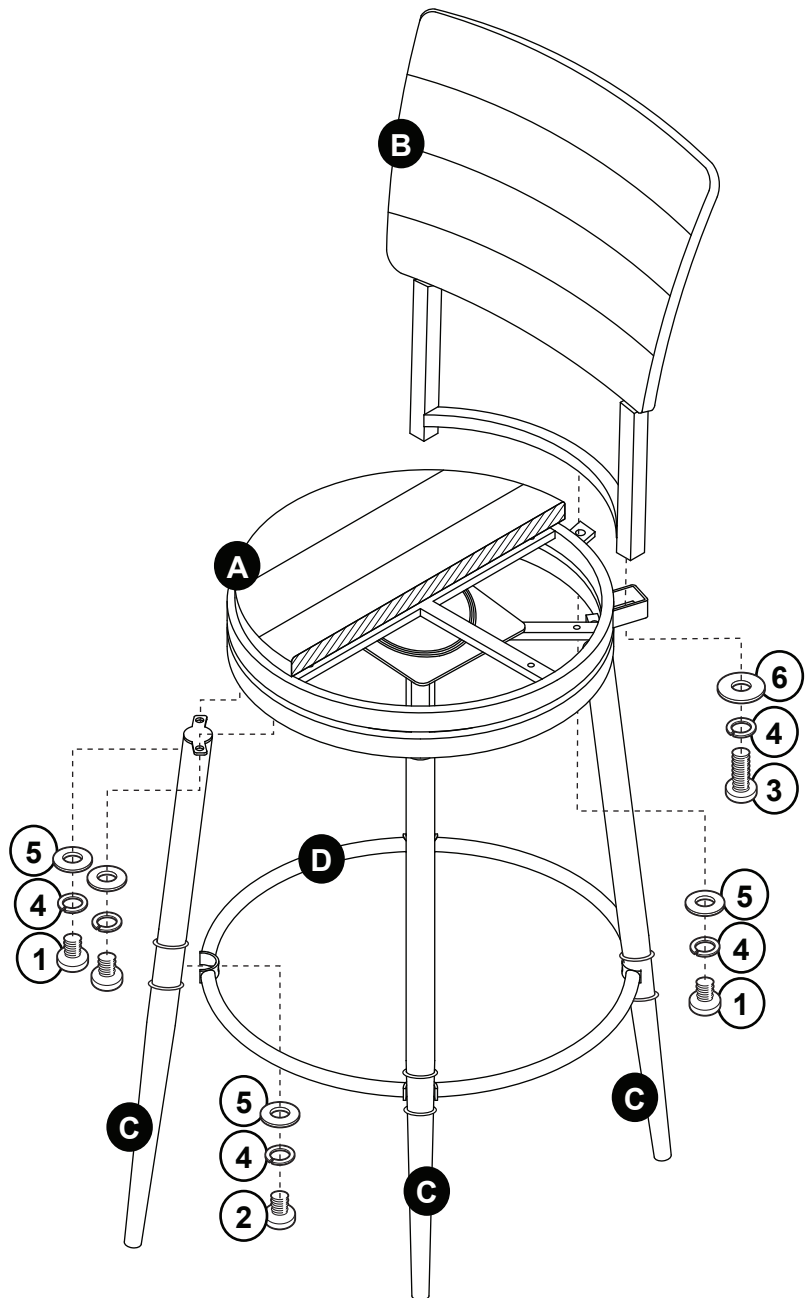

**CARE & MAINTENANCE:** The touch of a soft cloth is all the maintenance the finish will ever need. Please do not use harsh or abrasive cleaners for polishing, as they may cause damage to the finish. Periodic checks are recommended to make sure that all hardware is securely tightened.