

Applicable Models: TD-BM668A、TD-BM668B  
TD-BM669A、TD-BM669B

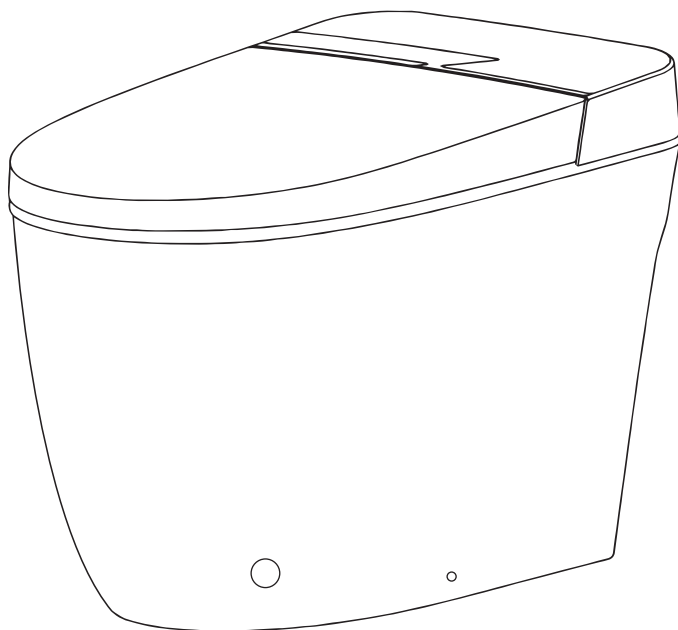

# Installation Manual

• Thank you for choosing our products. Please read the instructions carefully before installation and keep it available for future maintenance or reference.



# CONTENTS

<b>I.Description of safety precautions</b>	01
<b>II.FCC statement</b>	06
<b>III.Packing list</b>	07
<b>IV.Product component names</b> (TD-BM668A \ TD-BM668B \TD-BM669A \ TD-BM669B)	10
<b>V.Installation method</b>	11
01. Before installation	11
02. Installation space measurement	11
03. Water pressure requirements	11
04. Installation steps diagram	12
05. Wa terway interface installation and mai ntenance	15
06. Apply a sealant	15
07. Connecting the leakage protection power cord	16
<b>VI.Checklist and test running</b>	16
01. Manual Knobs	17
02. Functional overview	17
Main functions	17
Digital display introduction	17
Side knob operation definition	18
Remote controller operation instructions	20
Remote controller installation	24
03. Trial run of the whole machine	25
<b>VII.Maintenance</b>	27
<b>VIII.Common troubleshooting</b>	28
<b>IX.Technical specification parameters</b>	29





# I.Description of safety precautions

**VERY IMPORTANT!!! Please read all instructions and warnings before using this product!Symbols and meanings!!!**

 **WARNING:** Indicates that if this sign is ignored and misuse, serious injury or death may result.

 **NOTE:** Indicates that if you ignore this sign and operate it incorrectly, it may cause personal injury or property damage.

**The following symbols indicate important safety matters that must be paid attention to when using the product.**

SYMBOLS	IMPORTANT:Please read all instructions before use
	The symbol indicates prohibited items when using the product.
	Users are required to use the product in accordance with the prescribed operating methods.

- This product is a Class I electrical equipment, and grounding measures must be taken when connecting to the power supply.
- Install this equipment near an electrical outlet that has a ground fault circuit interrupter function.
- This appliance is not intended for use by persons (including children) with reduced physical, sensory or mental abilities or lack of relevant experience and knowledge, unless they have been given supervision or instruction regarding use of the appliance by a person responsible for their safety.
- It is strictly prohibited for children to use it alone. If children need to use it, adults should supervise and accompany it to ensure that children do not play or tamper with the appliance.

## **WARNING-Important Safety Instructions**

	<ul style="list-style-type: none"> <li>• Do not install or use this product in humid places such as steam rooms. Keep the product vent unobstructed and free of any debris</li> </ul>
	<ul style="list-style-type: none"> <li>• Connect only to a grounded-type outlet protected by a ground fault circuit interrupter (GFCI).</li> </ul> <p><b>Grounding instructions:</b> This product should be grounded. In the event of an electrical short circuit, grounding reduces the risk of electric shock by providing an escape line for the electrical current. This product is equipped with a grounding cord with a grounding plug. The plug must be inserted into a properly installed and grounded outlet.</p> <p><b>Improper use of grounding plugs can lead to risks.</b> If the product must be rewired for use on a different type of circuit, the rewiring should be performed by qualified service personnel.</p>
	<ul style="list-style-type: none"> <li>• This product should only be used with 110V-120V~, 60Hz current and load, and the current is at least 15A.</li> </ul> <p>The power plug must be equipped with a ground fault circuit interrupter or a ground fault leakage protector or similar highly sensitive and fast leakage switch. (rated sensitive current below 6mA) Do not use temporary adapter.</p>
	<ul style="list-style-type: none"> <li>• <b>Do not plug or unplug the power plug with wet hands.</b> Doing so may cause electric shock.</li> </ul>

	<ul style="list-style-type: none"> <li>• During thunder, it is strongly recommended to unplug the power cord.</li> <li>• Porcelain toilets must have floor fixing bolts installed.</li> <li>• This product comes with a soft-closing seat cover. Do not push the toilet seat closed as this may damage the toilet seat.</li> </ul>
	<ul style="list-style-type: none"> <li>• Do not get water or cleaning fluid on the top of the unit or power plug. Doing so may cause fire, electric shock, burns, or short circuits; it may cause the product to rupture, resulting in personal injury or property damage. Never drop or insert any object into any opening or hose.</li> </ul>
	<ul style="list-style-type: none"> <li>• Do not disassemble, repair or modify this product. Doing so may cause fire, electric shock, burns, or short circuits and may void the product warranty.</li> <li>• Never install the product on a moving vehicle such as a trailer or boat. Doing so may cause fire, electric shock, burns, short circuits, or malfunction, and moving parts of this product may become loose and fall off, causing personal injury.</li> </ul>

 **WARNING-Reduce the risk of burns, electric shock, fire or personal injury**

	<p><b>If malfunction occurs, do not use the device.</b>  <b>Be sure to unplug the power plug from the electrical outlet.</b></p>
	<ul style="list-style-type: none"> <li>• Troubleshooting possible causes that cause the water supply valve to close, and stop water supply:  Water pipe or tank leaking  Product is cracked or damaged  The product makes strange noises or smells strange  Product smokes  Product is abnormally hot  Ceramic body device clogged  The toilet seat is not in its original position  Continued use after a malfunction may result in fire, electric shock,  Personal injury or property damage</li> <li>• <b>Only tap water or potable well/ground water should be used. Do not use sea water.</b>  Doing so may irritate the skin and cause malfunction.</li> <li>• <b>Do not touch the power plug during a thunderstorm.</b>  Doing so may cause fire or electric shock.</li> <li>• <b>Do not allow the water supply hose to come into contact with the electrical plug or socket.</b>  Doing so may cause condensation, which may cause fire, electric shock,  Burns, or short circuits. Keep the cord away from heated surfaces.</li> <li>• <b>Do not do anything that may damage the power cord or power plug.</b></li> <li>• <b>Do not hit, pull, twist, excessively bend, damage, alter, or heat the power cord.</b></li> <li>• <b>Do not place any heavy objects on the power cord, bundle it, or pinch it.</b>  Using a damaged power cord may cause fire, electric shock, burns, or short circuits.</li> <li>• <b>Do not use a loose or faulty electrical outlet.</b>  Doing so may cause a fire or short circuit.</li> <li>• <b>Do not use any receptacle or wiring device that exceeds the specified rating.</b>  Plugging multiple plugs into the same outlet (such as using an outlet splitter) may cause a fire due to overheating.</li> <li>• <b>Do not use any power supply other than the specified power supply (AC120V, 60Hz)</b>  Doing so may cause fire, malfunction, or overheating.</li> </ul>



- **Do not put your fingers or anything else into the heater vent.**  
**Do not place anything on the heater vent or cover them with clothing.**  
Doing so may cause burns,electric shock,or malfunction.
- **Keep cigarettes and other open flames away from the product.**  
Otherwise,a fire may occur.



## **WARNING-Danger of irritation or burns**

- Improper use of a toilet seat can cause irritation or burns.  
When users sit on the heated seat at high temperatures for more than 30 minutes,low-temperature burns may occur to the human body.
- Young children,the elderly and other users who are unable to set the appropriate temperature on their own,including:those who are sick,physically disabled and others who do not have freedom of movement;those who use any medication that causes drowsiness(sleeping pills or cold medicines),those who drink alcohol,anyone who is severely fatigued and anyone else who falls asleep easily is at risk.Never use while sleeping or drowsy.
- This is an electrical product. Do not install it anywhere where water may enter,or where the humidity is high enough that water may form on the product surface.
  - Do not use outdoors or operate where aerosol (spray) products are being used or where oxygen is being administered.
- **DANGER-** To reduce the risk of electrocution:Do not use while bathing,please install a fan or vent to ensure good air circulation in the bathroom.Otherwise it may cause fire or electric shock.
- Always connect the water inlet pipe of a smart toilet installed in the bathroom to the cold water supply.  
Connecting a hot water supply may cause burns and damage to the equipment.
- Make sure you have a properly grounded (3-prong)outlet installed .  
Failure to install a grounded outlet may result in electric shock in the event of a malfunction or short circuit.
- Plug the power plug firmly into the outlet.  
Failure to do so may result in fire,overheating or short circuit.
- To unplug the power cord,hold the plug,not the cord.  
Do not unplug the power cord by pulling on it.Pulling on the power cord may cause damage and result in fire or overheating.
- If the power cord is damaged,you must use a dedicated power cord or purchase a dedicated power cord from the manufacturer or its maintenance department and ask the manufacturer' s maintenance department or equivalent professionals to replace the power cord to avoid danger.
- Always unplug the power plug from the electrical outlet before cleaning,maintenance or inspection.  
Failure to do so may result in electric shock or product malfunction.Unless“nozzle cleaning”is used.
- Regularly remove dust and dirt from the power plug and make sure the power plug is securely plugged into the wall outlet.  
Failure to do so may result in fire,overheating or short circuit.When cleaning,please unplug the power plug from a well-grounded power socket and wipe it clean with a dry cloth.





- Before removing the upper cover of the product, be sure to unplug the power plug. Failure to do so may result in fire or electric shock.
- Studies in women indicate that overuse of the continuous wash function increases the likelihood of dryness of the vaginal mucosa and may reduce the number of required microorganisms.
- Although these studies have not been proven, talk to your healthcare provider to see if these conditions apply to you. More importantly, if you are a person with any immune deficiency due to illness, chemotherapy, or other conditions that compromise the immune system, you should consult your healthcare provider before using this product.



## WARNING



- Use this product only for its intended use as described in this manual. Do not use attachments not recommended by the manufacturer. Doing so may cause the entire unit to come loose and fall, resulting in personal injury.
- If the product is damaged, please do not touch the damaged parts. Doing so may result in electric shock or injury. It should be replaced immediately.
- Do not use force, mechanical impact, step on or stand on the toilet seat, lid or upper device. Also do not place any heavy objects on the toilet seat, lid or upper device. Doing so may cause the upper device assembly to break or become loose and fall, resulting in personal injury. May damage the product and cause personal injury or property damage.
- Do not lift this product by the toilet seat or lid.
- Do not lift the toilet seat or lid when something is resting on the toilet. Doing so may cause the upper device assembly to loosen and fall, resulting in personal injury.
- When cleaning or maintaining plastic parts (top fittings, etc) or water supply hoses, use a kitchen cleaner diluted with water. Do not use any of the following: toilet cleaners, household cleaners, benzene, paint thinner, powdered cleaners or nylon scrubbing pads. These items may damage or crack the plastic and cause personal injury or loss of functionality. The water supply hose may be damaged and cause water leakage.
- To prevent sudden water leakage, do not remove the water filter drain valve when the angle valve is open. Doing so will cause water to spurt out. (See page 25 for instructions on cleaning the water filter drain valve.)
- Do not fold or squeeze the water supply hose, or cut it with sharp objects and cause damage. Doing so may cause water leakage.
- Don't pour hot water into the toilet. Doing so may damage the toilet, cause personal injury, or cause water to enter.
- Do not flush anything other than human waste and toilet paper. Also, don't flush too much toilet paper. Doing so may clog the toilet, causing wastewater overflows and the sewer clogged.



- If water leakage occurs, always close the shut-off valve.
- Protect pipes and hoses from damage due to freezing when ambient temperatures may drop to 0°C (32°F) or below.

Frozen water pipes can cause overhead fixtures and water pipes to break, causing water leaks.

- Regulate room temperature to prevent pipes and hoses from freezing during colder months. Move the product from a cold or humid environment to normal room temperature and wait 2 hours until the condensation has completely evaporated.

Doing this will prevent the product from shorting out the power supply.

- When the product is not used for more than 3 days, drain the water from the toilet and unplug the power plug from the wall socket.
- When a product malfunction occurs, stop using the product and turn off the power. Request professional services.

- When the device is not used for a long time, close the angle valve to cut off the water source, drain the water from the upper cover device and water supply hose, and unplug the power plug.

When using the product again, please allow water to flow to the product again.

Otherwise, the water in the tank may become contaminated and cause skin inflammation or other problems.

Leaving the power on may cause fire or overheating.

- When installing the water filter drain valve, you must ensure that it is securely tightened in the correct position.

If not tightened securely, water leakage may result.

- If the toilet unit is clogged, unplug it and clear the blockage.

At this time, if the automatic flushing function is normal, wastewater in the toilet may overflow and may cause damage to the sewer pipe.

- Use commercially available tools for unclogging toilet fixtures to clear the clog.

- Keep flushing, even after urinating.

Failure to do so may result in insufficient flushing or blockage in the ceramic pelvis, resulting in wastewater overflow and sewer line damage.

- Wipe condensation from toilet fixtures, tank, supply lines and shut-off valve with a dry cloth. Condensation may cause staining and corrosion of floors.

Ventilate the restroom to prevent condensation.

- Use a well-wrung mop or cloth to wipe urine, condensation, detergent, water, etc.

Failure to do so may result in contamination and corrosion of the floor.

## II.FCC statement

### FCC ID: 2BKKS-BM668Y55504

This device complies with Part 15 of the FCC Rules. Operation is subject to the following two conditions: (1) this device may not cause harmful interference, and (2) this device must accept any interference received, including interference that may cause undesired operation.

Changes or modifications to this unit not expressly approved by the party responsible for compliance could void the user's authority to operate the equipment.

 **Note:** This equipment has been tested and found to comply with the limits for a Class B digital device, pursuant to Part 15 of the FCC Rules. These limits are designed to provide reasonable protection against harmful interference in a residential installation. This equipment generates uses and can radiate radio frequency energy and, if not installed and used in accordance with the instructions, may cause harmful interference to radio communications.

However, there is no guarantee that interference will not occur in a particular installation. If this equipment does cause harmful interference to radio or television reception, which can be determined by turning the equipment off and on, the user is encouraged to try to correct the interference by one or more of the following measures:

- Reorient or relocate the receiving antenna.
- Increase the separation between the equipment and receiver.
- Connect the equipment into an outlet on a circuit different from that to which the receiver is connected.
- Consult the dealer or an experienced radio/TV technician for help.

### IC :32765-BM668Y55504





This device contains licence-exempt transmitter(s)/receiver(s) that comply with Innovation, Science and Economic Development Canada's licence-exempt RSS(s). Operation is subject to the following two conditions:

- (1) This device may not cause interference.
- (2) This device must accept any interference, including interference that may cause undesired operation of the device.





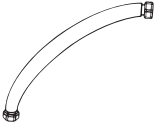
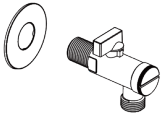
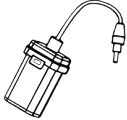
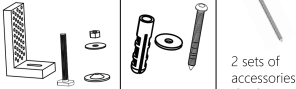

L' émetteur/récepteur exempt de licence contenu dans le présent appareil est conforme aux CNR d' Innovation, Sciences et Développement économique Canada applicables aux appareils radio exempts de licence. L' exploitation est autorisée aux deux conditions suivantes :

- (1) L' appareil ne doit pas produire de brouillage;
- (2) L' appareil doit accepter tout brouillage radioélectrique subi, même si le brouillage est susceptible d' en compromettre le fonctionnement.

### III.Packing list

Checklist Items		
		
Main body	Remote controller (Applicable to models TD-BM668A \ TD-BM668B \ TD-BM669A \ TD-BM669B)	Special oil sludge for sewage outlet
		
Install cardboard	Installation Manual	Matching special water inlet braided hose
		 <p>sets of accessories</p> <p>4 sets of 2 accessories</p> <p>2 sets of accessories for fixing ceramics on the side</p>
Angle valve G1/2" to G1/2"	Battery box(optional)	Anchor screw assembly (for fixing ceramics)

#### Required Tools:

Screwdriver 	Wrench 	Marker 
Tape measure 	Caulking gun 	Electric Drill 

## Main body dimensions

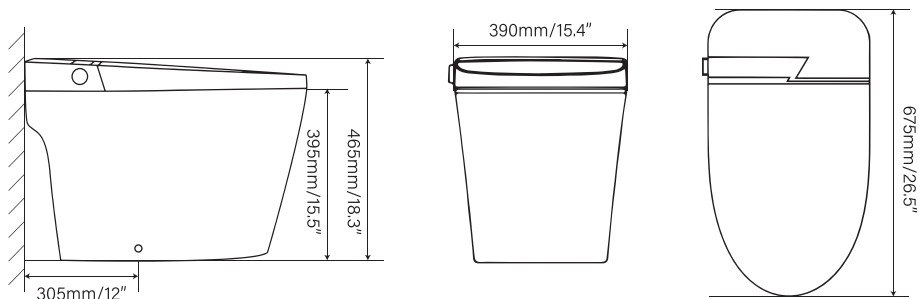

TD-BM668A, TD-BM668B

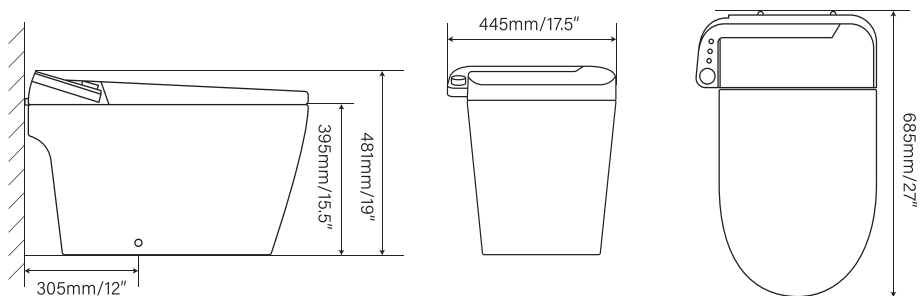

TD-BM669A, TD-BM669B

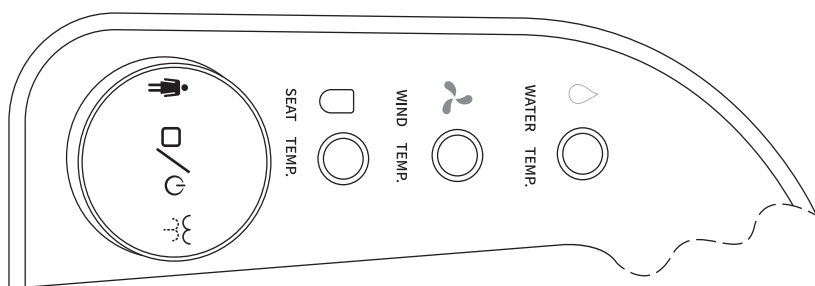

TD-BM669A, TD-BM669B

- The above drawing dimensions are not the actual proportions of this product and are for reference only.
- When installing in cold weather, place the unit at a room temperature greater than 41 degrees Fahrenheit for at least four hours before installation.

### Configuration table

Function description	Items				Illustrate	Remark
	TD-BM668A	TD-BM668B	TD-BM669A	TD-BM669B		
Rear wash	●	●	●	●		
Female wash	●	●	●	●		
Reciprocating wash	●	●	●	●		
Water pressure adjustable	●	●	●	●		
Water temperature adjustable	●	●	●	●		
Nozzle position adjustable	●	●	●	●		
Nozzle self-clean	●	●	●	●		
Seat heating	●	●	●	●		
Seating sensor	●	●	●	●		
Pre wetting	●	●	●	●		
Seat temperature adjustable	●	●	●	●		
Warm wind drying	●	●	●	●		
Wind temperature adjustable	●	●	●	●		
Knob control	●	●	●	●		
Remote controller	●	●	●	●		
HD display	●	●	●	●		
Night light	●	●	●	●		
Auto flush after leave	●	●	●	●		
Foot-touched flush	●	●	●	●		
Flushing during power outage	●	●	●	●		
Instant heating	●	●	●	●		
Energy saving ECO	●	●	●	●		
Prevent low temperature burns	●	●	●	●		
Remote control open cover/seat		●		●		
Remote control close cover/seat		●		●		
Flush (big/small flush)	●	●	●	●		
Vacuum breaker	●	●	●	●		
Atmosphere light	●	●	●	●		
Energy saving and environmental protection	●	●	●	●		
Leakage protection power cord	●	●	●	●		
Manual open cover	●		●			
Manual open seat	●		●			
Button controlled water temperature			●	●		
Button controlled wind temperature			●	●		
Button controlled seat temperature			●	●		

## IV. Product component names

(TD-BM668A \ TD-BM668B \ TD-BM669A \ TD-BM669B)

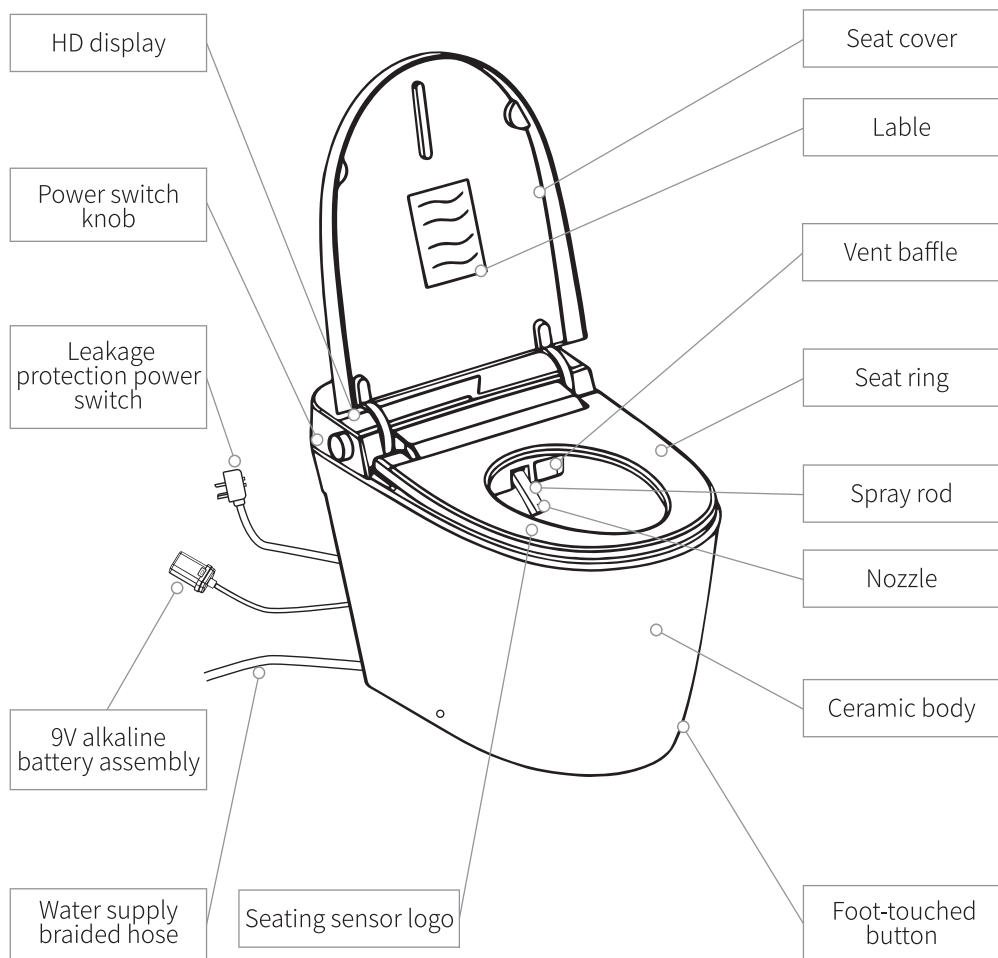

# V.Installation

## 01.Before installation

- There is enough space around the unit and make sure the bathroom door or shower door does not hit the unit when opened.
- Ensure the minimum distance from the wall to the center of the floor drain is 305mm or 12inches long.



- The smart toilet accessories have been debugged and are strictly prohibited to be disassembled without permission.
- Please use the accessories,special angle valves and braided hoses provided by our company.Old fittings and hoses cannot be reused.

## 02.installation space measurement

- Confirm that the cold water inlet is equipped with the connection angle valve of the water supply braided hose.
- A safety grounded socket with faulty circuit breaker.

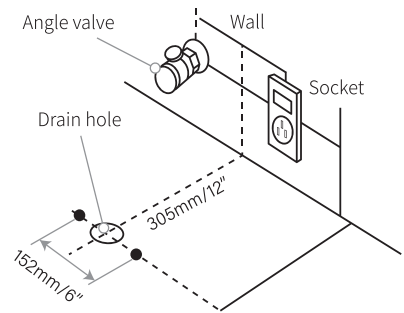



## 03.Water pressure requirements

- Minimum water pressure required:0.15MPa(1.5Kg/cm<sup>2</sup>)  
Water pressure flow rate is greater than 20L or 5.3gallons per minute.
- Maximum water pressure requirements:  
Less than or equal to 0.75MPa(7.5Kg/cm<sup>2</sup>)
- If the water pressure does not reach this level,the smart toilet may not work properly.

Check the water pressure:

Open the valve and let water enter the bucket for 15 seconds.If the water in the bucket exceeds 4L,the minimum water pressure is reached.

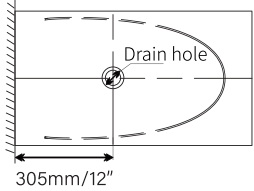
## 04. Installation steps diagram

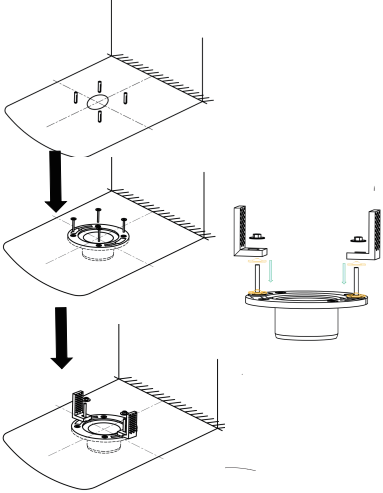
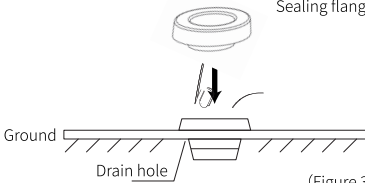
Operation steps	Diagram
<p>1) Installation steps:</p> <ul style="list-style-type: none"> <li>• For bathrooms with newly installed toilets, users need to confirm that the drain hole is equipped with a flange as shown in Figure 1 on the right.</li> <li>• Align the installation cardboard with the drain hole, with the rear of the cardboard parallel to the wall, draw a circle along the perimeter of the cardboard with a marker, and then take out the cardboard, as shown in Figure 1 on the right.</li> </ul>	 <p>(Figure 1)</p>
<p>• Use 4 sets of expansion screw components to fix the flange at the position of the drain pipe outlet. The installation steps are shown in the left diagram. It is shown in Figure 2.</p> <p></p> <p>The surface of the flange is level with the ground or slightly lower than the ground</p>	
<p>3) Install the flange and sludge sealing ring corresponding to the drain hole. Install the flange sealing ring on the floor drain hole and seal it well, as shown in the Figure 3 on the right.</p>	<p>Special oil sludge for sewage outlet</p> <p>Sealing flange</p>  <p>(Figure 3)</p>

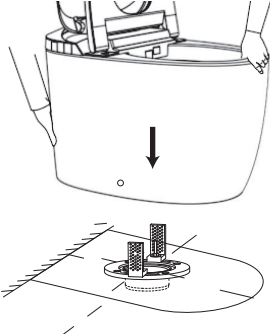
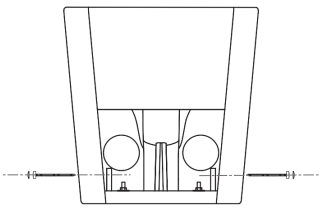
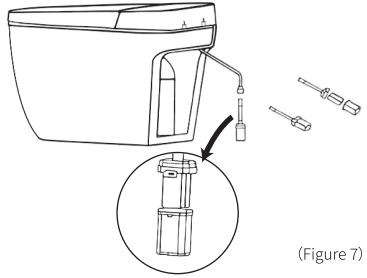
Operation steps	Diagram
<p>4) Place the ceramic drain hole correctly on the center line of the flange sealing ring hole.</p> <p>With the toilet on top, make sure that the anchor bolts fixing the ceramic are aligned with the hole on the toilet, as shown in Figure 4 on the right.</p> <p><b>NOTE:</b> Carefully install the flange seal on the drain hole.</p>	 <p>(Figure 4)</p>
<p>5) Use a wrench to tighten the nuts and other accessories that fix the anchor bolts. Fasten the ceramic to the mounting base plate, as shown in Figure 5 on the right.</p>	 <p>(Figure 5)</p>
<p><b>NOTE:</b></p> <p>BEFORE THIS INSTALLATION, THE 9V ALKALINE DRY BATTERY NEEDS TO BE EFFECTIVELY CONNECTED TO THE EXPOSED BATTERY CABLE PLUG OF THE UPPER COVER DEVICE.</p> <p>THE SPECIFIC STEPS ARE AS FOLLOWS:</p> <p><b>Battery installation steps:</b></p> <p>(Applicable to power outage and power failures flushing functions.)</p> <p>1) As shown in Figure 7 on the right, find the battery connection cable and battery box.</p> <p>2) Insert a new 9V alkaline dry battery into battery cover in the direction of arrow shown on the right, then install</p>	 <p>(Figure 7)</p>

Operation steps	Diagram
<p>it into the sealed and waterproof battery box,make sure it is secure,and place it in an appropriate position on the back of the ceramic for easy removal.</p> <p>3) Short press the knob to make sure it flushes correctly .</p>	

**Battery (consumables) usage specifications**

During the use of the smart toilet,the electrolyte of the battery will leak.Since the electrolyte contains the corrosive alkaline substance potassium hydroxide,it is harmful to the eyes and can irritate the eyes, respiratory tract and skin. It can also corrode and damage electronic components,affecting the use of the remote controller.

**⚠ NOTE:**Please check the battery box regularly. When the battery power is low,the battery needs to be replaced in time.

- Do not charge alkaline batteries.Charging alkaline batteries may cause the alkaline battery electrolyte to leak,or cause the alkaline battery to rupture or explode.
- If the battery is exhausted and needs to be replaced,please use batteries of the same model and specifications,otherwise the risk of electrolyte leakage will increase.
- When not in use for a long time ,the battery should be removed and stored separately to avoid electrolyte leakage and functional damage caused by long-term storage.
- Pay attention to the positive and negative polarity of the battery to prevent incorrect installation.
- Do not short circuit ,heat ,place the battery in a fire or attempt to disassemble the battery.

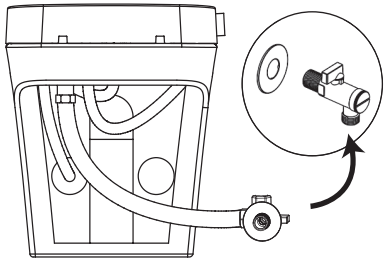
Operation steps	Diagram
<p>7)Install the water inlet angle valve and connect the special hose(before connecting the special hose,please drain the hose for 3-5 minutes to ensure that the water quality of the pipe is clean and the pipe is not blocked.</p>	

## 05. Waterway interface installation and maintenance

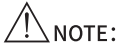

### NOTE:

- This device must use the special angle valve and braided hose provided by our company, otherwise the sewage discharge effect will be affected.
- The angle valve is equipped with a special filter to filter coarse impurities in the water, and the filter impurities are cleaned regularly every 3 months.

### Operation steps

The main process is as follows:

(As shown in Figure 8 on the right)

- Open the angle valve and drain the water for 3-5 minutes to prevent impurities in the water from clogging the filter and pipelines.
- Turn off the water supply by turning the angle valve.
- Connect the angle valve to the hexagonal braided hose nut of the complete machine.
- Open the angle valve and check whether there is water leakage at the connection between the braided hose and the angle valve.

### Diagram

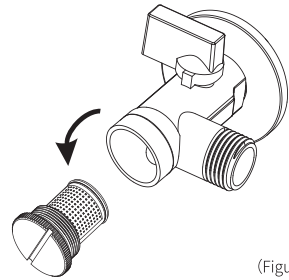

(Figure 8)

Precautions:

- The filter should be cleaned with clean water every three to four months.
- Steps to clean the filter: close the valve, unscrew the filter, and rinse carefully with clean water.
- Hoses and valves may differ from the above picture due to production batches, please refer to the actual product.

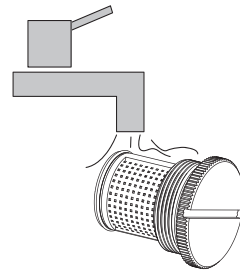

## 06. Ceramic bottom and floor sealing installation

Seal the gap between the toilet and the floor to further prevent water and odor leakage.

Apply a layer of general-purpose sealant (not included with the machine), evenly around the bottom of the ceramic, and smooth the sealant evenly with your fingers.

Allow the sealant to dry for at least 24 hours. (Follow the instructions for the specific sealant used during installation.) See Figure 9 on the right.

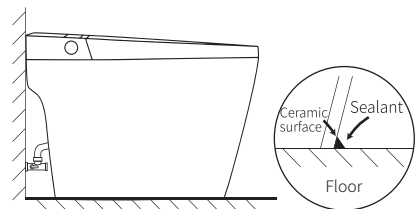

Diagram

(Figure 9)

## 07.Connecting the leakage protection power cord

- The power cord must be connected to an AC110-120V~60Hz , 16A+ grounded GFCI (ground fault circuit interrupter) power outlet.
- After connecting,wait for the product to complete its self-test .It is normal for users to see the side button flashing blue,the nozzle extending,the machine operating and buzzing.
- After the user self-test is completed ,a trial run should be performed.
- **WARNING:** Risk of electric shock -Connect only to a circuit that is protected by a ground-fault circuit-inter-rupter (GFCI)

### WARNING:

(1) Users are strictly prohibited from replacing or repairing damaged wires on their own. Otherwise, all consequences arising from this shall be borne by the user at full risk and responsibility.

(2) This product is not allowed to use extension cords on its own. If it is necessary to use it, please ask professional after-sales technicians for maintenance.

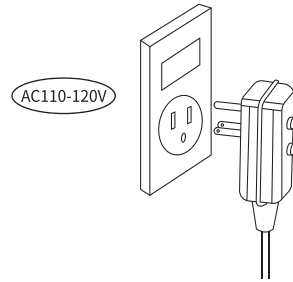

### Grounding Methods

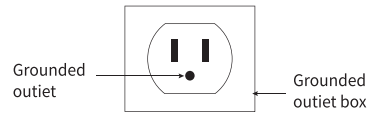

## VI.Checklist and test running





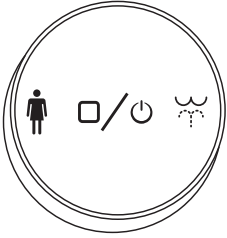
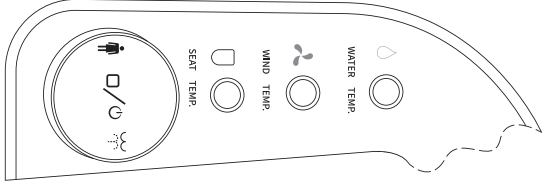

- (1) The power plug is firmly connected to a grounded 110-120V~60Hz,16A GFCI power supply.
- (2) The water inlet valve is open.
- (3) All connection points are securely fastened.
- (4) There is no leakage at the pipe joints and product.
- (5) The power light on the product turns on.
- (6) Use the remote controller and side knobs to confirm all functions(place one hand on the sensor area on the seat to activate certain cleaning functions of the product,place a hand on the seat .Place a piece of plastic between the toilet bowl and the seat to prevent water from spraying out of the nozzle),confirm that the following functions of the product are working properly.

- Rear washing and Female washing
- Water temperature
- Water pressure
- Nozzle position adjusting
- Nozzle self-clean
- Dryer heating
- Wind temperature
- Seat temperature
- Flushing
- Auto open/close cover and seat
- Foot-touched
- Digital screen functions display

 **Note:** For safety reasons,a trial run is necessary,if any failure occurs,please contact your dealer.

## 01. Machine knob/button function introduction





Diagram		
	TD-BM668A, TD-BM668B	TD-BM669A, TD-BM669B



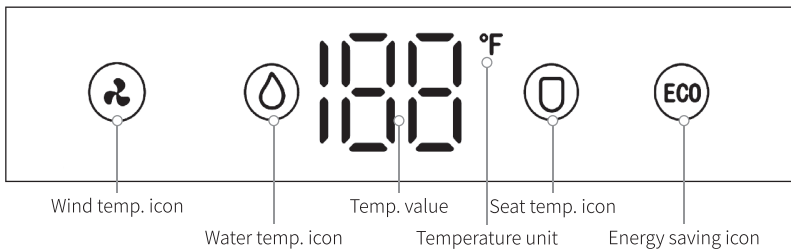

						
Stop	Female washing	Rear washing	Turn on	Water temperature	Wind temperature	Seat temperature
Flush	Nozzle reciprocating		Turn off			
Drying						

## 02. Functional overview

Main functions	<ul style="list-style-type: none"> <li>• Rear washin</li> <li>• Female washing</li> <li>• Nozzle</li> <li>• Nozzle self-clean</li> <li>• Pre flush before use</li> </ul>	<ul style="list-style-type: none"> <li>• High temperature protection</li> <li>• Flame-retardant protection</li> <li>• Soft-close cover/seat</li> <li>• Flame-retardant material</li> <li>• Pressure resistant seat</li> <li>• Energy saving</li> <li>• IPX4 Water proof</li> <li>• Flushing during power outage</li> <li>• Power off memory</li> </ul>	<ul style="list-style-type: none"> <li>• Warm wind drying</li> <li>• Water temperature adjustable</li> <li>• Seat temperature adjustable</li> <li>• Wind temperature adjustable</li> <li>• Nozzle adjustable</li> <li>• Night light</li> <li>• Remote control/Foot touched flush</li> <li>• Auto flush</li> <li>• Large flush</li> <li>• Small flush</li> </ul>
	Digital display functions introduce	(optional function,subject to actual product)	



Digital display functions introduce	<p><b>Display function icon description:</b></p> <ul style="list-style-type: none"> <li>When the whole machine is powered on and initialized,all the icons on the display will be turned on and the number will be "188".Flashes for 3 seconds,then all lights up.When initialization is completed,the seat temperature icon and seat temperature will be displayed.</li> <li>In standby mode,the seat temperature icon and temperature value will be displayed,but other icons will not light up.</li> <li>When using a function of this product,only the icon and value of the currently used function are displayed.</li> </ul> <p>For example: when using the cleaning function,only the water temperature icon and temperature value are displayed.</p> <p>After cleaning,only the seat temperature icon and temperature value are displayed.</p> <ul style="list-style-type: none"> <li>During the use of the whole machine,if the equipment fails,the display will only show the fault code. The Fahrenheit (°F) icon will not light up.</li> <li>ECO: In energy-saving mode,only the energy-saving icon is displayed,and the other default icons are turned off.But it usually lights up when entering other functional modes.</li> </ul>	
Side knob operation definition	When the user sits on the seat and uses it	
	<ul style="list-style-type: none"> <li>Turn the knob clockwise to start cleaning the rear.The normal cleaning time is 100 seconds.Turn the knob clockwise again within 100 seconds to start the nozzle moving forward and backward for cleaning.Rotate it clockwise again to stop the nozzle moving cleaning.</li> <li>When the rear cleaning is completed,the device will start warm air drying for 230 seconds by default.</li> <li>During the rear washing process,press the "Stop" button to end the rear cleaning.</li> </ul>	
	<ul style="list-style-type: none"> <li>Turn the knob counterclockwise to start female cleaning.The normal cleaning time is 100 seconds.Within 100 seconds,turn the knob counterclockwise again to start the nozzle moving forward and backward for cleaning.Rotate it counterclockwise again to stop the nozzle moving cleaning.</li> <li>When the female cleaning is completed,the device will start warm air drying for 230 seconds by default.</li> <li>During the female washing process,press the "Stop" button to end the female cleaning.</li> </ul>	
	<ul style="list-style-type: none"> <li>When other functions are being executed ,press this button once to stop the function being executed.</li> <li>When the seat ring sensor is valid and the cleaning function is not executed,short pressing the middle button of the knob once can execute the drying function,but the flushing function cannot be executed.</li> </ul> <p>Note:If the power cord of the whole machine is not connected to the power socket,please press and hold the button to start manual dry battery flushing. (The service life of a dry battery is about 100 times.If the user encounters problems when replacing the battery,support for more help.)</p>	
 <small>WATER TEMP</small>	<p>When the machine performs the cleaning function,each time press this circular button,the water temperature level increase by one level,and the buzzer sounds corresponding to the gear level (one time beep for the first level 93°F,two beeps for the second level 98°F, and three beeps for the third level 102°F). Normal temperature setting(water supply temperature)with a long beep.) At the same time the value on the display flashes three times and then stabilizes at the current gear value. Each time you press it,the gears cycle through 1-2-3-0-1-2-3.</p>	

When the user sits on the seat and uses it	
	<p>When the machine performs the drying function,each time you press this circular button,the air temperature will increase by one level,and the buzzer will sound corresponding to the gear (first beep for 113°F,second beep for 122°F,and third beep for 131°F setting and one long beep for the normal temperature setting. At the same time,the value on the display flashes three times and then stabilizes at the current gear value. Each time you press it,the gears cycle through 1-2-3-0-1-2-3.</p>
	<p>When the user adjusts the seat ring temperature levels,each time press the circular button is pressed,the seat temperature level increases by one level and the buzzer sounds corresponding to the gear level ( first beep for the first level 93°F,second beep for the second level 98°F,and third beep for the third level 102°F,and one long beep for normal temperature setting.) At the same time,the value on the display flashes three times and then stabilizes at the current gear value.Each time you press it,the gears cycle through 1-2-3-0-1-2-3.</p>
When the user is not sitting on the seat	
	<ul style="list-style-type: none"> <li>• When the knob is rotated clockwise for 1 second,the command is invalid.</li> <li>• Turn clockwise to position and hold for 5 seconds to turn the pre flush function(wetting ceramic wall) on or off .</li> <li>• The command is invalid when turning the knob counterclockwise.</li> </ul>
	<ul style="list-style-type: none"> <li>• When the leakage protection power supply is successfully plugged into the power socket,and the human body is not sitting in the position of the seat sensor or the sensor is in an invalid state,press the center of the knob for 3 seconds to turn off or turn on the power of the whole machine ,and the buzzer will sound for a long time.</li> <li>• Short press the middle part of the knob to flush one time,with corresponding to one time beep.</li> </ul>
Foot-touched function introduce	
	<p><b>TD-BM668B、TD-BM669B :Instructions for the function of the foot-touched switch when the flip-up function is available:</b></p> <p>When the product' s seat cover and seat ring are closed.The user taps the button with his or her foot to open the cover ; taps the button again to ope the seat ring ;taps it again to close the seat ring and seat cover,and then performs the flushing function.(the buzzer beeps)</p> <ul style="list-style-type: none"> <li>• When the seat cover is open and the seat is closed:</li> </ul> <p>When not seated, the user taps the button with their foot to open the seat;taps it again to close the seat ring and and seat cover ,and then performs the flushing function.(the buzzer beeps).</p> <ul style="list-style-type: none"> <li>• When both the seat ring and seat cover are open.The user taps the button with his/her foot,and the product performs the flushing function after closing the seat ring and seat cover. (The buzzer beeps.)</li> <li>• When the seat sensor is in an effective state,the user taps the button with his/her foot,the flushing function is disabled,and the buzzer beep twice.</li> </ul> <p><b>TD-BM668A、TD-BM669A:Instructions for the function of the foot-touched switch when there is no the flip-up function:</b></p> <ul style="list-style-type: none"> <li>• When the seat cover and seat ring of the product are opened or closed at the same time,the user can taps the button with his/her foot to perform the flushing function.(the buzzer beeps.)</li> <li>• When there is a signal from the seat sensor,the user taps the button with his/her foot,the flushing function is disabled,and the buzzer beep twice.</li> </ul>

Side knob operation definition



## Remote control buttons and functions introduce

Icon

Function definition



**Stop function:**

Press one time to stop a running function and switch to standby mode.



**Rear cleaning:** Available to use when the user is sitting on the device and the seat sensor is effectively covered.

During the cleaning process, press it again within 100 seconds to start the nozzle moving back and forth for cleaning, and press it again to stop the nozzle movement. Each time the button is pressed, a command will be issued and the buzzer will sound once.



**Female cleaning:** Available to use when the user is sitting on the device and the seat sensor is effectively covered.

During the cleaning process, press it again within 100 seconds to start the nozzle moving back and forth for cleaning, and press it again to stop the nozzle movement. Each time the button is pressed, a command will be issued and the buzzer will sound once.



**Warm air drying/night light switch:** Available to use when the user is sitting on the device and the seat sensor is effectively covered.

- Short press this button to start warm air drying, the normal drying time is 230 seconds, and the corresponding indicator light will display the current temperature setting.

Press the wind and temperature button to switch temperature setting. The display on the device will show the current wind temperature value.

- Long press this button for 3 seconds to turn on the night light, and long press it again for 3 seconds to turn off the night light. Night light is blue.







**Flush function:**



Perform flushing by doing the following:



- Short press the **[FLUSH]** button on the remote controller for 0.5 seconds to perform flushing. When flushing, the buzzer will sound a buzzer.
- Short press the middle button of the knob for 0.5 seconds to perform flushing. A large flush will occur, and the buzzer will sound.
- Taps the foot-touched button one time, small flushing is performed and corresponding with a beep.

Automatic flushing:

- Automatic flush setting: Automatic flushing is enabled by default when leaving the seat position.
- Automatic flushing action: When the human body is seated on the seat ring and the seat sensing is covered, and the buzzer sounds, and the upper track of the ceramic inner wall is moisturized and flushed for 1.2 seconds. When human body leaves the seat sensing position of the seat, the buzzer will sound and the system will flush once (a small flush will be performed within 5-30 seconds of leaving the seat, and a large flush will be executed after more than 30 seconds.)
- After the device is powered off, it will automatically connect to the battery for power supply (only used for flushing function). Long press the flush button for 3 seconds, the knob ambient light will light up, and corresponding a beep, and the system will activate the power-off flushing function.

Icon	Function definition
	<p><b>Remote control to open seat cover function:</b></p> <p>When the seat cover is closed ,press once top open the seat cover and press again to close the seat cover.</p> <p>When opening the seat cover,press once to close the seat cover,press again to open the seat cover,and cycle in sequence.When the seat cover and seat right are open,press once to close the seat ring and seat cover.</p> <p>Press “Stop+Open cover “ on the remote controller at the same time for 5 seconds to switch the seat cover to invalid mode.The buzzer will beep 1 short time to turn on,and 2 short beeps to turn it off.</p>
	<p><b>Remote control to open seat ring function:</b></p> <p>When the seat cover and seat ring are closed,press once to open the seat cover and seat ring,and press again to close the seat ring.When the seat cover is open and the seat ring is closed,press once to open the seat ring and again to close the seat ring.When the seat cover and seat ring are open,press once to close the seat and again to open the seat.</p> <p>Press “Stop+Open seat “ on the remote controller at the same time for 5 seconds to switch the seat cover to invalid mode.The buzzer will beep 1 short time to turn on,and 2 short beeps to turn it off.</p>
	<p><b>Nozzle position adjustment:</b></p> <ul style="list-style-type: none"> <li>• In cleaning mode,press the <b>▼</b> or <b>▲</b> button to control the nozzle position.The nozzle has a total of 5 positions .The first gear represents the minimum position of the nozzle , and fifth gear represents the maximum position of the nozzle.</li> <li>• The adjustment distance of the spray rod position is different during rear cleaning and female cleaning.The rear cleaning distance is adjusted by about 10mm for each gear , and for women , it is adjusted by about 15mm.</li> <li>• During the cleaning process,users can adjust the appropriate position through two buttons according to the different cleaning areas to meet their own cleaning needs.</li> <li>• Each time the button is pressed,a command is issued and the buzzer responds with a beep.If the buzzer sounds twice , it means the command is invalid and the current function will not be executed.</li> <li>• The cleaning pipe position is in level 5,press <b>▲</b>,the position will increase by one,and it will not change after reaching level 5.Press <b>▼</b> to decrease the position by one level,and it will not change when reaching the level 1.The single-tone recognition command of the buzzer is valid,but the dual-tone recognition command is invalid.</li> </ul>
	<p><b>Nozzle self-cleaning function:</b></p> <p>Short press the self-cleaning button for 0.5 seconds to turn on the self-cleaning function,extend the spray rod,and start running the self-cleaning nozzle function,which will end after 120 seconds.During the self-cleaning process,press the nozzle self-cleaning button and stop button at the same time to stop self-cleaning.</p> <p><b>Energy saving:</b></p> <p>Short press the ECO button on the remote controller to turn on/off the energy-saving function,which emits one beep when on and two beeps when off. In energy-saving mode,when no one is seated,the seat temperature will be set to 77°F even if it is not in 0 level.</p> <p>After not pressing the ECO button on the remote controller and not sitting on the seat for 30 minutes,the machine automatically enters the energy-saving state and the seat temperature automatically drops to 77°F.When the seat sensor is activated,rotate the side knob or pressing any button on the remote controller to automatically return to the setting level.</p>

Icon	Function definition
	<p><b>Washing intensity adjustment:</b>  Press the increase or decrease button to adjust water pressure between water pressure setting. Each time press the <b>[+]</b> button to increase the water pressure level by one ,until to the maximum value.  Each time press the <b>[-]</b> button to decrease the water pressure level by one,until to the minimum value.  The water flow rate of the first level is 0.4 liters/minute or 0.107gallons/minute.  The water flow rate of the second level is 0.46 liters/minute or 0.123 gallons/minute.  The water flow rate of the third level is 0.52 liters/minute or 0.139 gallons/minute.</p> <ul style="list-style-type: none"> <li>• When pressing the cleaning intensity button,the water pressure flow value needs to change synchronously.</li> <li>• The water pressure is set to 3 levels.</li> </ul> <p>Each time pressing <b>[+]</b> will increase one level,and the water flow rate will not change after pressing "+" to third level.  Each time pressing <b>[-]</b> will decrease one level,and the water flow rate will not change after pressing "-" to first level.  The buzzer beeps once to indicate that the command is valid,and to beeps twice to indicate that the command is invalid.</p>
	<p><b>Water temperature adjustment:</b>  Short press the <b>[Water temp.]</b> button on the remote controller to adjust the water temperature for washing. Each time press it,temperature levels will be changed and the buzzer will sound one beep.Follow he 0-1-2-3-0-1-2-3 cycle setting.  The first level of seat temperature,the corresponding indicator light color is white,93°F,and the buzzer sounds one beep.  The second level of seat temperature,the corresponding indicator light color is white,98°F,and the buzzer beeps twice.  The third level of seat temperature,the corresponding indicator light color is white,102°F,and the buzzer beeps three times.  When the water temperature is at normal temperature,indicating the water temperature in the water supply pipe,the corresponding indicator light goes out and the buzzer sounds a long beep. After the above command takes effect,the display will simultaneously display the current water temperature icon and value.</p>
	<p><b>Seat ring temperature adjustment:</b>  Short press the <b>[Seat Temp.]</b> button on the remote control to adjust the heating temperature.Each time press it to change to the corresponding temperature level with one beep .Follow the 0-1-2-3-0-1-2-3.  The first level of seat temperature,the corresponding indicator light color is white,93°F,and the buzzer sounds one beep.  The second level of seat temperature,the corresponding indicator light color is white,98°F,and the buzzer beeps twice.  The third level of seat temperature,the corresponding indicator light color is white,102°F,and the buzzer beeps three times.  When the seat ring temperature is normal,it means that the seat ring heating function is turned off,the corresponding indicator light goes out,and the buzzer sounds a long beep. After the above command takes effect,the display screen simultaneously displays the current seat ring temperature icon and value.</p>

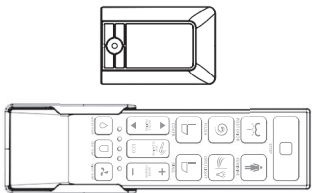
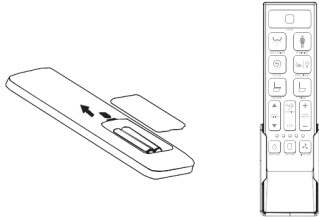
Remote controller operation instructions	Icon	Function definition
		<p><b>Warm wind temperature adjustment:</b>  Short press the【Wind temp.】 button on the remote control to adjust the heating temperature. Each time press it to change to the corresponding temperature level with one beep. According to 0-1-2-3-0-1-2-3.  The first level of wind temperature, the corresponding indicator light color is white, 45°C or 113°F, with one beep.  When the wind temperature is at normal temperature, it indicates that the air temperature is the ambient temperature inside the machine, the indicator light goes out and the buzzer sounds a long beep.  After the above command takes effect, the display will simultaneously display the current air temperature icon and value.</p>
	○ ○ ○ ○ ○	<p><b>Levels indicator light definition:</b>  In the first level, one indicator light on the remote controller is light up, white.  In the second level, two indicator lights on the remote controller are light up, white.  In the third level, three indicator lights on the remote controller are light up, white.  In the fourth level, four indicator lights on the remote controller are light up, white.  The fifth level, five indicator lights on the remote controller are light up, white.</p>
 Remote control troubleshooting		
<p><b>If the remote control does not respond:</b></p> <p>(1) Check whether the battery is discharged, replace the battery and power on the remote controller.</p> <p>(2) If the light on the remote control responds but the toilet does not, the connection between the remote control and this smart toilet may have been accidentally disconnected. Please follow these steps:</p> <ul style="list-style-type: none"> <li>• Open the battery back cover of the remote control and replace it with 2 new 1.5V/AAA alkaline dry batteries.</li> <li>• Disconnect this smart toilet from the power socket.</li> <li>• Please operate according to the code matching method between the remote control and the smart toilet.</li> <li>• After the remote control successfully matches the code of this smart toilet, use the remote control to perform a functional test on the smart toilet.</li> </ul>		
Remote controller installation	<p><b>Install the remote controller:</b></p> <p>(1) Use the double-sided tape on the back of the bracket to stick the bracket on the wall (the wall needs to be cleaned before sticking).</p> <p>(2) Place the remote control on the bracket.</p>	
	<p><b>Remote controller battery installation:</b></p> <p>(1) Insert the battery into the remote controller. Pay attention to the direction of the positive and negative poles of the batteries.</p> <p>(2) Place the remote controller on the stand.</p>	

 **NOTE:**

- (1) When someone is sitting in the seat, please make sure the remote controller is within reach.
- (2) Do not install and use this product in wet places such as shower room.
- (3) Do not place the product where it is easily exposed to water.

### 03.Trial run of the whole machine

- (1) After turning on the power, the buzzer will beep and the knob light will light up blue. All icons on the display light up and the self-test begins.
- (2) The buzzer sounds again and the self-test is completed. The knob light lights up blue. The wind temperature, water temperature and ECO icons go out and take a seat.
- (3) The temperature icon is lights up, indicates that the product is ready for use.

 **NOTE: Seat cover/seat ring automatic open/close function only applies to :**

- Products with seat cover, seat ring automatic open/close function (TD-BM668B, TD-BM669B).
- With the cover closed, please use the remote control to automatically open/close the seat cover.

#### Approaching to the toilet:

When the user enters the toilet sensing range, the seat cover will automatically open by using the open cover/seat button on the remote control or foot-touched function.

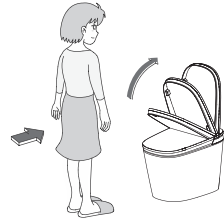

#### Leaving the toilet:

The seat cover automatically closes 300 seconds after the user leaves.

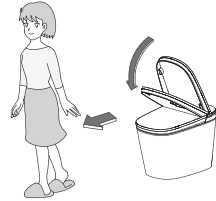

#### Men pee:

- Use the remote control or taps the foot-touch button to open seat cover or seat ring.
- The seat ring and seat cover automatically close 300 seconds after the user leaves.

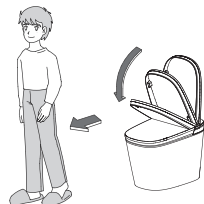

If the model you purchased has a foot-touch button, you can use the foot-touch button to control the following functions:

When the seat cover and seat ring are closed, touch the button with your foot to open the seat cover.



When the seat cover is open and the seat ring is closed, tap the button to open the seat ring.



When the seat ring and cover are open, use the foot-touch function to close seat ring and seat cover and small flush automatically.  
Or automatically close the seat ring and seat cover after 300 seconds of leaving.



## VII.Maintenance

### Regular maintenance

#### Cleaning equipment:

Use a dry,soft cloth or sponge to gently wipe away dirt and stains.Do not apply any chemical solutions to the equipment.

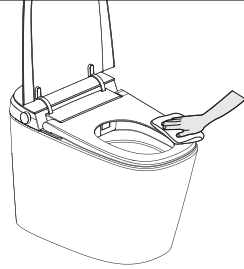

#### Cleaning nozzle:

- The User cannot sit on the seat.
- Nozzle self-cleaning function.

Short press the "Nozzle self-clean" button on the remote controller for 0.5 seconds to turn on the nozzle self-cleaning function,extend the spray rod,turn the distribution valve to the self-cleaning port,open the constant pressure valve,set the water temperature to the maximum level,and end after 120 seconds.During the self-cleaning process,press the self-cleaning /stop button at the same time to stop self-cleaning.

#### WARNING:

Do not pull,push or attempt to bend the nozzle as this may cause damage or electric shock.

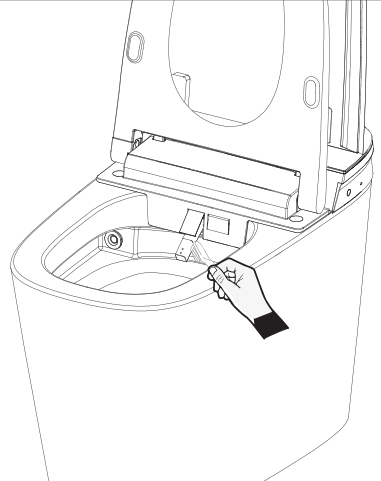

#### Clean filter:

- (1) Turn off the power of this product and unplug the leakage protection power cord with dry hands.
- (2) Use a tool to unscrew the filter if necessary.
- (3) Rinse with clean water.using a brush if necessary.
- (4) Put the filter back in place and check for leaks.

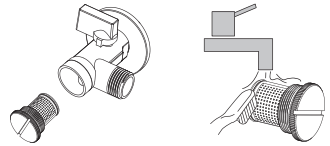

## VIII.Common troubleshooting

Fault diagnosis	Inspect	Solutions
The smart toilet cannot be started at all	Is there a power outage or the power socket is not connected.	Please confirm whether the power plug and switch are turned on
Smart toilet cannot flush	Is the water supply cut off or the water supply valve closed or the filter screen blocked?	Please check whether the water line and filter are normal
Poor sewage discharge	Is the sewage pipe blocked	Pour water into the ceramic bowl and check for siphoning
Leakage	Are the connection to the water supply pipe tightened	Please tighten the water supply pipe connection
Washing water temperature is low	Please confirm whether the water temperature has been adjusted to the normal temperature range.	Please readjust the water temperature
Seat ring surface temperature is low	Please confirm whether the seat ring temperature has been adjusted to the normal temperature range	Please readjust the seat ring temperature

 **NOTE:** If the above faults occur, please contact the supplier and professional after-sales technicians in the time to handle them.

## IX. Technical specification parameters

Items		Parameters			
		TD-BM668A	TD-BM668B	TD-BM669A	TD-BM669B
Rated Voltage		110-120V~, 50/60Hz			
Rated power		920 W			
Water heating mode		Instant heating			
Power cable length		0.9m(2.93ft)			
Waterproof level		IPX4			
Washing levels	Washing modes	Rear washing	Between 0.40-0.52L/min(between 0.11-0.139gal/min)		
		Female washing	Between 0.40-0.52L/min(between 0.11-0.139gal/min)		
	Water temperature 4 levels		Adjustable temperature range: Normal temp.~34°C~39°C (between 93°F~103°F)		
	Heater power(maximum)		1300W		
	Safety devices		Thermal fuse,water temperature sensor.temperature jumper		
Anti-backflow device		Vacuum breaker			
Warm wind drying	Warm wind temperature 4 levels		Adjustable temperature range: Normal temp.~45°C~55°C(between 113°F~131°F)		
	Wind speed		about 7.6m/s(between 1496Ft/min)		
	Drying heater power		300W±5%		
	Safety devices		Thermal fuse,bimetal thermometer		
Seat ring heating	Seat surface temperature 4 levels		Adjustable temperature range: Normal temp.~34°C~39°C(between 93°F~103°F)		
	Heater power		45W(+7% ~ -5%)		
	Safety device		Thermal fuse		
Water supply pressure		Minimum required water pressure:0.15MPa (21.8 Psi) <dynamic>, maximum required water pressure:0.75 MPa (108.75 Psi) <static>			
Water supply temperature		2°C~34°C(35.6°F~93°F)			
Working temperature		2°C~40°C(35.6°F~104°F)			
Dimensions		685mmx390mmx456mm(27"x 15.35"x17.95")			
Weight		Net: 37kg(81.6lbs.) Gross:45kg(99.2lbs)			

 **NOTE: The power measurement conditions of this machine are as follows:**

- The external water supply temperature is  $15\text{ }^{\circ}\text{C} \pm 1\text{ }^{\circ}\text{C}$  ( $\approx 59\text{ }^{\circ}\text{F}$ ), the ambient temperature is  $23\text{ }^{\circ}\text{C} \pm 1\text{ }^{\circ}\text{C}$  ( $\approx 73.4\text{ }^{\circ}\text{F}$ ), and the water pressure  $0.2 \pm 0.02\text{ MPa}$ .
- When turning on the machine, adjust the base temperature to the lowest setting and set the water temperature to the normal temperature range. After 30 minutes, set the water temperature level to highest temperature level, the leaning water pressure to the maximum level (i.e. The maximum cleaning flow rate), the seat ring temperature to the highest level, and start testing the 60-second average power after the water output from the nozzle has stabilized for 10 seconds.



