

ASSEMBLY INSTRUCTIONS

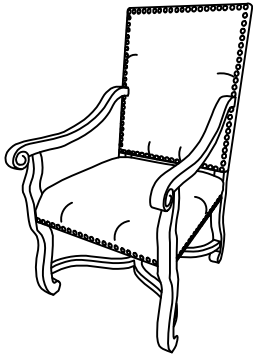

PARTS LIST

	DESCRIPTION	Q' ty
A	Chair Back	1
B	Seat Frame	1
C	Right Leg	1
D	Left Leg	1
E	Right Arm	1
F	Left Arm	1
G	Stretchers	1

HARDWARE LIST

NO.	DESCRIPTION	Q' ty
H	Screw $\Phi 5/16'' * 3-1/4'' L$	4
I	Screw $\Phi 5/16'' * 2-1/2'' L$	4
J	Screw $\Phi 5/16'' * 1-3/4'' L$	1
K	Screw $\Phi 1/4'' * 3/4'' L$	8
L	Screw $\Phi 1/4'' * 1-3/4'' L$	2
M	Flat Washer $\Phi 5/16'' * 19mm$	9
N	Lock Washer $\Phi 5/16''$	9
O	Flat Washer $\Phi 1/4'' * 16mm$	2
P	Lock Washer $\Phi 1/4''$	2
Q	Allen Wrench 5mm	1
R	Allen Wrench 4mm	1
S	Wood Screw $\#8 * 1-1/2'' L$	2
T	Connecting Metal $31 * 21 * 2mm$	4

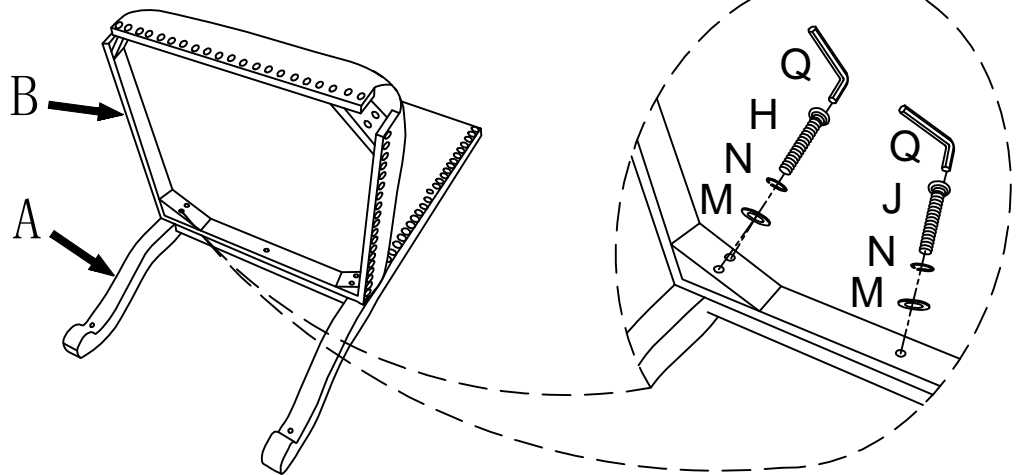



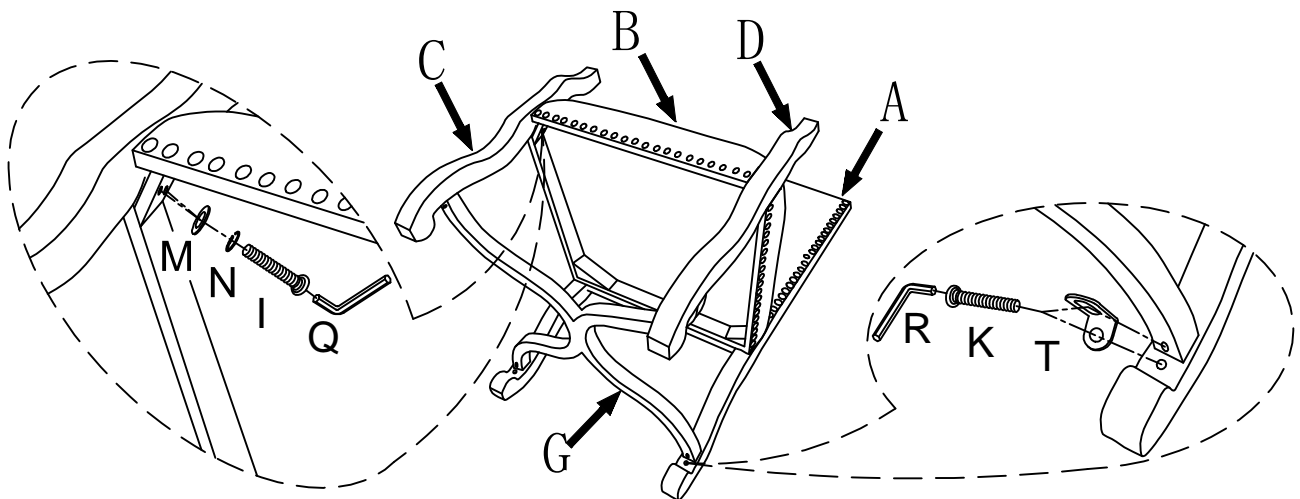

















STEP1



STEP2

Note:
Lock the round hole first and
then lock the elliptical hole !

ASSEMBLY INSTRUCTIONS

PARTS LIST				HARDWARE LIST				
	DESCRIPTION		Q' ty	NO.	DESCRIPTION		Q' ty	
A	Chair Back		1	H	Screw	$\Phi 5/16'' * 3-1/4''L$		4
B	Seat Frame		1	I	Screw	$\Phi 5/16'' * 2-1/2''L$		4
C	Right Leg		1	J	Screw	$\Phi 5/16'' * 1-3/4''L$		1
D	Left Leg		1	K	Screw	$\Phi 1/4'' * 3/4''L$		8
E	Right Arm		1	L	Screw	$\Phi 1/4'' * 1-3/4''L$		2
F	Left Arm		1	M	Flat Washer	$\Phi 5/16'' * 19mm$		9
G	Stretchers		1	N	Lock Washer	$\Phi 5/16''$		9
				O	Flat Washer	$\Phi 1/4'' * 16mm$		2
				P	Lock Washer	$\Phi 1/4''$		2
				Q	Allen Wrench	5mm		1
				R	Allen Wrench	4mm		1
				S	Wood Screw	#8*1-1/2''L		2
				T	Connecting Metal	31*21*2mm		4

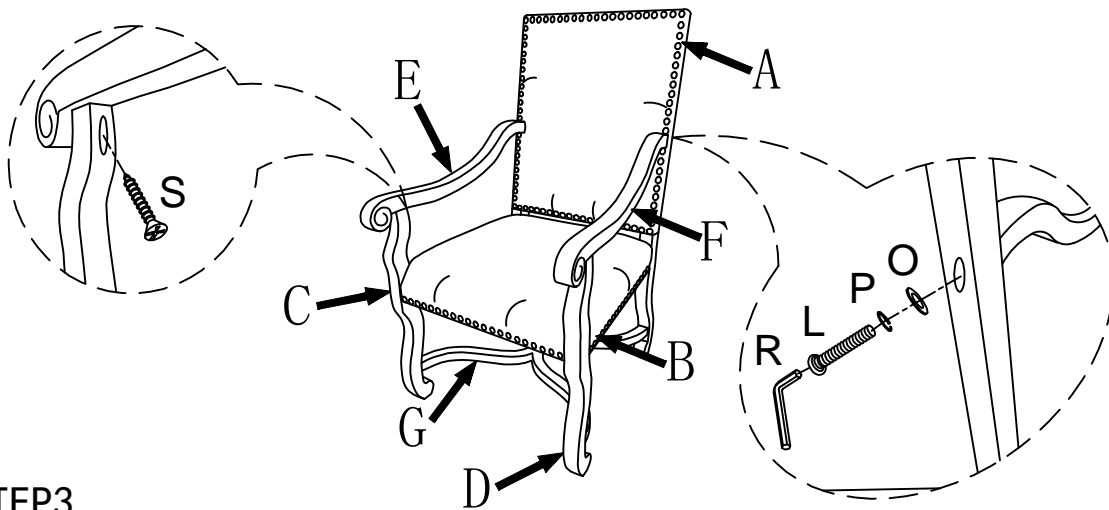
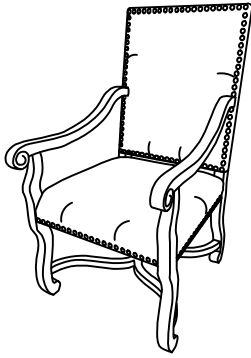

STEP3

Note:
Don't completely tighten
all bolt until uprighted
and leveled the chair !

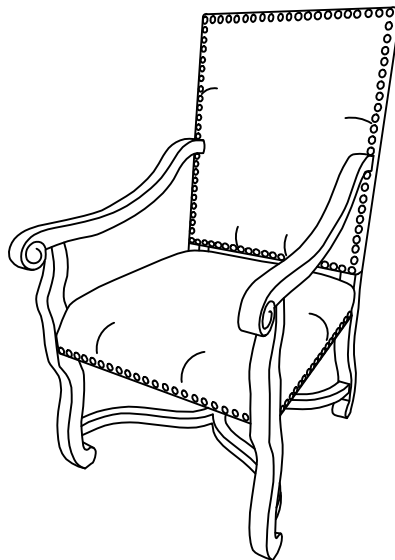

FINISH