





ASSEMBLY INSTRUCTIONS

FULL HEADBOARD WITH USB
 QUEEN HEADBOARD WITH USB
 KING HEADBOARD WITH USB
 CALKING HEADBOARD WITH USB

Thank you for purchasing this product. Please take time to read and follow the instructions below. Check that you have all parts and hardware before assembly. Parts apparently missing are often found in the packing materials. If you do not have all the parts listed, have your dealer contact us and they be sent to you immediately.

⚠ It is recommended to install protective pads under all legs and supports to avoid damage or scratches when placing furniture on a wood floor or other hard surface, and to limit indentation and prevent discoloration if placing on carpet.

HARDWARE LIST				
No.	Description	Sketch	Size	Quantity
1	Allen Bolt		Ø1/4" x 32mmL	8 PCS
2	Spring Washer		Ø1/4"	8 PCS
3	Flat Washer		Ø1/4" x 19mmL	8 PCS
4	Allen Key		4mmL	1 PC

PARTS LIST			
No.	Description	Sketch	Quantity
A	Headboard		1 PC
B	HB Leg - L&R		2 PCS

STEP 1 : Take the HB Leg (B) out of the inner box from the back of Headboard (A).

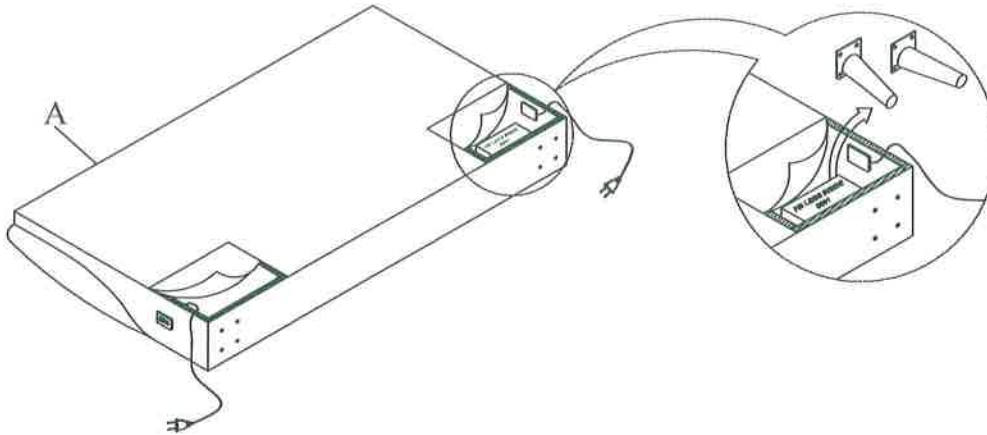

STEP 2 : Attach HB Leg(B) to Headboard(A) by using Allen Bolt(1), Spring Washer(2), Flat Washer(3) and Allen Key(4).

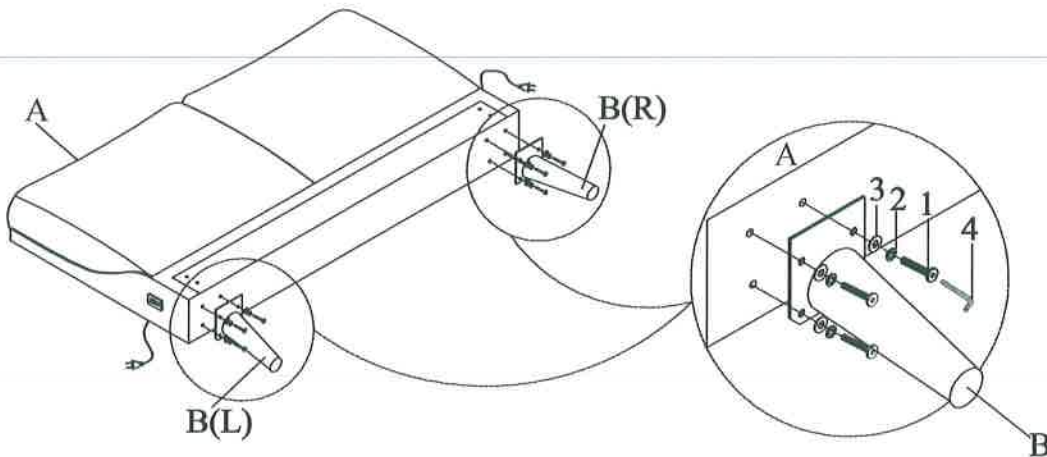









ASSEMBLY INSTRUCTIONS

CAL KING FOOTBOARD + RAILS









Thank you for purchasing this product. Please take time to read and follow the instructions below. Check that you have all parts and hardware before assembly. Parts apparently missing are often found in the packing materials. If you do not have all the parts listed, have your dealer contact us and they be sent to you immediately.

▲ It is recommended to install protective pads under all legs and supports to avoid damage or scratches when placing furniture on a wood floor or other hard surface, and to limit indentation and prevent discoloration if placing on carpet.

HARDWARE LIST

No.	Description	Sketch	Size	Quantity
1	Allen Bolt		Ø1/4" x 32mmL	8 PCS
2	Spring Washer		Ø1/4"	18 PCS
3	Flat Washer		Ø1/4" x 19mmL	8 PCS
4	Allen Bolt		Ø5/16" x 32mmL	8 PCS
5	Spring Washer		Ø5/16"	8 PCS
6	Flat Washer		Ø5/16" x 19mmL	8 PCS
7	Screw		#4 x 30mmL	26 PCS
8	Allen Key		4mmL	1 PC
9	Allen Bolt		Ø1/4" x 50mmL	10 PCS

PARTS LIST

No.	Description	Sketch	Quantity
A	Headboard		1 PC
B	Footboard		1 PC
C	Footboard Leg - L&R		2 PCS
D	Side Rail		2 PCS
E	Slat Roll		1 Set
F	Center Slat Support		1 PC
G	Support Leg		5 PCS
H	Cap Rail		2 PCS

STEP 1 : Attach FB Leg(C) to Footboard(B) by using Allen Bolt(1), Spring Washer(2), Flat Washer(3) and Allen Key(8).

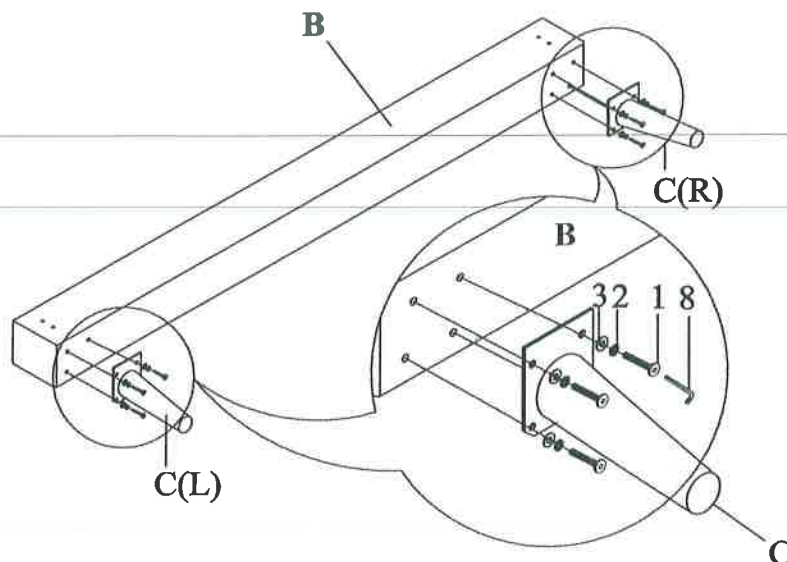

ASSEMBLY INSTRUCTIONS

CAL KING FOOTBOARD + RAILS

STEP 2 : Attached the Side Rail(D) to the Footboard(B) and Headboard(A) by using Allen Bolt(4), Spring Washer(5), Flat Washer(6) and Allen Key(8).

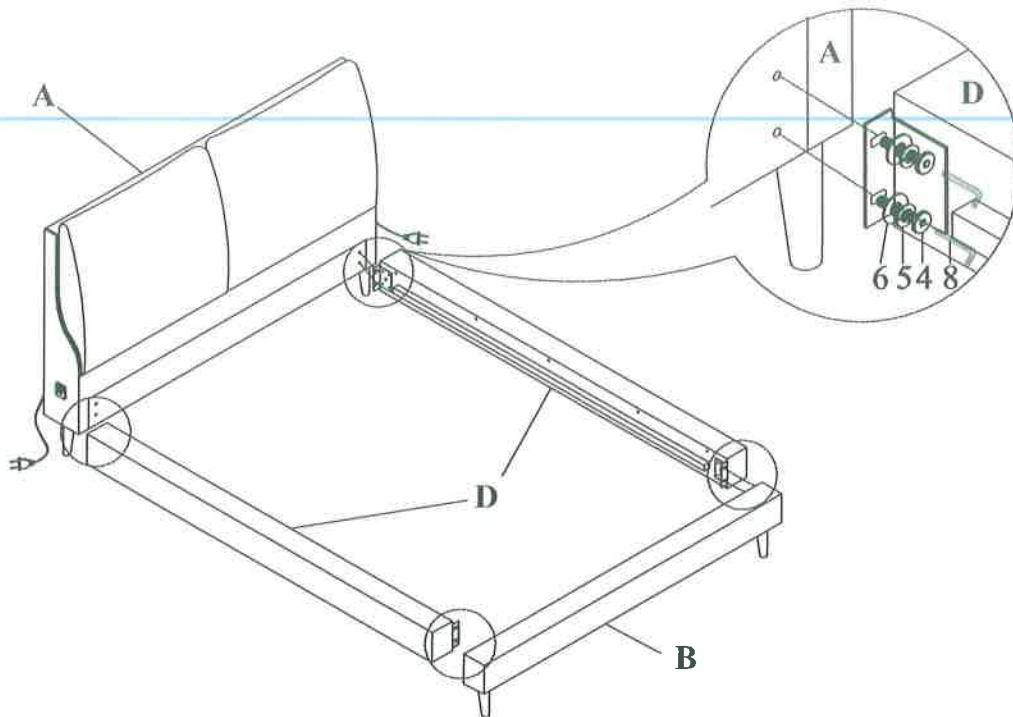

STEP 3 : Attach Support Leg(G) to Center Slat Support(F) and Slat Roll(E). Then place Slat Roll(E) on Side Rail(D) with Screw(7).

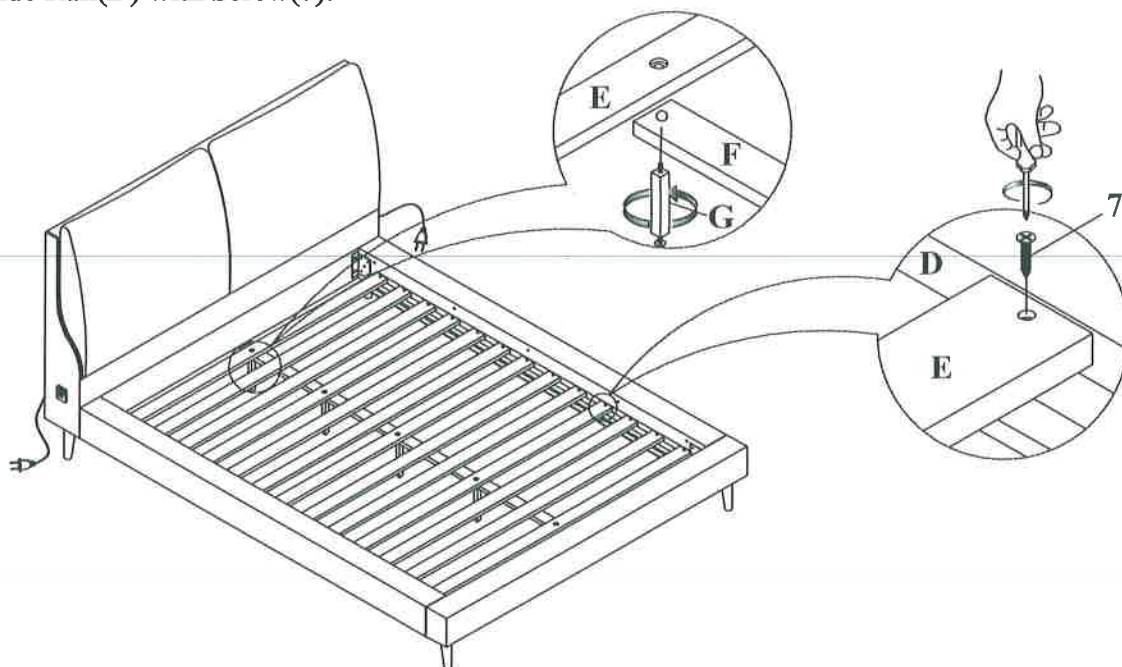

ASSEMBLY INSTRUCTIONS

CAL KING FOOTBOARD + RAILS

STEP 4: Attach Cap Rail(H) to Side Rail(D) by using Allen Bolt(9), Spring Washer(2), and Allen Key(8).

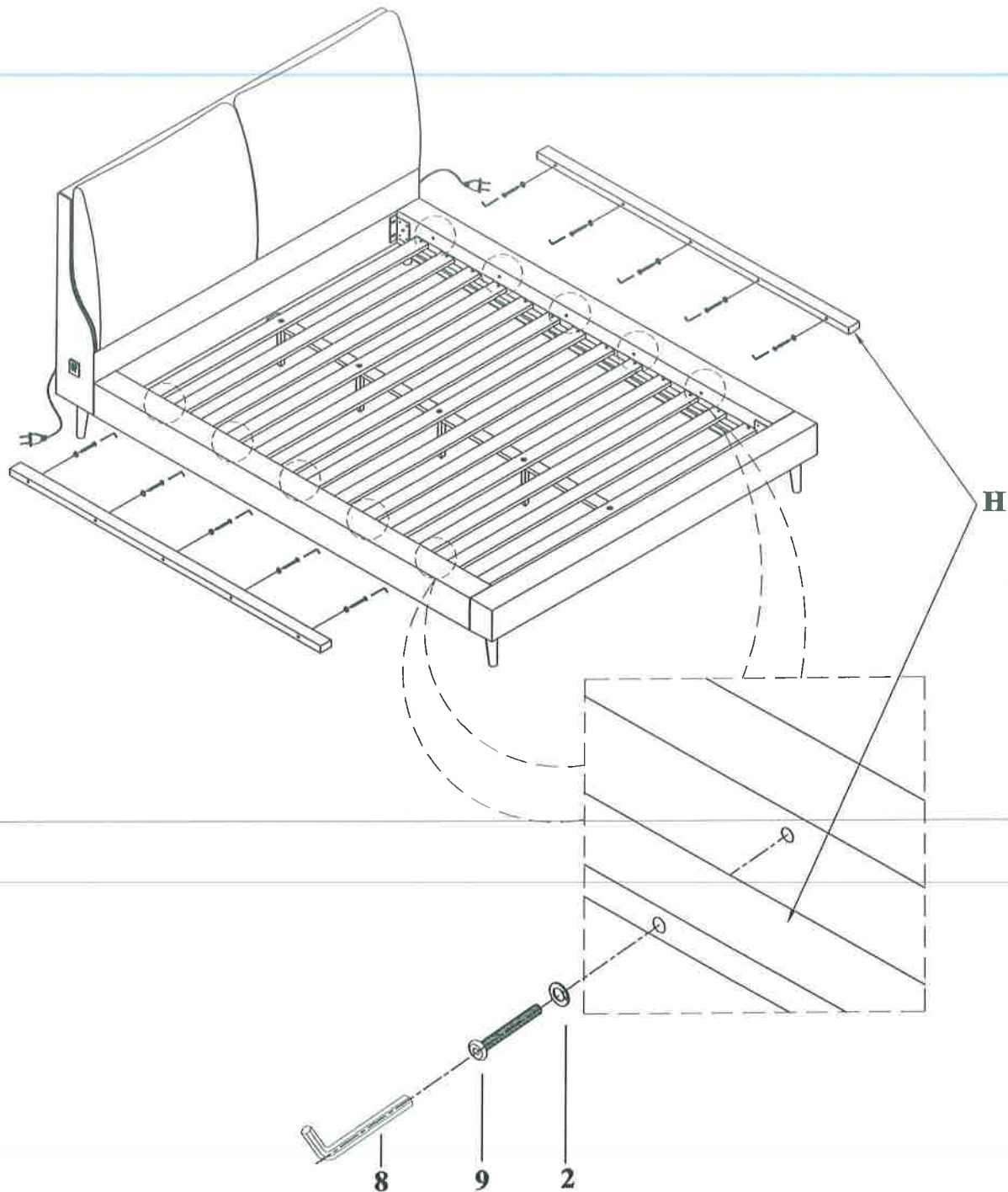

ASSEMBLY INSTRUCTIONS

CAL KING FOOTBOARD + RAILS

COMPLETE

