

6 Drawer Cabinet Instruction

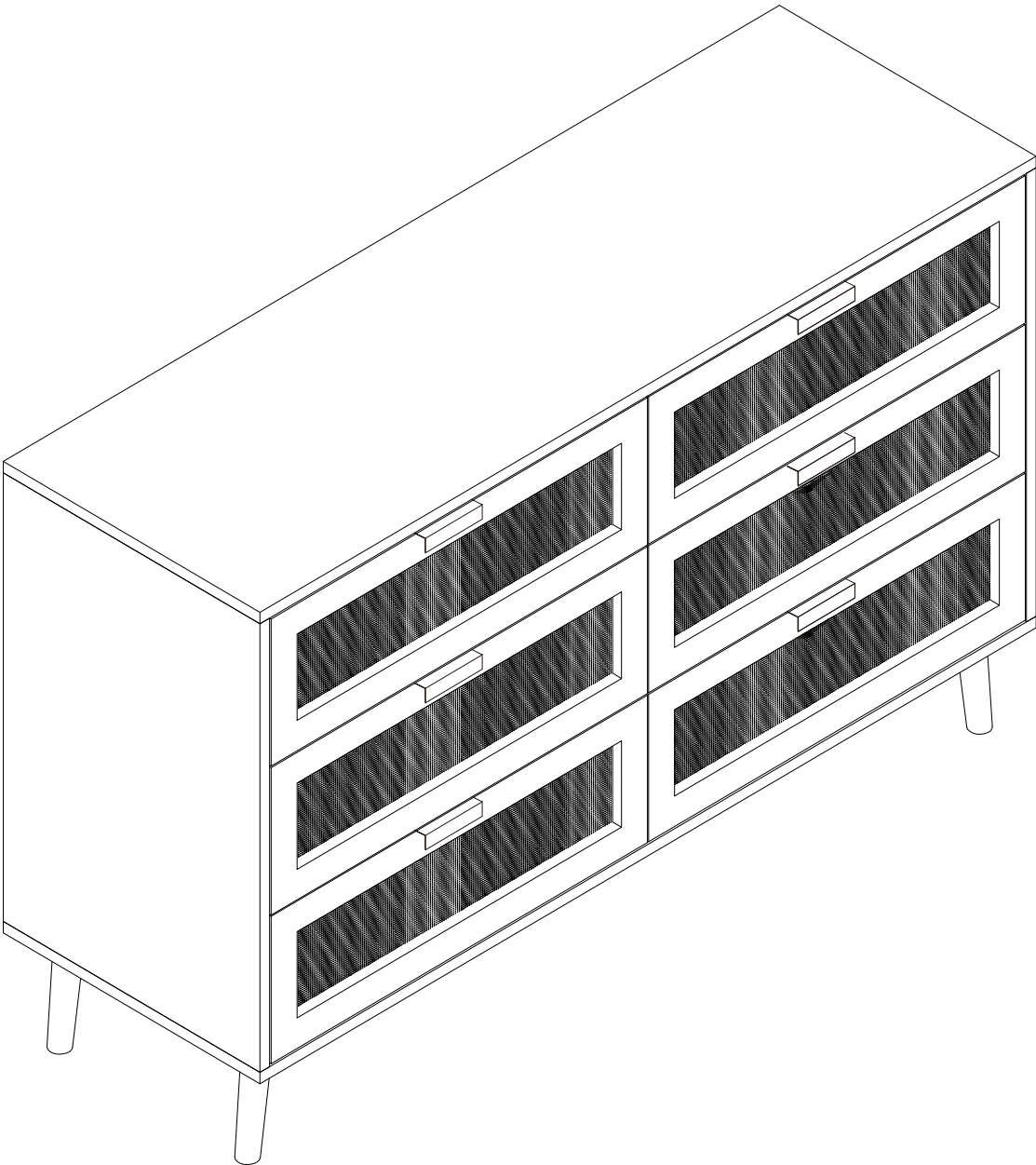

Panels

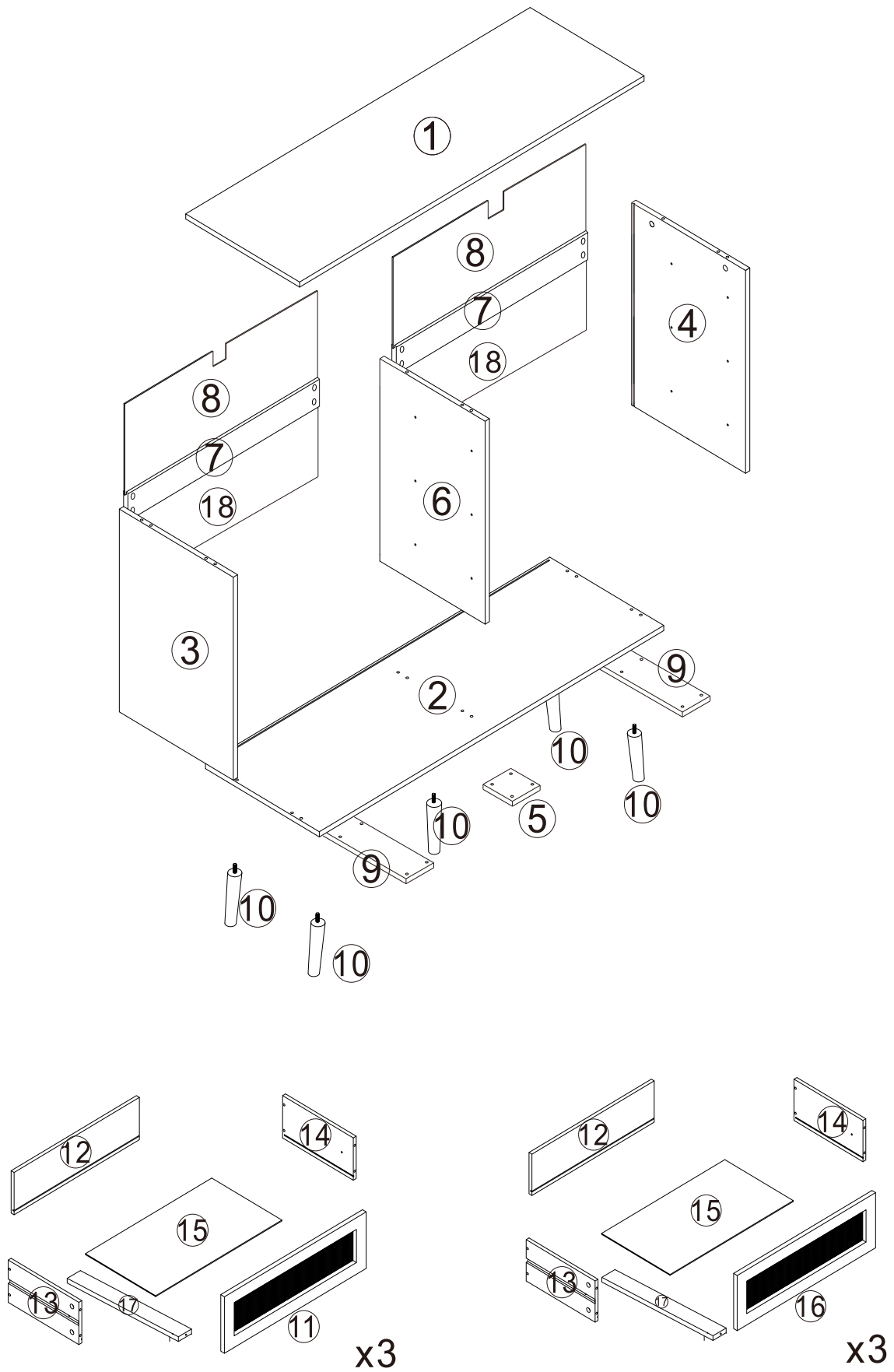









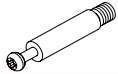





Fittings

Please verify that you have all the listed accessories below:

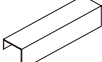
NOTE: The quantities provided are sufficient to complete the assembly, and in some cases, there might be more accessories supplied than required.

Bag 1

ITEM	PART	QTY	ITEM	PART	QTY
A		44 PCS	B		44 PCS
C		12 PCS	D		30 PCS
E		36 PCS	F		2 PCS
G		6 PCS	H		2 PCS
I		2 PCS	J		16 PCS
K		6 PCS	L		2 PCS
M		12 PCS	N		12 PCS

Tools required

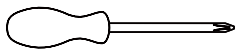

Phillips screwdriver
(small & medium)

step 1

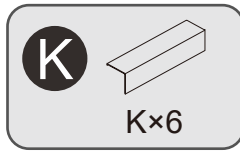
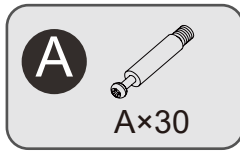
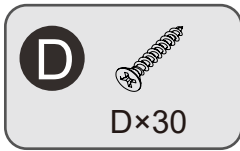

X6

REPEAT
for six
Drawers

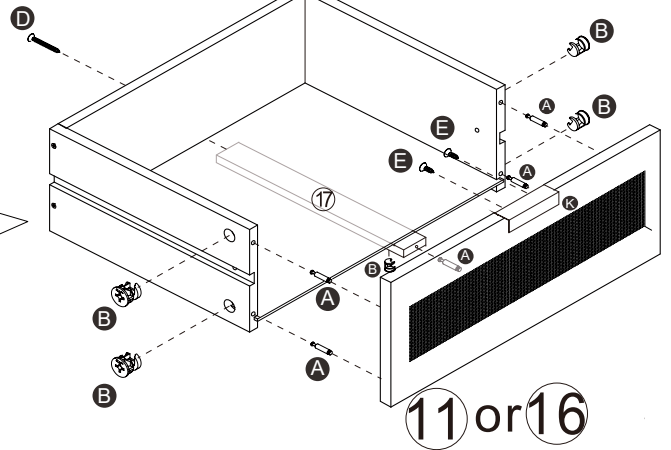
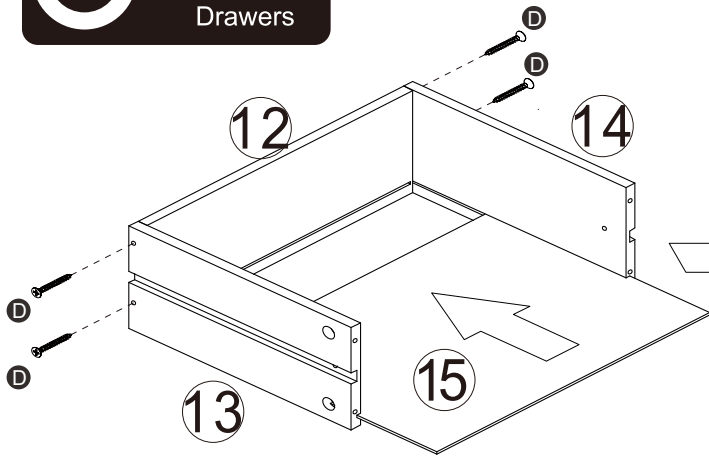

step 2

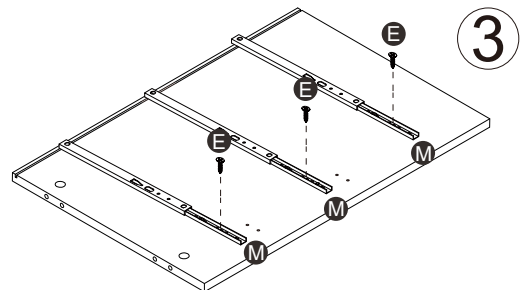
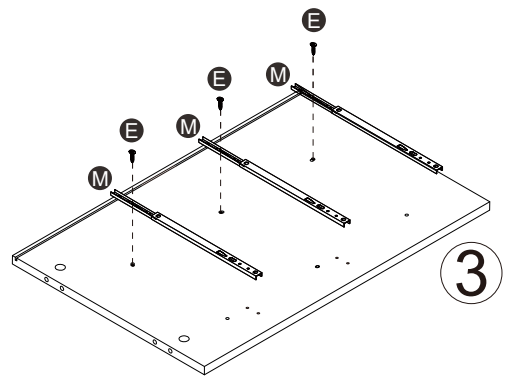
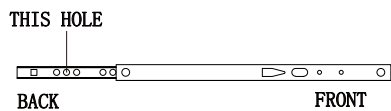
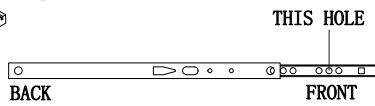
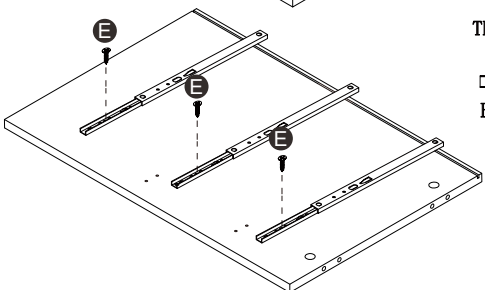
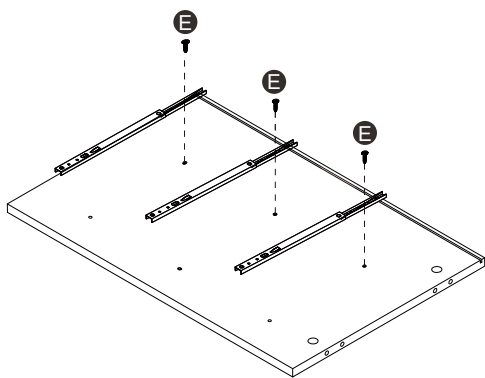
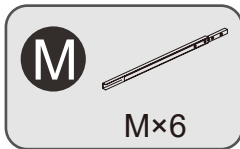
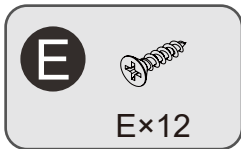

step 3

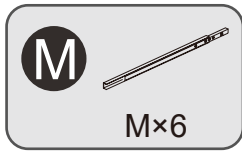
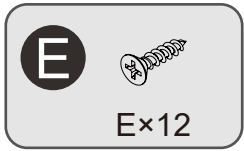

NOTE: Please pay attention to distinguishing the left and right direction of #6 board. The upper part is the right side to install #6 board, and the lower part is the left side.

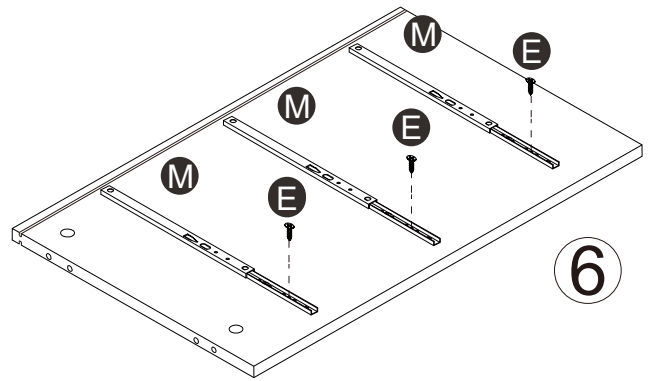
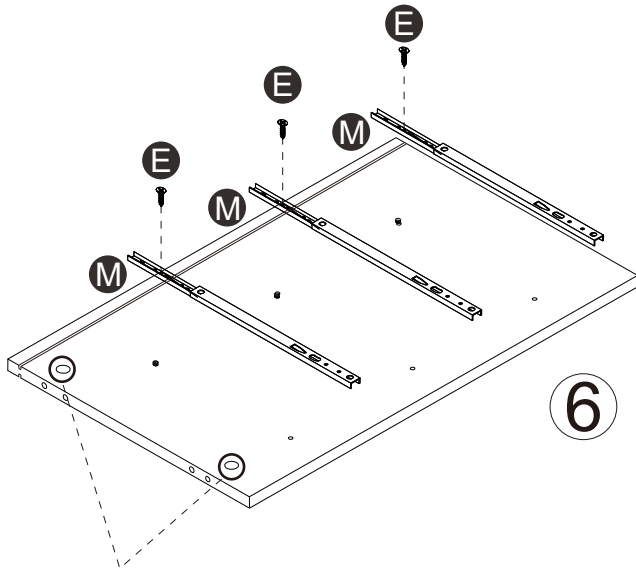
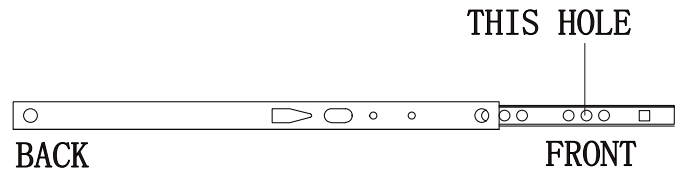
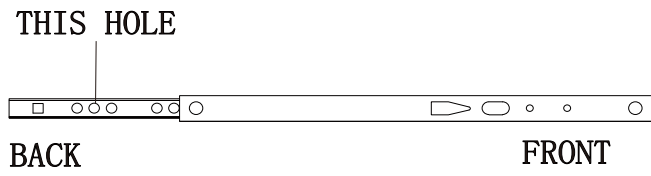

As shown in the picture above, the side of the board with the TWO HOLES is the right side.

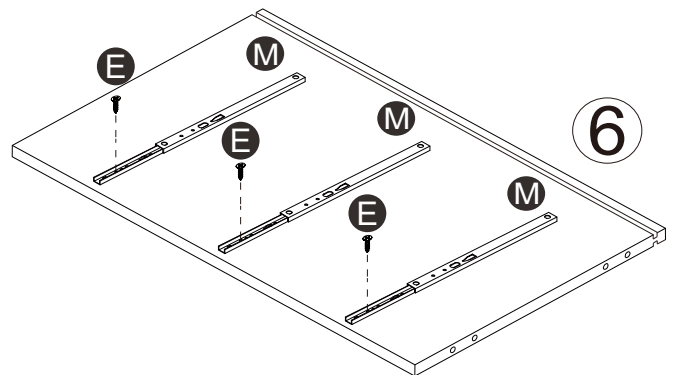
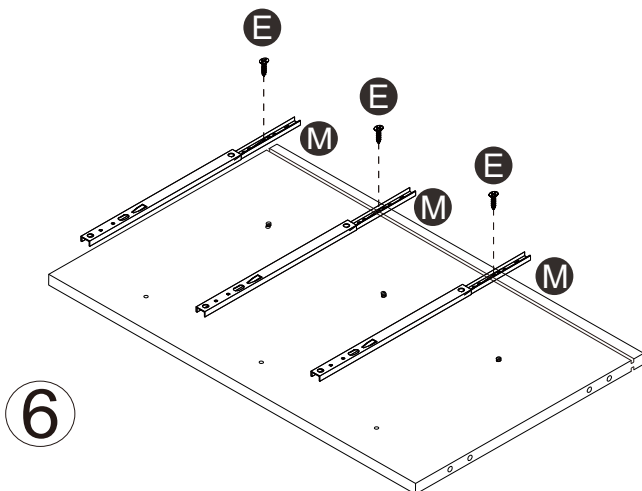
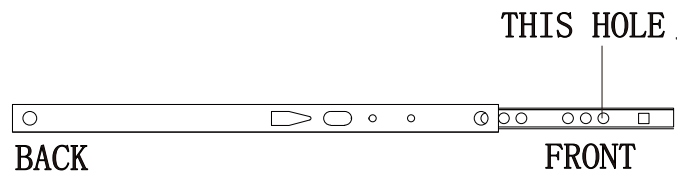
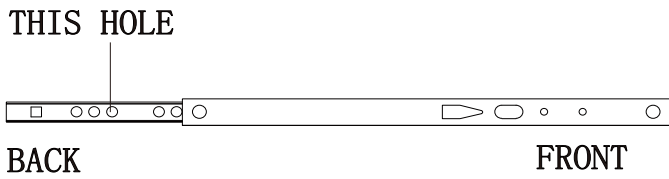

step 4

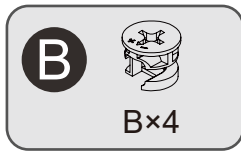
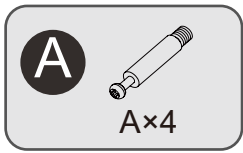

NOTE: In the next steps 4, 5, and 6, please pay attention to distinguish the direction of the board #3 and #4.

The #3 board is installed on the left side of the dresser, and the #4 board is installed on the right side.

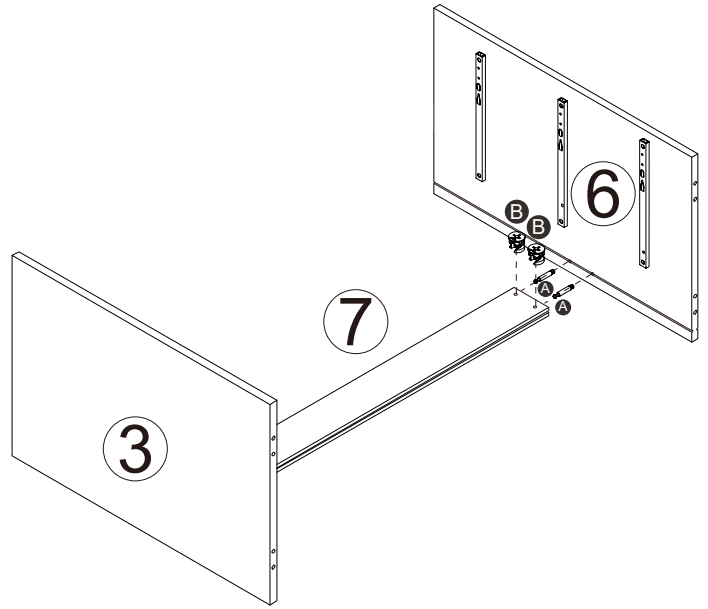
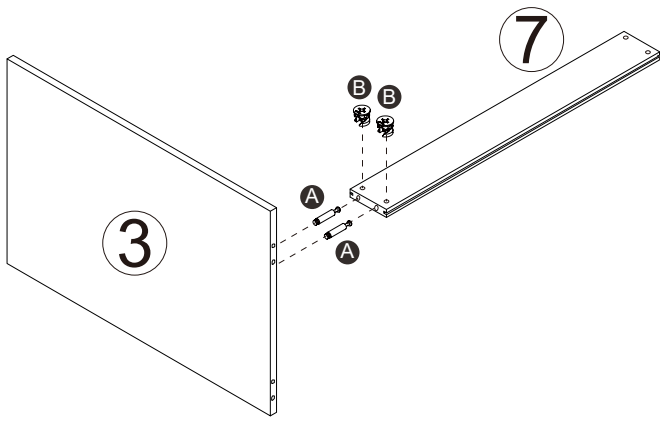

step 5

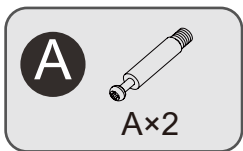

As shown in the picture above, the side of the board with the TWO HOLES is the right side.

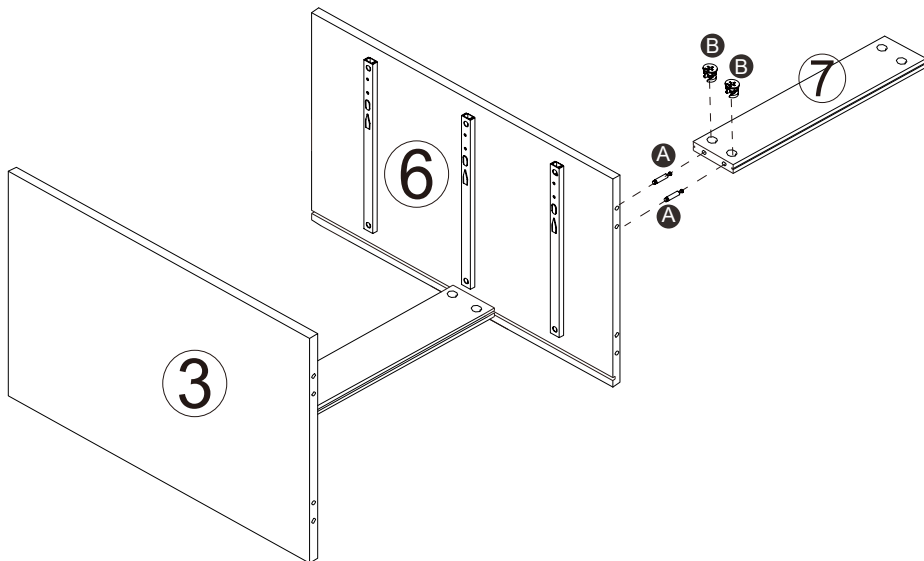

step 6

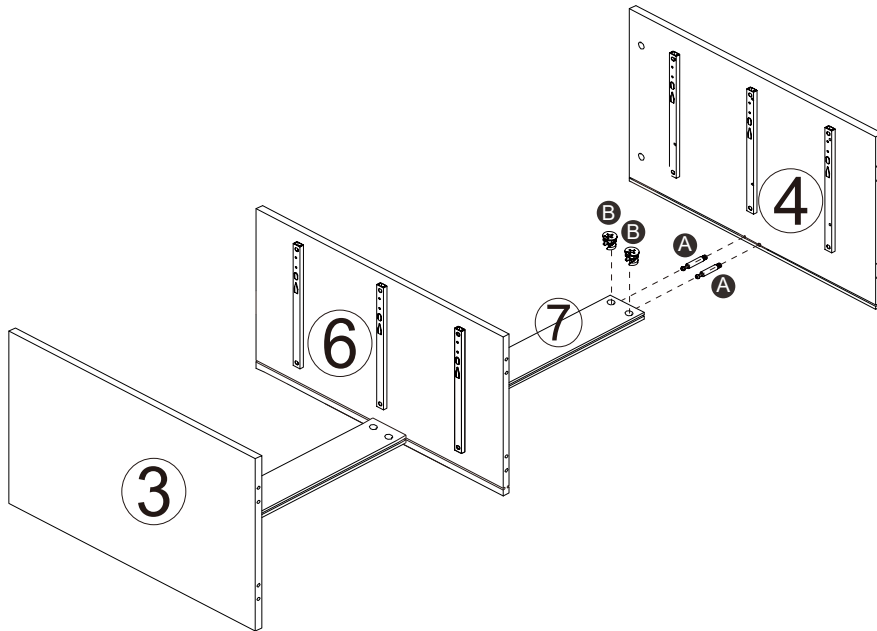
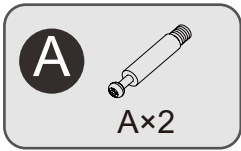

step 7

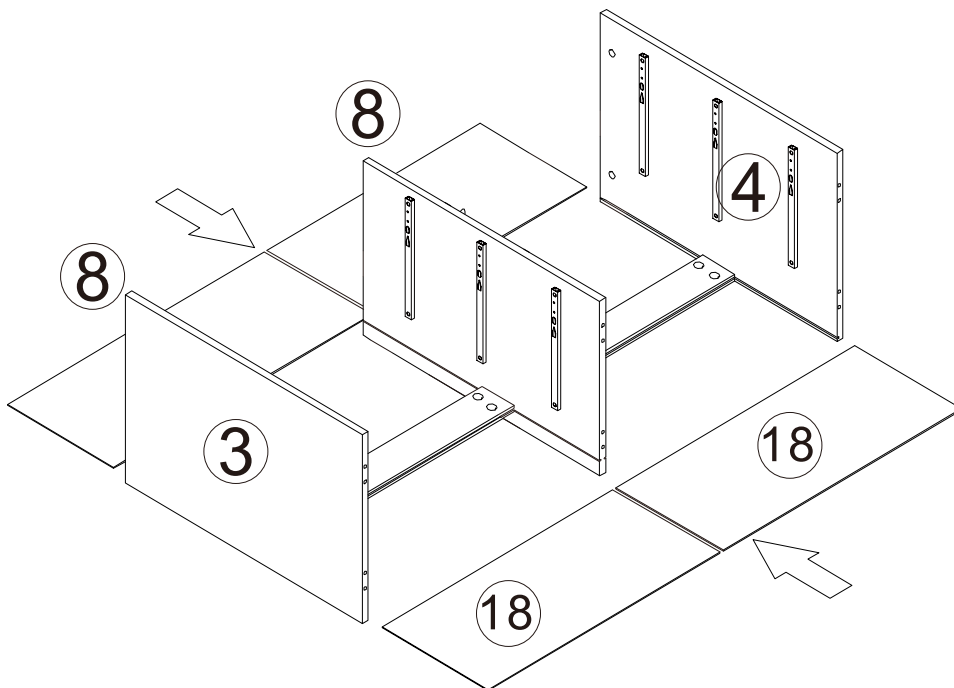

step 8

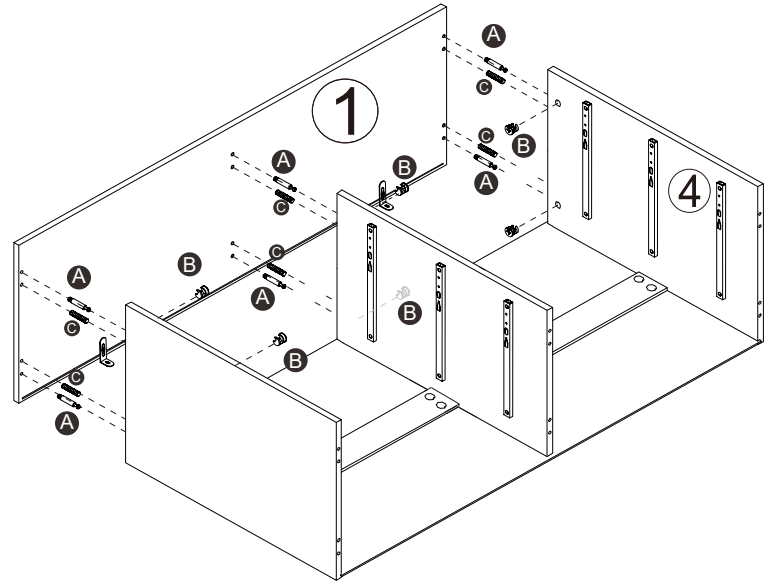
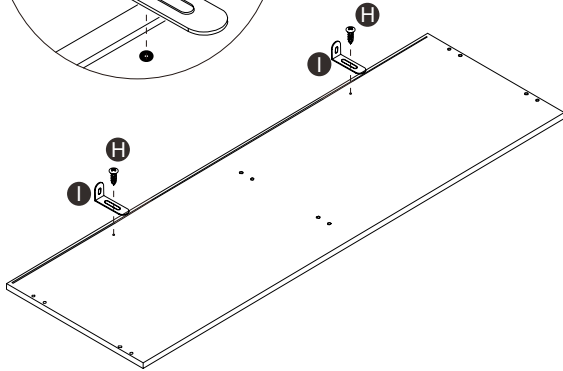
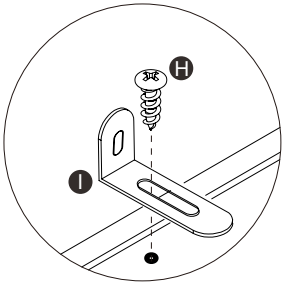
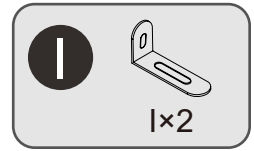
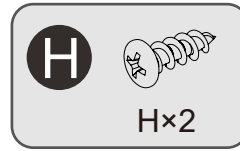
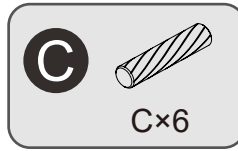
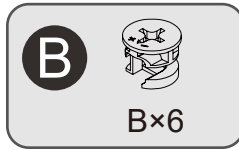
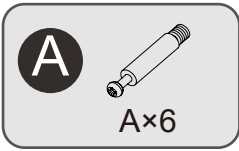

step 9

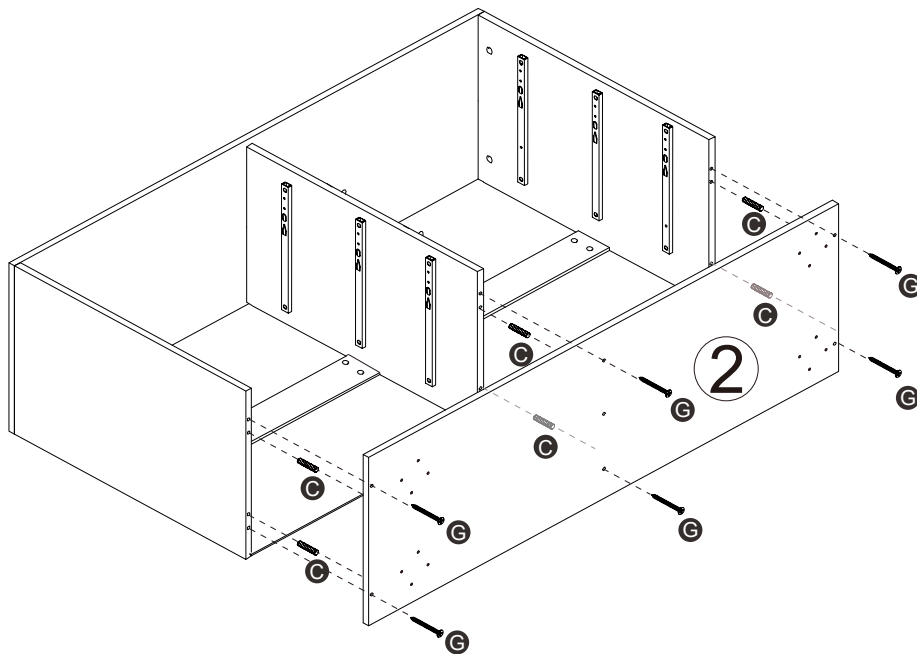
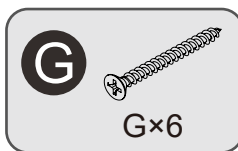
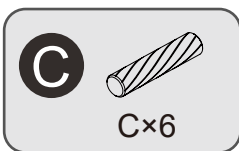

step 10

NOTE: Please pay attention to distinguishing the front and back of the #9 board. The ✓ labeled side is the front side and should be exposed on the outside.

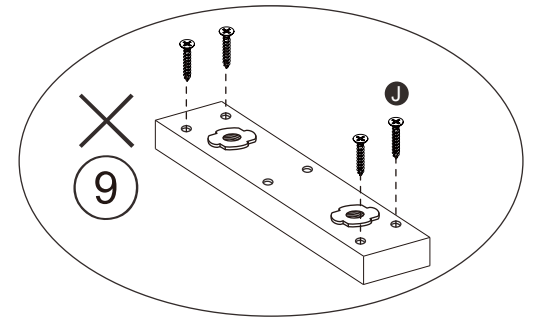
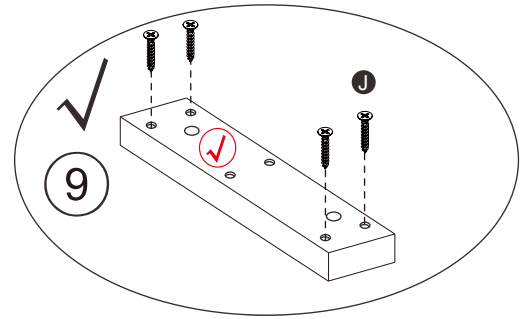
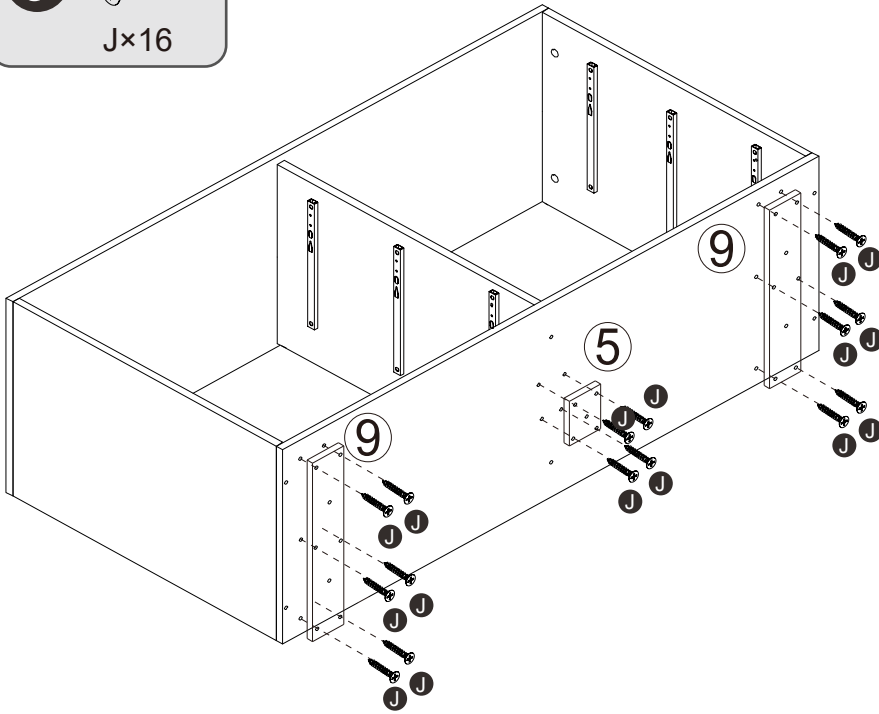

step 11

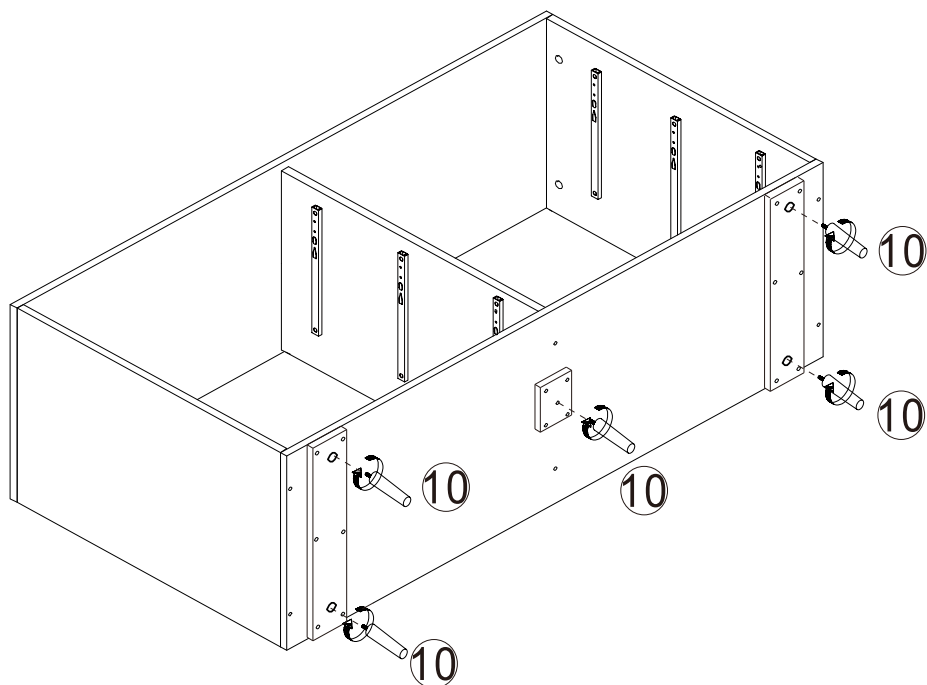

step 12

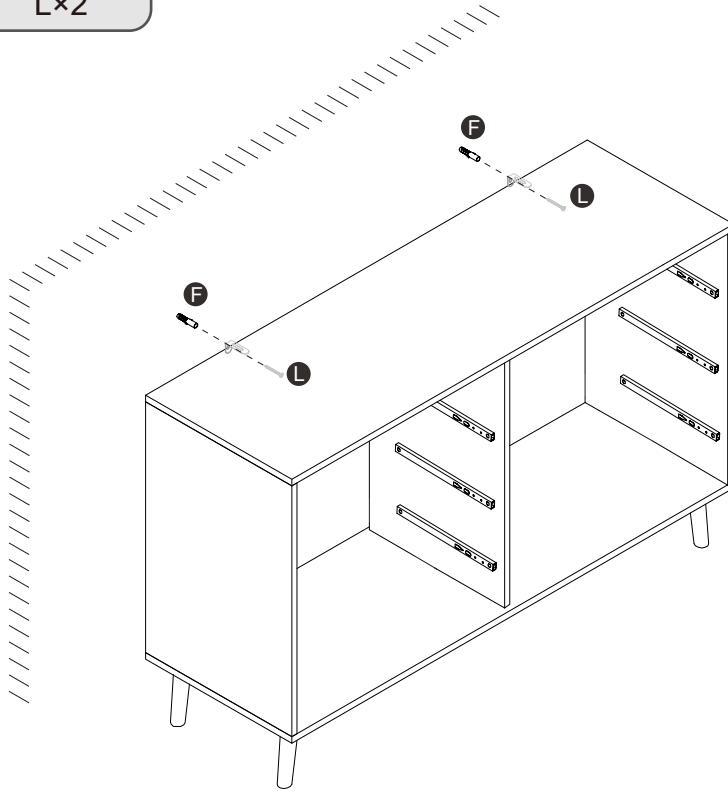
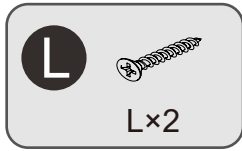
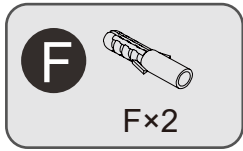

step 13

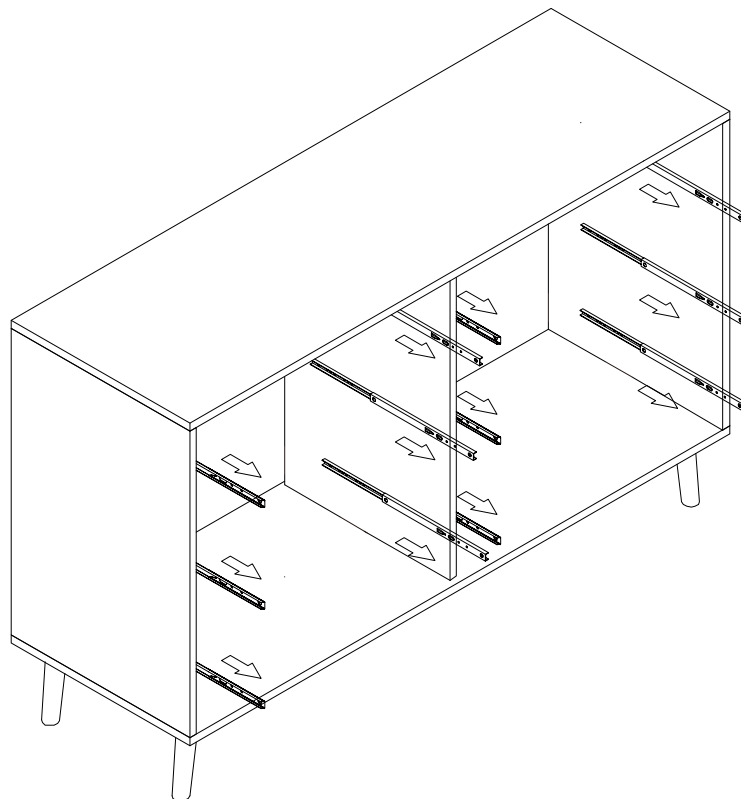

step 14

Note: Please pay attention to distinguishing the left and right directions of the drawer.
The #11 board is on the left side of the drawer, and the #16 board is on the right side.

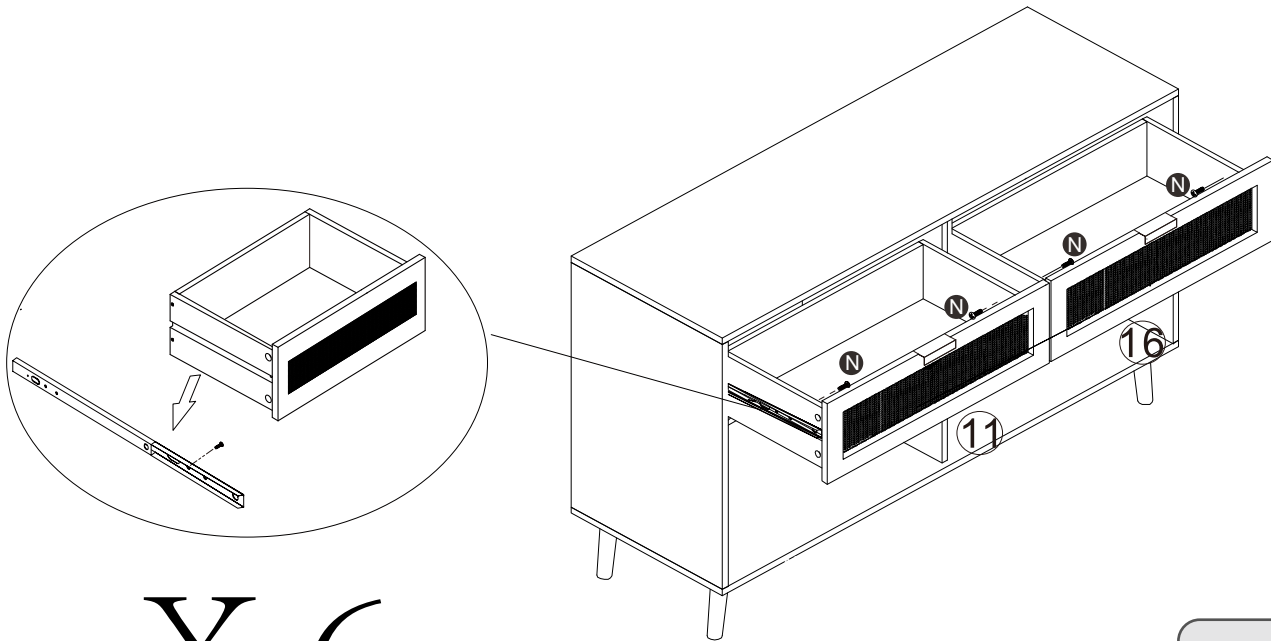

X 6

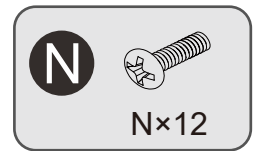

step 15

Congratulations!!

You have successfully completed the assembly!

