



Integrated Intelligent Toilet Operation Instruction

If you have any issues, please contact email: service@theyulika.com

Before installing and using this product, please read the product manual carefully and keep it properly for reference.

01/ Packing list

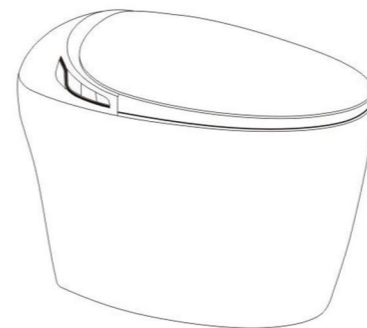

① Intelligent toilet

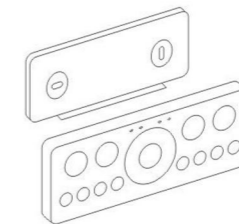

② Remote control assembly
(including 1 bracket and 2 No.7 batteries)



③ O-ring

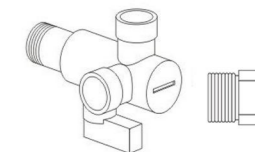

④ Angle valve assembly and converter

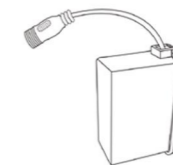

⑤ Spare battery box
(large pump/pulse)

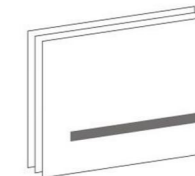

⑥ Instructions and other printed materials

02/ Component Introduction

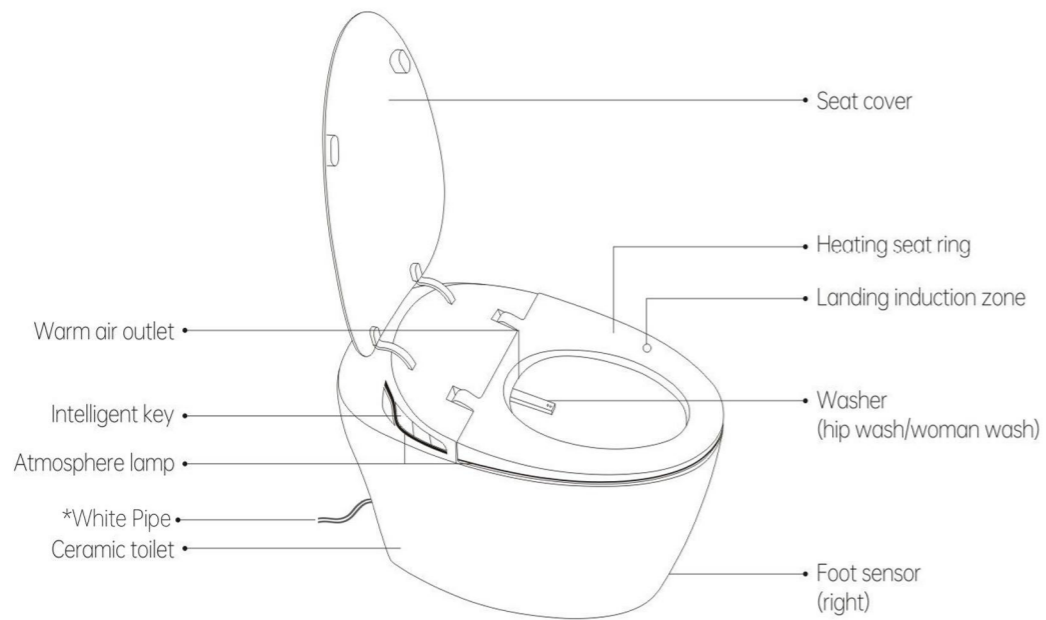

*It comes with the toilet and needs to be used for cleaning function. Please pay attention to the subsequent assembly of this white pipe.

03/ Product installation

Installation environment and specification confirmation

1. Check whether the pit spacing of sewage pipes and the smoothness of toilets meet the installation requirements.
2. Check whether the waterway, water supply pressure and circuit system are in compliance with the installation.
3. While ensuring the space required for installation, please pay attention to whether the surrounding objects (doors, cabinets, etc.) interfere with or affect the installation of the product and the use of functions (such as opening and closing of seat cover and seat ring).
4. If it is necessary to rebuild waterways and circuits, please seek professionals.

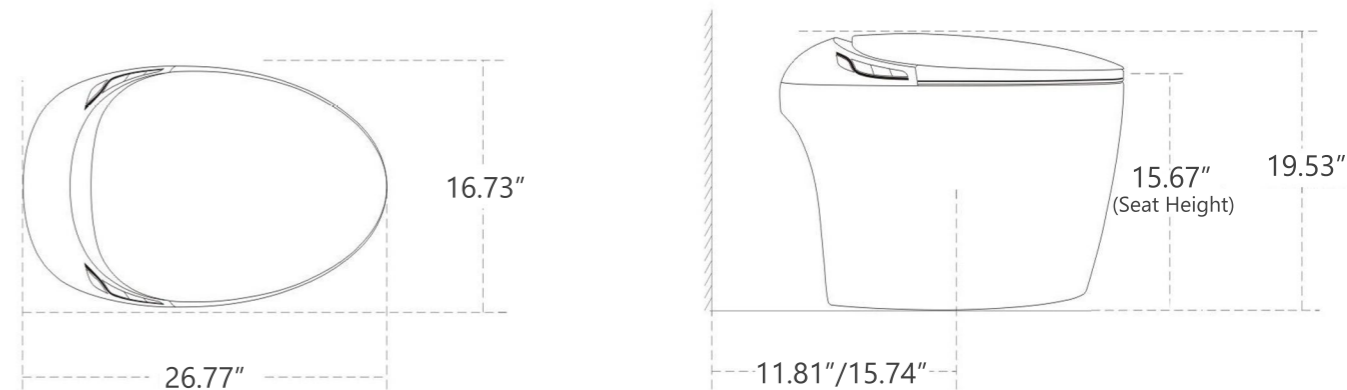

Tip: The dimensions, accessories and user interface of this product are schematic diagrams for reference only. Due to the update and upgrade of the product, the physical product may be slightly different from the schematic diagram, so please give priority to the physical product.

Toilet installation

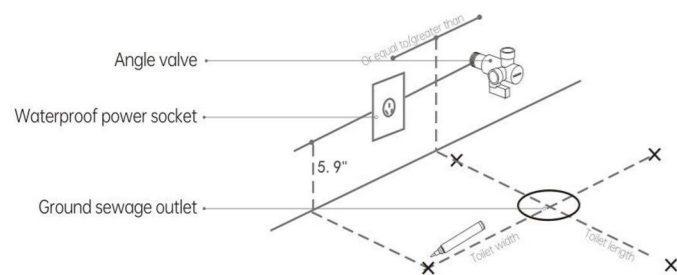

Install the water supply angle valve equipped with the toilet (if there is an old angle valve, please remove it).
Clean the bathroom floor and dry the water.
Measure the size of the bottom of the toilet (there is a slight deviation in the size of large ceramic products, subject to the actual product specifications), and mark the corresponding position on the ground with a marker.
* Please close the main water inlet valve before installation to avoid water leakage.

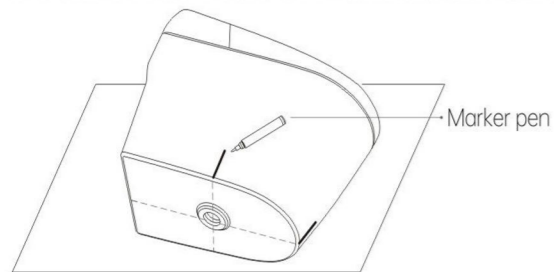

Turn the toilet over against the cardboard/foam.
Mark a line perpendicular to the ground on the side corresponding to the center point of the toilet sewage outlet and the center of the front of the toilet, so as to prepare for the rear installation that can be aligned with the sewage outlet.

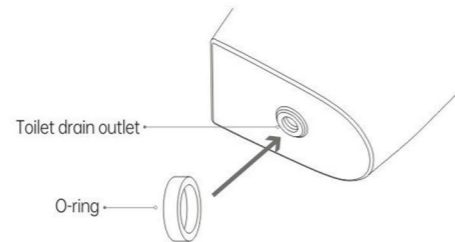

Install the sealing ring tightly at the bottom of the toilet drain.

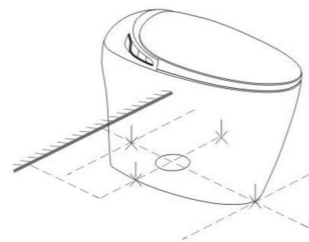

Lift the toilet, align the mark on the toilet with the ground mark as a control, and slowly place the toilet on the ground to make the two marks overlap.
After overlapping, the ceramic body is pressed down, so that the sealing ring fully contacts the ground and is closely connected with the ground.
After placing the toilet, do not move the toilet or shake it from side to side, otherwise the sealing performance of the sealing ring may be damaged, resulting in water leakage.

Open angle valve to supply water.

- After taking out the toilet, connect the 4-point water inlet pipe to the angle valve and tighten it.
- Turn the water supply angle valve to the left to open it, and make sure that there is no water leakage/seepage at the connection part. If there is water leakage, please reinstall the component.

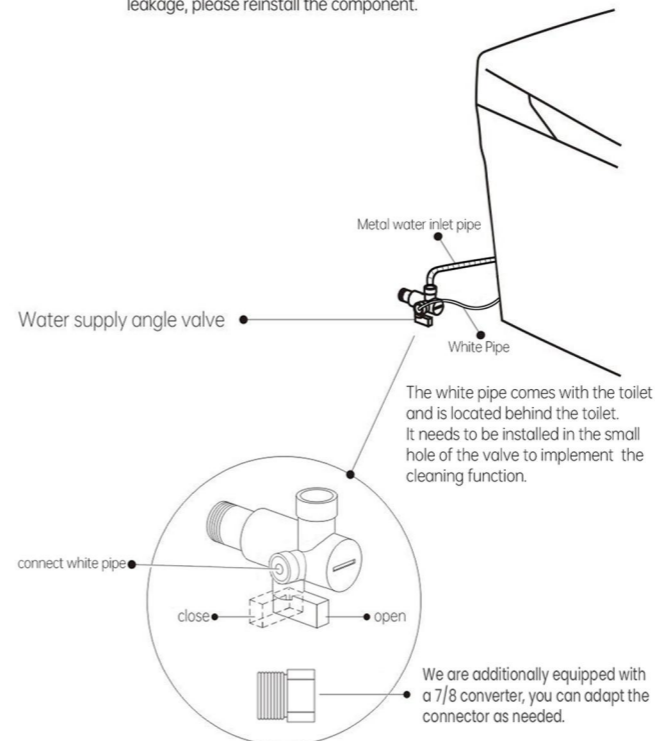

* In order to complete the installation successfully, please use the valves we provide to avoid normal use after the installation is completed.

Start the toilet

- Insert the power plug into the 110V waterproof socket; Make sure that the socket is connected to the power supply and working grounding. Click the reset button to start the toilet, and confirm that the plug indicator light is on.

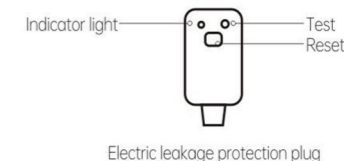

Toilet test machine

- After the toilet is started normally, start various functions to check whether it works normally.
Starting the flushing function is to check whether it is running normally.
Whether the functions such as cleaning/drying are enabled for normal operation after being attached to the sensing area of the toilet seat.
- Click the buttons of the remote controller to confirm whether the remote controller can be started and stopped normally.
There is no response when the remote controller is clicked. Please reconnect. For the connection method, please refer to "Remote Controller Alignment Code (Page 10)".

Fixed toilet

- After confirming that the functions of the toilet are working normally, fill the uneven area of the ground with fillers to stop the toilet from shaking.
- Once again, make sure that there are no foreign objects and water stains on the ground, use a glass glue gun and other fixing devices to apply fixing colloid to the part of the bottom of the toilet that contacts the ground.
- Do not move or use the toilet within 48 hours after fixing.

04/ Safety precautions

· This product is a Class I appliance. For your life safety and property safety, please read carefully and observe the following precautions.

· In order to prevent the danger of arbitrarily resetting the fuse, this product seals the fuse; It is forbidden to use fuses that do not meet the product specifications.

· Description of signs and drawings is as follows:

Warning: It means that improper handling of the product may cause death or serious injury to the user.

Caution: It means that improper handling of the product may lead to injury or material injury to the user.

Prohibition: it means that it is not feasible and prohibited.

Mandatory: it means that it must be observed.



LANDING

· Confirm whether this product is reliably grounded.

· When the power supply is not grounded, it may lead to leakage and electric shock.

· Working grounding, please ask the electric company or electric operators for assistance.



PROHIBIT

· No disassembly: it is forbidden to disassemble, repair or transform this product unless the after-sales maintenance personnel or designated professional maintenance personnel of our company.

Otherwise, it may cause fire, electric shock and other accidents.

· Do not splash water: Do not add water or detergent to the product body or wet the power plug.

Otherwise, it may cause fire, electric shock and other accidents.

· No kindling: Do not put lighted cigarettes or combustibles near or into the product.

May cause fire or electric shock and other accidents.

· Do not touch with wet hands: Do not touch or plug the power plug with wet hands.

Otherwise, it may cause electric shock and other accidents.

· Do not use faulty products, otherwise it may lead to fire or electric shock and indoor water seepage.

Please unplug the power supply and close the water valve to terminate the water supply under the following circumstances:

-When the main body or water pipe leaks

-When the product is cracked or damaged.

-When there is abnormal noise or smell.

-When the product smokes

-When the product is abnormally hot.

When the seat ring or cover plate is damaged, please stop using it to avoid dangerous situations.

Please be sure to unplug the power supply, turn off the water source and contact the dealer or

after-sales service center.

Otherwise, it is easy to get an electric shock and fire.

· It is forbidden to use water sources other than tap water or potable water.

Otherwise, it may cause cystitis, dermatitis and electric shock and fire caused by internal corrosion of machinery.

· Do not bend or flatten the connecting water pipes.

Otherwise, it may lead to water leakage, reduced water pressure or no water.

· It is forbidden to split the water pipe with the water stop valve open.

Otherwise, it may cause water splashing, water spraying or water leakage.

· It is forbidden to use loose, shaking and other bad power sockets.

Otherwise, it may lead to fire or electric shock and other dangerous situations.

· It is forbidden to exceed the specified specifications of power supply or socket, and only 220V AC can be used.

Otherwise, it is easy to cause fire and electric shock.

· It is forbidden to arbitrarily pull, damage, forcibly bend and twist, stretch, curl, bundle, bear load, excessively pinch or destroy the power plug and power cord.

Otherwise, the damage of the power plug and power cord will lead to electric shock or fire.

· If the power cord is damaged, in order to avoid danger, it must be maintained and replaced by the manufacturer, after-sales service personnel or professional maintenance personnel.

Otherwise, it is easy to cause fire and electric shock.

· Do not use it in lightning weather (please unplug the power supply when there is lightning nearby).

Otherwise, accidents or failures may occur.

· Do not pour urine into the outlet of warm air.

Otherwise, there is a danger of electric shock.

· Do not put fingers or other objects in or block the outlet of warm air. Do not cover the warm air outlet when the product is in use.

Otherwise, it may cause burns, electric shock or burning of accessories.

· Do not discard any sundries except excrement and toilet paper in the toilet.

Otherwise, it may cause the toilet to be blocked, sewage to come out or indoor water seepage.

· Do not put heavy objects on the toilet lid, and do not hit this product. Product fragmentation may cause personal injury, and toilet fragmentation may cause problems such as room flooding.



PAY ATTENTION TO

· Do not use the "high" and "medium" settings of seat temperature and warm air/air temperature for a long time.

Otherwise, there will be a danger of burns if you use it for a long time.

· When using the cleaning and drying function, please keep the seat state, that is, the skin is close to the sensing area of the seat ring.

Otherwise, the product will stop cleaning or warm air drying.

· Do not spray urine directly on the product body or nozzle/cleaning tube.

Otherwise, dirt will be generated, leading to blockage.

· Please use the new hose assembly that comes with this machine, and the old assembly cannot be reused.

If there are other appliances connected to the water source randomly, please replace them together.

Otherwise, it is easy to cause water leakage and property loss.

· Do not use it in the bathroom that is too humid and easy to soak in water. Avoid spraying water on this product or washing it with water to prevent water from entering the product and causing losses.

Otherwise, it is easy to cause electric shock and fire.

· When there is a sudden power failure, please unplug the power plug and close the angle valve to prevent water leakage.

Otherwise, it is easy to cause water leakage and property loss.

· Please avoid direct sunlight or heating equipment near this product.

Otherwise, the product may become discolored.

· To avoid the danger caused by the wrong reset of the thermal circuit breaker, please do not supply power through external switching devices, such as timers or circuits that are connected to be switched on and off by common components at regular intervals.

· When it is not used for a long time, please unplug the power supply, turn off the water source and drain the accumulated water inside the product.

Otherwise, the damage caused by frozen internal water will lead to fire and water leakage.

· In cold winter, when the product is transported for a long distance or stored for a long time, the remaining water in the product may freeze. To prevent damage caused by freezing, please take anti-freezing measures.

Otherwise, the damage caused by frozen internal water will lead to fire and water leakage.

· In the same room or area where this product is installed, it is necessary to install a water stop valve at a position within reach, which can be used to cut off the water inlet channel of this product without tools in case of emergency.

Otherwise, the unexpected failure of this product may lead to the loss of users.

· Please don't bury cementing materials (cement mortar, etc.) in the pedestal of the toilet to prevent the toilet from cracking due to expansion.

· Unplug the power plug regularly and wipe the dust on the power plug with a dry cloth.

Otherwise, when the insulation is poor, it will cause a fire.

· When cleaning and maintaining the toilet, do not use unsuitable cleaning agents (such as concentrated sulfuric acid, concentrated nitric acid, glacial acetic acid, carbon chloride, chloroform, acetone, butanone, benzene, toluene, phenol, cresol, dimethyl formamide, methyl ether, soybean oil, acetate, 40% nitric acid, concentrated hydrochloric acid, 95% alcohol, gasoline, kerosene, brake oil, etc.).

Otherwise, the plastic part may crack, or cause personal injury, electric shock or fire.

· Do not lean back, stand on the cover, or roughly open and close the seat cover and seat ring to avoid damage.

Otherwise, it is easy to be damaged and cause personal injury.

· When using the battery, please follow the following operation.

Only batteries that meet the national regulations are allowed to be used. Misuse of batteries may make safety protection ineffective and lead to explosion, fire and other dangers. Do not place the battery in high temperature environment, such as sunshine, fire, oven, etc., which may lead to explosion and leakage of flammable liquid or gas. Do not disassemble, bump, squeeze or cut the battery, which may cause explosion. The battery is swollen and deformed, please stop using it immediately. Please keep the battery away from children. If you swallow it or put it in any part of your body, please seek medical assistance immediately.



FORCE

· People (including children) with physical, perceptual and intellectual disabilities or lack of experience and common sense should be accompanied and guided by adults.

· Children should be supervised to ensure that they will not play with this appliance. Otherwise, personal injury may be caused.

· Please help the following people to turn off or turn down the temperature gear when using the heat preservation seat \ warm air drying function:

Children, the elderly and other people who cannot adjust the appropriate temperature themselves;

People who are not physically free can't make a conscious response;

People who may fall asleep after taking sleeping pills, drunkenness, fatigue, etc.

· When installing/replacing the filter screen and filter, it is necessary to tighten it, and close the water supply channel and angle valve.

Otherwise, it is easy to cause water leakage.

· When the product leaks, please close the waterway valve to stop the water supply.

· It is forbidden to use this product in the environment below 0°C.

Otherwise, freezing may cause water pipes or main bodies to be damaged, resulting in water leakage or failure.

Maintenance and cleaning



PAY ATTENTION TO

This product is an electronic product, please pay attention to prevent water from entering the product.

The seat induction part of the seat ring should be kept clean, so as to prevent the seat ring and other articles from wrapping the seat induction area.

Dirt sensing parts and tight adhesion of foreign objects may cause the product to run incorrectly or not.

Do not use detergent to clean the filter, please use clean water.

· Plastic appearance

The exterior parts of the toilet are mostly made of plastic. To prevent the plastic from being damaged and scratched, please clean and maintain it according to the following methods:

Usually, please wipe it with a cloth that is soft in nature.

If necessary, please wipe it with a cloth dipped in some neutral kitchen cleaner, and then wipe it with water. After cleaning the ceramic part, the detergent remaining on the toilet plastic should be wiped clean with a soft cloth.

Because it is an electrical product, in order to prevent water from entering, it must be dried with a soft cloth after cleaning.

· Clean the filter screen of the angle valve (it is recommended to clean it every 3 months).

① Close the toilet corner valve and stop the water supply.

② Use a coin or a flat-blade screwdriver to clamp into the slot of the front cover of the angle valve, and rotate counterclockwise to remove the water inlet filter.

③ After the filter screen is removed, rinse the attached dirt with water. Generally, small attachments can be removed with a toothbrush, etc. For larger ones, please remove them with a cotton swab, etc.

④ Screw the filter back to the angle valve clockwise, and be sure to tighten it, otherwise it will cause water leakage.

· Clean the toilet washer

① When you are away from the seat, click the "self-cleaning" button on the remote control, and the washer nozzle will stretch out and start draining.

② Clean the surface of the cleaner with a soft brush or toothbrush, and clean the dirt/scale on the nozzle.

(The self-cleaning mode will automatically stop after 80 seconds, so you can click the "Stop" button to turn off the function in advance; Don't push the nozzle)

· Freezing in winter (when the ambient temperature is lower than 4°C)

When you don't use it for a long time, such as business trip or travel, please empty the toilet to store water to avoid freezing and cracking.

① Close the water supply angle valve, press the flush button on the remote control, start flushing and empty the water tank.

② Enable the self-cleaning function to empty the residual water in the toilet.

③ Loosen the water supply pipe on the angle valve and dump the accumulated water in the pipe.

④ Cut off the power supply to the toilet.

(Pulse smart toilets need to turn off the water supply before draining after flushing is started.)

After the product is stored in a low temperature environment for a long time, if it is moved to a high temperature room, the product should be left for 30 minutes until it is naturally thawed, and then the water should be turned on to avoid the internal failure of the appliance. If it is frozen, unable to flush or clean, the cloth soaked in hot water can be covered on the water supply hose of the toilet or the connection part of the water supply hose to thaw it. (Do not pour hot water with high temperature or blow hot air on the product body, water supply hose and other objects).

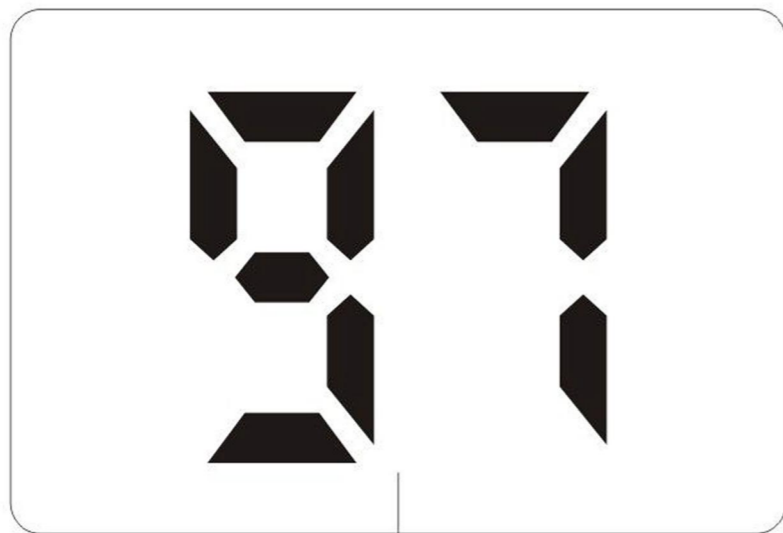

When lit, the water temperature is displayed.

Display screen interface

Remote control front

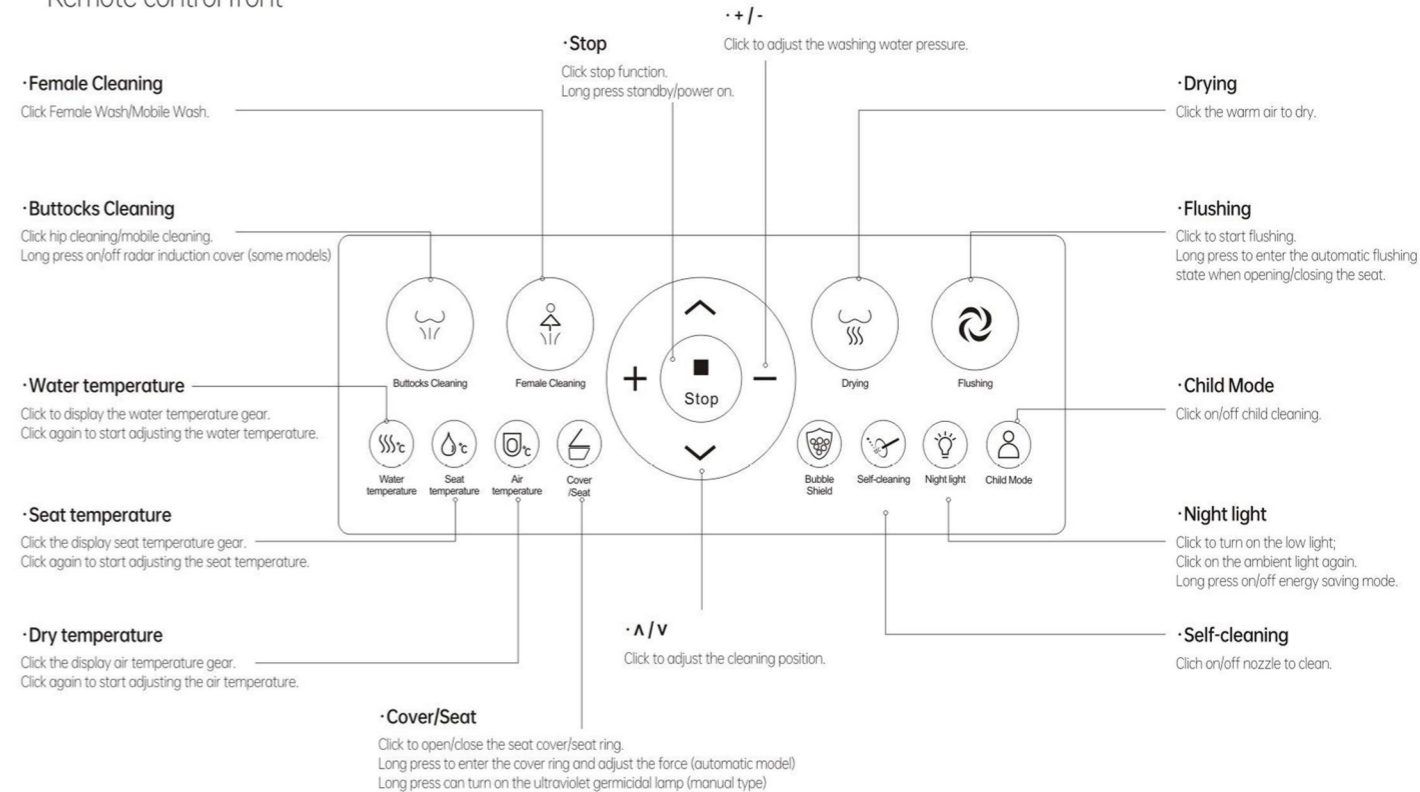

Tip: "Flip, flip, bubble guard" and other functions can only be used in the model with its configuration function.

Remote control code checking: power on again 5 seconds after power off. After power on is normal, press and hold the side washing button for a long time, release it with a sound, and press any button of the remote control to check the code.

Intelligent control key



Stop

Touch is "Stop" command to stop the current work.

Lady/move

Touch to perform cleaning for women. During the cleaning process, touch this button as a "mobile cleaning" switch command.

Hip wash/move

Touch to perform hip cleaning. During the cleaning process, touch this button as a "mobile cleaning" switch command.

Dry

Touch this button, and the drying heating part blows out hot air to dry the buttocks with warm air.

Flush

Touch this key to start the toilet flushing function.

Light

Touch this key to switch the night light and the atmosphere light.

06/ Technical parameters

Rated voltage	110V ~	
Rated frequency	50/60Hz	
Rated power	1050W	
Power cord length	1.5 meters	
Flushing mode	siphon jet water closet	
Cleaning device	Hip washing	The maximum flow rate is 0.75L/min.
	Women's washing	The maximum flow rate is 0.85L/min.
	Water temperature	Normal temperature-about 94°F- about 97°F- about 99°F (4-step adjustment)
	Maximum power of warm water heater	1200W
	Security device	Temperature fuse, thermostat, temperature sensor
Heat preservation seat ring	Surface temperature	Normal temperature-about 94°F- about 97°F- about 99°F (4-step adjustment)
	Seat ring heater	45W
	Security device	Temperature fuse, thermostat, temperature sensor
Dry	Air temperature	Normal temperature-about 95°F- about 113°F- about 131°F (4-step adjustment)
	Warm air heater	270W
	Security device	Temperature fuse, bimetallic thermostat
Water supply pressure	0.15Mpa (dynamic pressure) ~0.75Mpa (static pressure) (1.5 ~ 7.5 kg/cm) (models with water tanks are not limited to this).	
Waterproof grade	IPX4	
Tap water inlet temperature limit	41-95°F An inlet water temperature lower than 41°F will cause the outlet water temperature to be lower than 94°F after heating by the water heater. An inlet water temperature exceeding 95°F will cause the heater to not work.	
Ambient temperature limit	32-99°F If the ambient temperature is lower than 32°F, the seat ring heating will not be heated to 94°F, and the water in the water pipe will freeze, making the cleaning function unusable. If the ambient temperature exceeds 99°F, the seat ring heating will not work.	
Product size	26.77"*16.73"*19.53"	
Product weight	94. 79lbs	
Executive standard	GB 4706.53-2008	

07/ Function Introduction

Classify	Function	Functional description
Basic function	Hip cleaning	The function of cleaning buttocks, when this function is enabled, the toilet will automatically perform procedures such as cleaning and drying buttocks.
	Women's cleaning	Women's cleaning function, when this function is enabled, the toilet will automatically perform women's cleaning, drying and other work procedures.
	Warm air drying	Use warm air to accelerate the evaporation of water droplets, so that the buttocks are dry and comfortable.
Comfort function	Hydraulic pressure regulation	Adjust the water pressure of water spray during cleaning to adapt to users with different sensitivities.
	Position adjustment	Adjust the front and rear positions of the nozzle during cleaning to adapt to users with different sitting postures.
	temperature regulation	The water temperature for cleaning, the seat temperature of the seat ring and the air temperature for drying can be adjusted.
	Mobile cleaning	When cleaning, the water column moves back and forth for a wide range of cleaning.
	Ring cover mute	The damping device is used to make the closing ring and cover stable and low noise.
Humanized function	Night light	Soft lighting night light, guarding the toilet at night.
	Automatic flushing	Automatic flushing after people leave their seats.
	Feet flush	After the man urinates, he flushes the water by triggering the foot sensing device.
Safety function	Overheating prevention	Through software intelligent regulation, temperature sensor, temperature fuse and other multiple protection, to prevent high temperature burns and other situations.
	Electric shock prevention	Set up leakage protection devices to prevent electric shock accidents.
Cleaning function	Nozzle self-cleaning	Before and after each cleaning, the nozzle is automatically cleaned.
		The nozzle will extend out, which is convenient for the user to clean the nozzle manually.
Green function	The water temperature is hot.	When cleaning, the toilet bowl instantly heats the cleaning water supply, saving energy and keeping the temperature constant.
	Energy saving mode	Low power consumption mode, intelligent power saving.
High-equipped function (some models)	Automatic flip cover	Set the human body sensor, and when it is close to the sensing range, it will automatically perform the flip action.
	Automatic loop turning	When the foot sensation is triggered, the loop is turned, and the man does not need to manually lift the seat ring when urinating.
	Spray rod sterilization	After closing the cover and the ring, the spray bar automatically extends out to open the sterilization function.
	Aromatherapy	It can effectively remove odors, purify the air, and give you a pleasant toileting experience.
Built-in water tank (some models)	No water pressure limit	Built-in water tank, with brushless booster pump, no water pressure limit, suitable for low water pressure application environment.

Function	Description and adjustment method
Sit down	In the case of sitting, the functions of hip washing, woman washing and drying can be used normally.
Constant temperature seat ring	Click the "Seat Temperature" button to adjust the seat temperature cyclically, and adjust the gear from low to high cyclically. Please choose the appropriate seat temperature to prevent cryogenic burns.
	When the seat temperature gear is the first gear, the seat ring is not heated. When the seat temperature is the second gear or above, the higher the gear, the higher the seat temperature.
Wash	Click the side button or the "Hip Wash" or "Woman Wash" button of the remote control for cleaning. Each cleaning time is about 120 seconds.
	During the cleaning process, press the current cleaning mode again to turn on or off the mobile cleaning;
	Click the "+" or "-" button to adjust the cleaning water pressure; Click "Nozzle Forward" or "Nozzle Backward" to adjust the cleaning position.
	Click the "Water Temperature" button to adjust the water temperature cyclically, from low to high. Please choose the appropriate water temperature to prevent cryogenic burns.
	When the water temperature is in the first gear, the cleaning will not be heated. When the water temperature is the second gear and above, the higher the gear, the higher the water temperature.
Dry	Start the warm air drying by pressing the side button or pressing the remote control "Drying" button. Each drying time is about 180 seconds.
	Click the "Wind Temperature" button to adjust the wind temperature cyclically, and adjust the gear from low to high cyclically. Please choose the appropriate air temperature to prevent cryogenic burns.
	When the air temperature gear is the first gear, the air temperature is not heated. When the air temperature is the second gear and above, the higher the gear, the higher the air temperature.
Stop	In the process of cleaning or drying, press the side key or the "Stop" key of the remote controller to exit the current cleaning or drying.
Foot induction	Foot induction start mode: close to the infrared sensor triggers the toilet to work.
	In the basic model, the device is started for flushing in the state of leaving the seat.
	In the high configuration style, start the device for flip, flush and close the lid.
	When the seat ring is closed, the foot induction is triggered to flip the cover and turn the ring.
	When the seat ring is open, trigger foot induction, close the ring and cover, and start a flush.
Automatic flushing	After sitting for more than 5 seconds, about 10 seconds after leaving the seat, the toilet will automatically start flushing once.
	Press and hold the "Flush" button of the remote controller for 5 seconds to turn on/off the intelligent flushing system. After turning off, the toilet will stop all automatic flushing functions.

Function	Description and adjustment method
Flushing method	Flushing methods: automatic flushing, manual flushing, remote flushing, and foot flushing.
	Manual flushing: press the side button or the toilet flushing button to flush once.
	Remote Flushing: Press the "Flush" key of the remote controller to flush once.
	Automatic flushing: refer to the above "automatic flushing".
	Foot-felt flushing: refer to the chapter on foot-felt flushing.
	Power-off flushing function: in the power-off state of the toilet, press the side button or long press the side toilet flushing button to flush once.
	Note: If the power failure and flushing are abnormal, please check the battery charge or replace the spare battery in time.
Automatic flip cover	When the seat cover is closed and the human body enters the sensing range of the toilet, the seat cover will automatically turn up.
	After leaving the seat, if the human body leaves the sensing range of the toilet for about 60 seconds, the seat cover will automatically close.
	Long press the remote control "flip/turn" function to enter the flip/turn dynamics adjustment mode.
	Note: This function is only available for high-profile models.
Energy saving function	In the energy-saving state, the toilet enters the low power consumption mode.
	Start the energy-saving mode, set the seat temperature to the second gear and above, automatically maintain the seat ring at 77°F, and resume heating after sitting.
	Press and hold the remote control "night light" button to turn on or off the energy-saving function.
Lighting function	The body is equipped with a low-light lamp, which is convenient for going to the toilet at night.
	Click the remote control "Night Light" button to switch the night light and the atmosphere light on and off.
Bide one's time	Press the "Stop" button of the remote controller for 3 seconds, and the toilet will enter the standby state, and all functions will stop working.
	Press the "Stop" button of the remote controller for 3 seconds again, and the toilet will return to normal working condition.

08/ Diagnosis of functional abnormality

When the product is abnormal, please try the following treatment methods to eliminate and solve the problem. If the problem still cannot be solved, please contact the sales unit or after-sales service center.

Product function	Phenomenon	Inspection items	Exclusion method
Organism	Not working at all	Whether to turn on the power?	Turn on the power
		Is the power plug plugged in properly?	Plug in the power supply again.
		Is there a power outage?	Check again after power supply is restored.
Hip clean Women's clean	The nozzle didn't produce water.	Is the landing induction zone induced?	Adjust the seating position to ensure that the seat sensor detects the human body.
		Is the water supply angle valve open?	Check the water supply of angle valve.
		Whether to stop water?	Re-use until water supply is restored.
		Whether the nozzle is blocked by foreign objects.	Clean up the foreign bodies in the nozzle and dredge the nozzle.
	Low washing water pressure	Is the water pressure gear in the weak gear?	Reset the water pressure
		Is the inlet waterway clear?	Clean the angle valve filter
	Halfway water stop	Does the sensor sense?	Adjust the seating position to ensure that the seat sensor detects the human body.
		Does the cleaning function automatically stop?	Restart the cleaning function.
		Whether to stop water?	Check again when the water supply is restored.
	Low water temperature	Is the water temperature gear at the lowest gear?	Press the remote control "Water Temp" button to adjust the water temperature.
Dry	Low wind temperature	Is the air temperature gear in the lowest gear?	Press the remote control "air temp" button to adjust the air temperature.
	Halfway stop	Does the sensor sense?	Adjust the seat, and confirm that the sensor senses that the human body is seated.
		Does the drying function automatically stop?	Restart the drying function
Seat ring heating	Low temperature of seat ring	Does the sensor sense?	Adjust the seat, and confirm that the sensor senses that the human body is seated.
		Is the seat temperature gear in the lowest gear?	Press the remote control "Seat temp" button to adjust the seat temperature.
Automatic flush	Can't be washed clean	Did flush pipe bend to?	Adjust the position of water pipe
		Is there any foreign body blocking the sewage pipe?	Clear the toilet/sewer.
	Leave the seat without flushing.	Do you want to turn off automatic flushing?	Turn on the automatic flushing function
Remote control	Remote control is not responding.	Battery power is too low.	Replace the battery
		Whether water enters/soaks.	Dry/dry before trying again.

Warning: Except professional maintenance personnel, please do not disassemble, repair or modify the product without permission.

Maintenance regulations

- During the warranty period, after the after-sales service personnel check the failure factors, they can enjoy the maintenance service free of charge.
- If the product needs to be maintained due to failure during the warranty period, please contact the sales unit or after-sales service center, and please show the warranty card when maintaining.
- During the warranty period, maintenance fees (materials and labor costs) shall be charged as appropriate in the following cases:
 - Failure or damage caused by failure to follow the instructions and precautions;
 - Failure or damage caused by fire, earthquake, flood, lightning and other force majeure;
 - Failure or damage caused by transportation, unloading, squeezing, etc.;
 - Failure or damage due to the use of non-designated power sources (voltage, frequency);
 - Failure or damage due to the use beyond the normal use scope;
 - Failure to provide purchase records or to show this warranty card;
 - When this warranty card is not filled in or the contents are modified without authorization.
- This warranty card is no longer issued, please keep it properly.

GUARANTEE CARD

Dear users:
Thank you for purchasing our bathroom products. In order to ensure that we can provide you with quality service, please fill in this card carefully and take good care of it.

User name	Contact number
Detailed address	
Product model	
Bar code	
Date of purchase	
Marketing unit	
Maintenance date	Maintenance unit
Maintenance project	
Maintenance date	Maintenance unit
Maintenance project	
Maintenance date	Maintenance unit
Maintenance project	
Maintenance date	Maintenance unit
Maintenance project	