

Assembly Instructions



Caution: You must read this before you proceed

Barstool

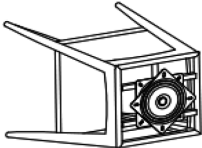

Note: Occasionally some of the PE Wicker shifts and covers the mounting positions preventing easy assembly. The PE wicker should never be cut, but moved away from the mounting positions.

Parts List

Label	Picture	Description	QTY
A		Seat	1
B		Chair Leg Frame	1
C		Seat Cushion	1

Hardware

Label	Picture	Description	QTY
①		Allen Wrench	1
②		Bolt: M6* 20mm	5
③		Washer	5
④		Spring Washer	5

Assembly Preparation

Before Beginning Assembly:

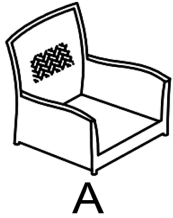

A

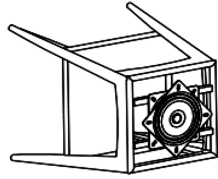

B

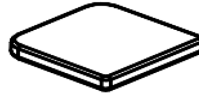

C



①



②

x5



x5

③



x5

④



- Read instructions, cover to cover-



- Have 2 adults on hand for assembly-



- Do not assemble on flooring or carpet-



- Assemble on a clean non-marring surface (packing foam)-



- Save all packaging until finished-

Assembly Steps

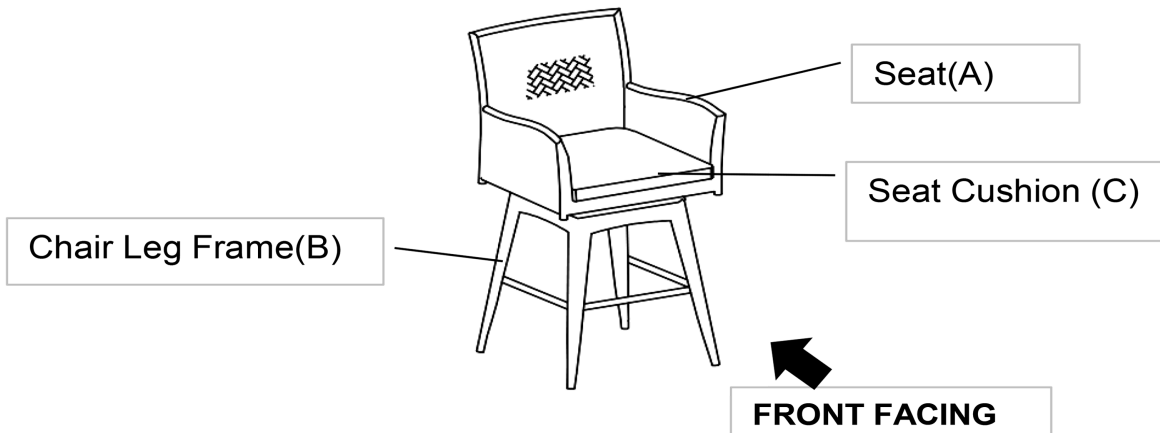

This Barstool has multiple parts and may require up to 30 minutes to assemble. To give you an overview of the Barstool parts, the above picture is to help you put the various parts into perspective. Please read through the instructions below to familiarise yourself with the parts and steps before assembly.

Step 1

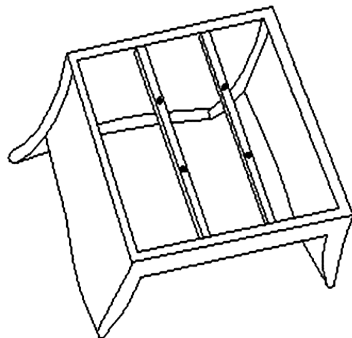

Step1.1

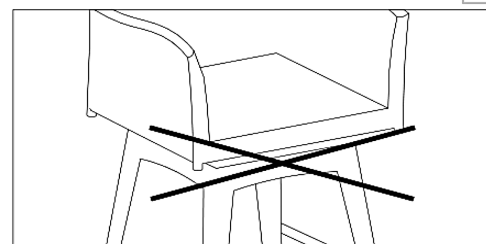

step1.2

Open the carton and place all the parts onto a clean, non-marring surface.

Step1.1 Tilt the Seat(A)with the arm and backrest floor facing, as shown in above picture.
step1.2 Caution: During the assembly process, DO NOT place finger into gap of the Chair Seat and the Chair Leg Frame.

Step 2

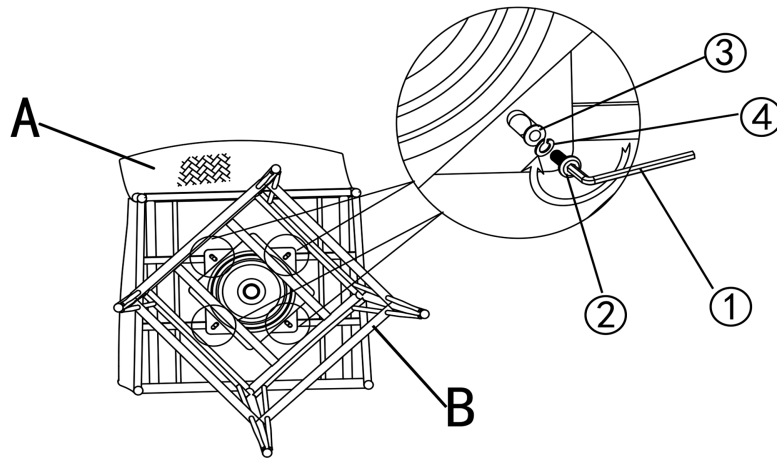

Turn down the Seat (A) & Chair Leg Frame (B) as the picture shown above.

Attach Chair Leg Frame (B) & Seat (A) using Bolts (2) and Washers (3) Spring Washers (4) with Allen Wrench (1) as the picture show.

Dot not fully tighten the Bolts.

Step 3

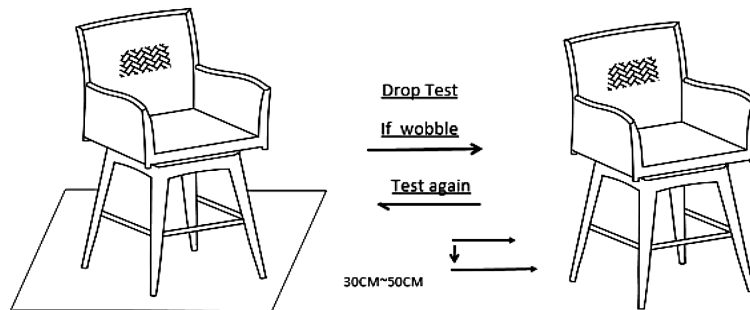

Place the Barstool on a LEVEL SURFACE to check for wobbles. If it wobbles, lift the Barstool some 30cm to 50cm high from the ground. Keep your feet and toes well away from the drop zone. Drop the Loveseat freely and vertically with all four legs, hitting the ground, at the same time. This Drop Test will help to ensure that all the Bolts and gaps reach full alignment status. Test again for evenness on a LEVEL SURFACE. If no wobbles are found, slowly and steadily, place the Barstool facedown. Then, proceed to tighten all Bolts in a sequential manner. When tightening the Bolts, tighten sequentially. DO NOT tighten any Bolt fully and then move on towards the next one. This could cause the frame to warp. If there are still wobbles, loosen the Bolts and execute the same drop test. If the Barstool is not stable, it could lead to damage to the product.

Step 4

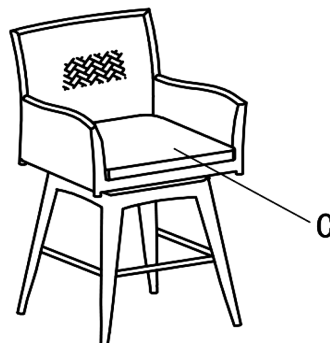











Place the Seat cushion (C) on the Barstool.

The Barstool is ready for use.

The Bastool can only be used on a flat, level surface.

Care & Maintenance

- ⊘  ● Prolonged exposure to rain may cause rusting which can stain floors.
 - ⊘  ● Do not put hot items directly on furniture surface.
 - ⊘  ● Do not clean furniture with harsh cleansers or polish.
 - ✓  ● To obtain the longest lifespan of your outdoor products, minimizing exposure to direct sunlight is recommended.
 - ⊘  ● Children should not climb or jump on the furniture.
 - ⊘  ● Do not write on furniture without a padded barrier to protect the surface.
 - ✓  ● To obtain the longest lifespan of your outdoor products, avoid extended and lengthy exposure to rain, snow, and direct sunshine. Whenever possible cover the product and /or place under patio or awnings.
 - ⊘  ● Not for commercial use. For residential use only.
 - ⊘  ● Stains may be removed with mild soap solution and damp cloth.
 - ✓  ● Keep away from sources of ignition.
-
- ✓  ● Dust and pick-up spills using a clean, non-colored, lint-free cloth.