









Assembly Instructions

Caution : You must read this before you proceed

Care & Maintenance

- ⊘  ● Not for commercial use. For residential use only.
- ⊘  ● Do not put hot items directly on furniture surface.
- ⊘  ● Do not clean furniture with harsh cleansers or polish.
- ✓  ● To obtain the longest lifespan of your outdoor products, minimizing exposure to direct sunlight is recommended.
- ⊘  ● Children should not climb or jump on the furniture.
- ⊘  ● Do not write on furniture without a padded barrier to protect the surface.
- ✓  ● To obtain the longest lifespan of your outdoor products, avoid extended and lengthy exposure to rain, snow, and direct sunshine. Whenever possible cover the product and /or place under patio or awnings.
- ⊘  ● Stains may be removed with mild soap solution and damp cloth.
- ✓  ● Dust and pick-up spills using a clean, non-colored, lint-free cloth.

HANGING CHAIR BASE







CAUTION : Do Not Swing on or in chair. This could cause the product to tip over resulting in possible injury.



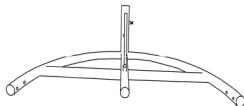
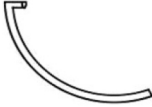
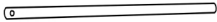









This Support Stand is NOT a TOY.

Keep your child / children at bay during the assembly process.

Part List

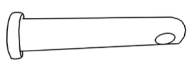
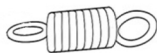
No.	Picture	Description	Qty
A		Base Loosely	1
B		Base Booms - Curved	2
C		Base Straight Boom Loosely	1
D		Bent Metal Holder	1
E		Straight Metal Holder	1
F		Safety Strip	1

Hardware

①		Bolt (M8*20mm) and Washer	5
②		Bolt and Nut and Washer and Nut Cap (M8*55mm)	1
③		Bolt and Nut and Nut Cap (M10*70)	2
④		Allen Wrench (S6)	2
⑤		Wrench (M8)	1
⑥		Wrench (M10)	2
⑦		Rubber Ring	2
⑧		U shape lock	1
⑨		Bolt and Nut (M6*45mm)	1
⑩		Bolt	1
⑪		Spring with safty lock	1
⑫		Bolt (M 8*30)	1
⑬		Wrench (M6)	1
⑭		Safety Buckle	1
⑮		Allen Wrench (S8)	1

Assembly preparation

Before Beginning Assembly:

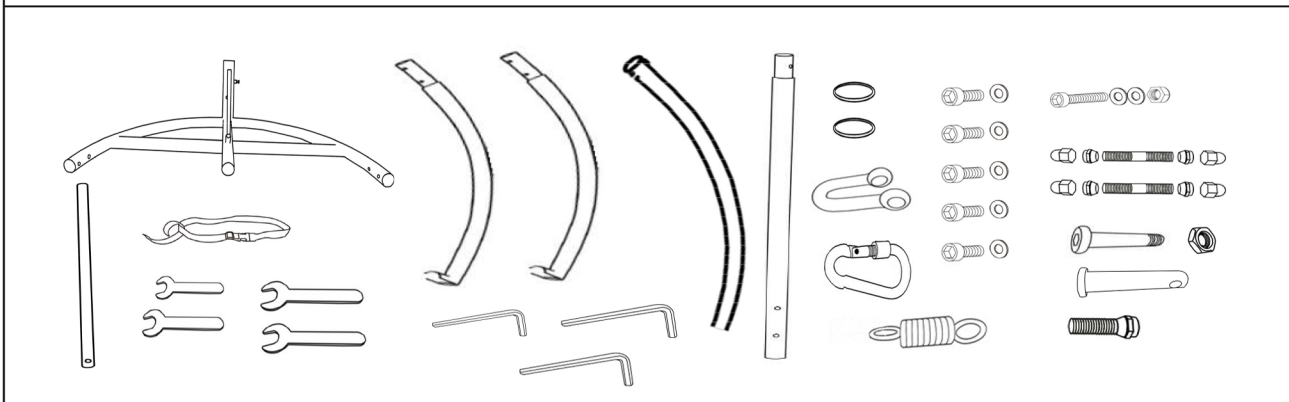



- Read instructions, cover to cover-



- Have 2 adults on hand for assembly-



- Do not assemble on flooring or carpet-



- Assemble on a clean non-marring surface (packing foam)-



- Save all packaging until finished-

Assembly Steps

Overview

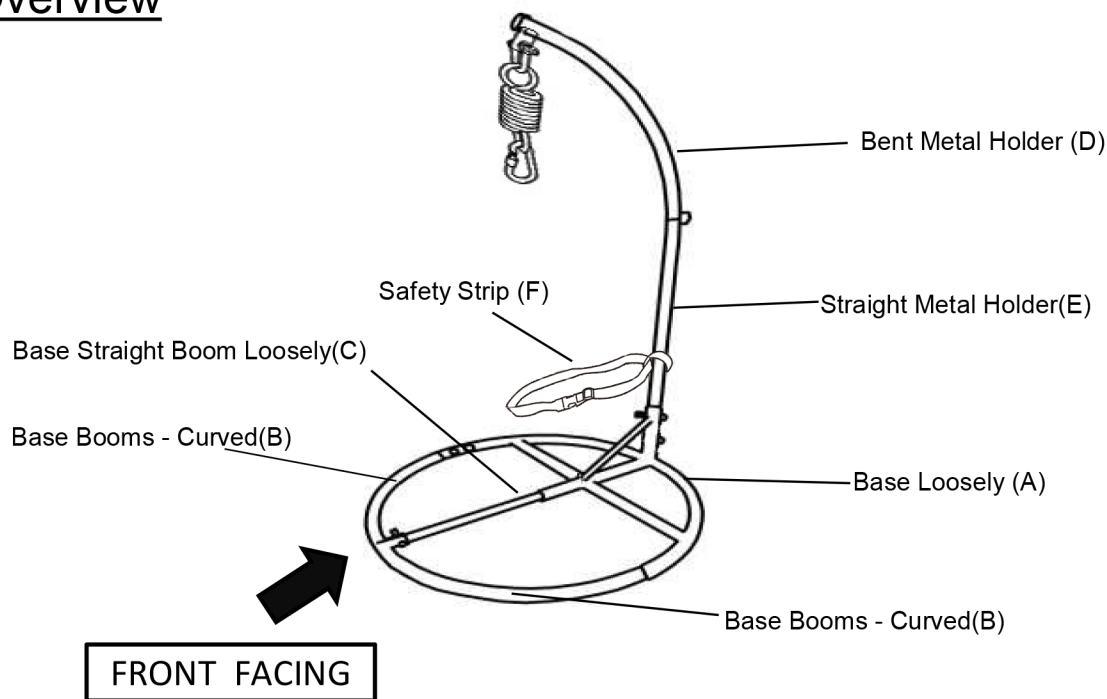

This Stand has multiple parts and may require up to 30 minutes to assemble. To give you an overview of the Table parts, the above picture is to help you put the various parts into perspective. Please read through the instructions below to familiarise yourself with the parts and steps before assembly.

Step 1

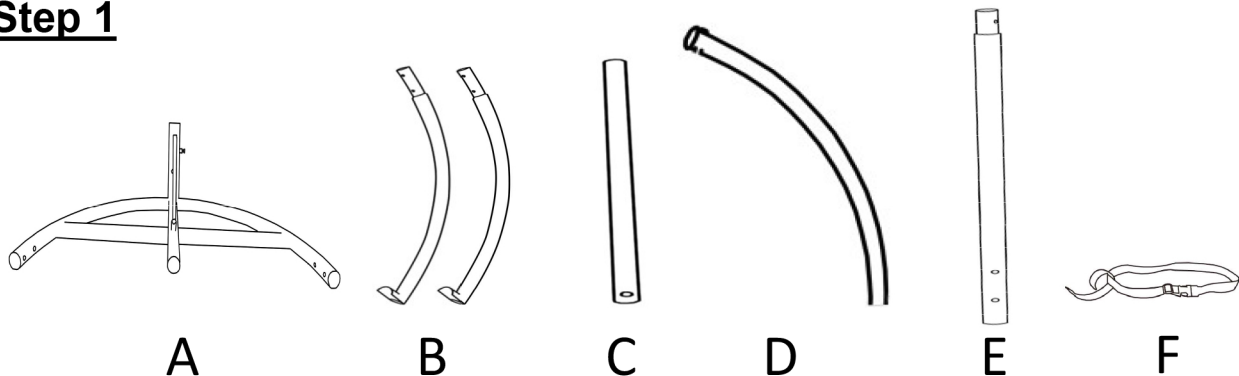

Open the carton and place all the parts on a clean, non-marring surface.

Step 2

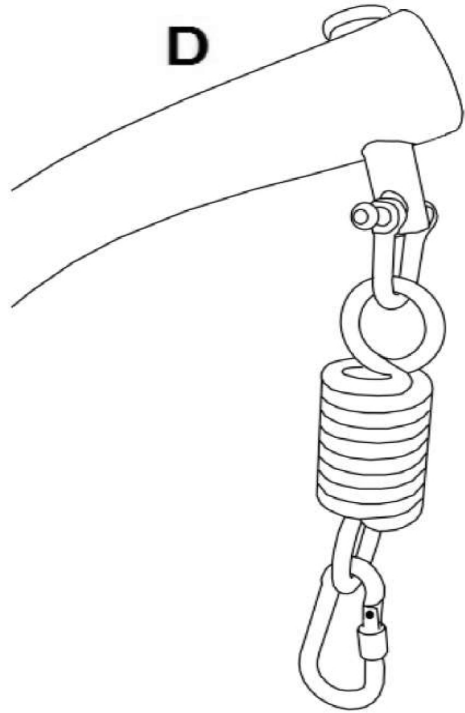
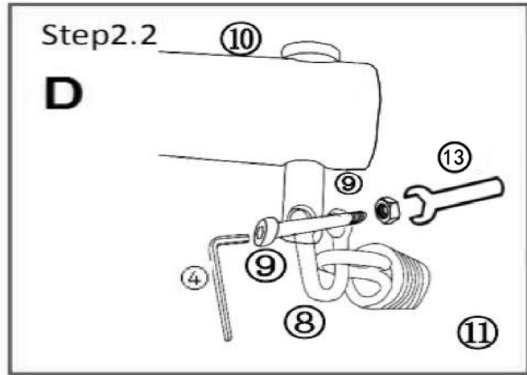
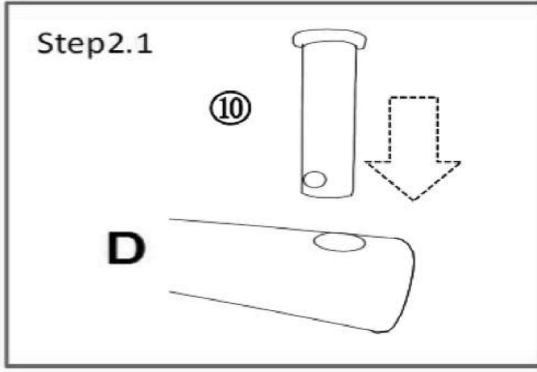

Step 2.1: Attached Bolt(⑩) to Bent Metal Holder(D).

Step 2.2: Attached U shape Lock with Spring & Safety lock(⑪) to Bolt(⑩) using Bolt and nut(⑨) with Allen Wrench (④) and Wrench (⑬).

Tighten the Bolt.

Step 3

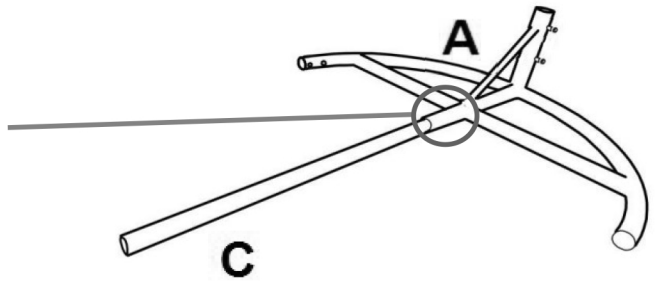
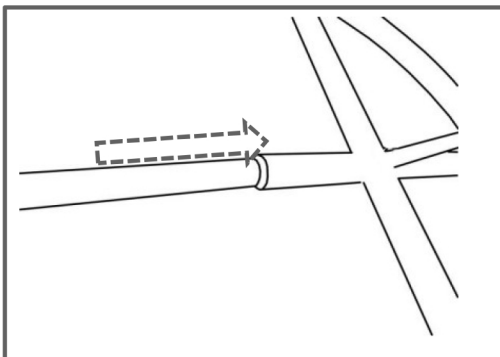

Attached Base Straight Boom Loosely (C) to Base Loosely (A).

Attention: Should Push C to the end of bottom of A

Step 4

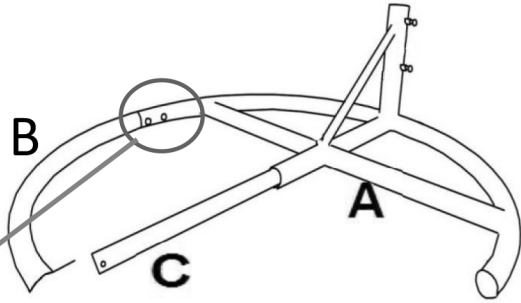
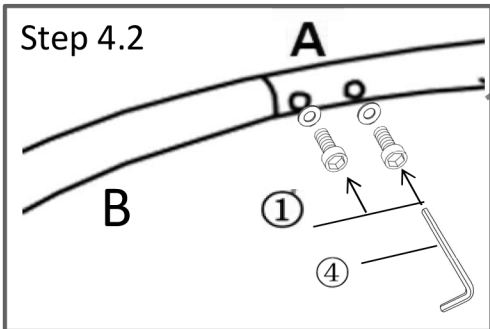
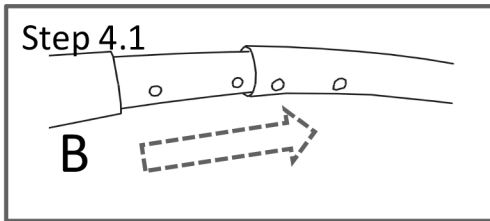

Attached Base Booms - Curved (B) to Base Loosely (A) using bolts and washer (①) with Allen Wrench (④).

Don't Fully tighten the bolts in this step.

Step 5

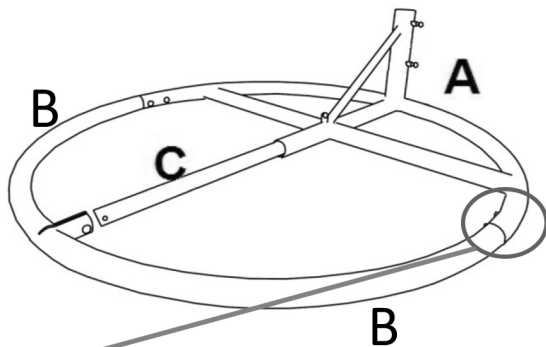
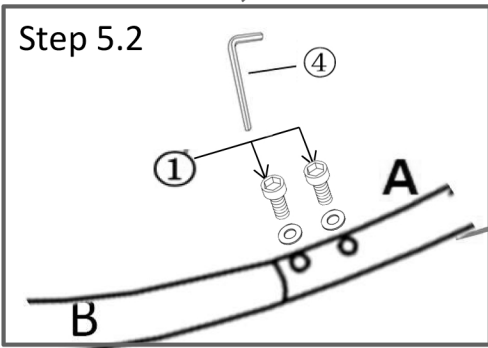
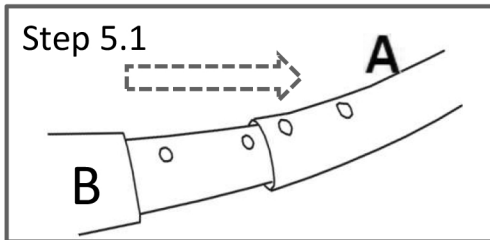

Repeat Step 4, attach another piece of Base Booms - Curved (B).

Don't Fully tighten the bolts in this step.

Step 6

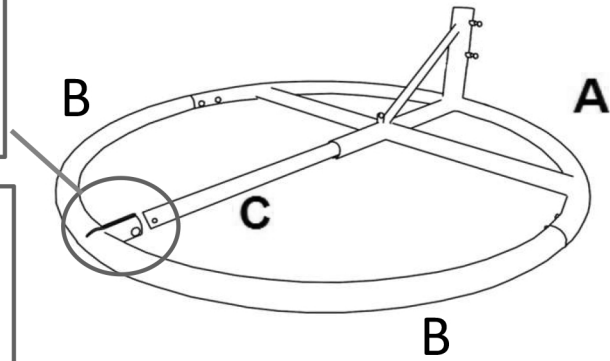
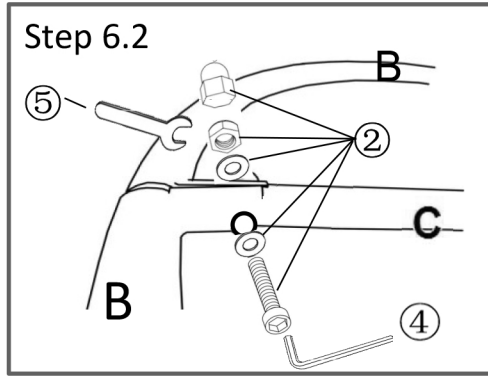
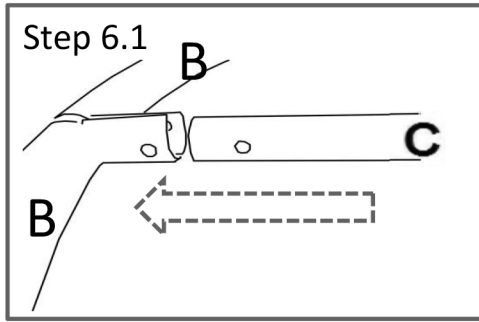

You should drag out Part (C) a little in this step, then attach Base Straight Boom Loosely (C) to Base Booms - Curved (B) using Bolt and Nut and Washer (2) with Wrench (5) and Allen Wrench (4).

Fully tighten all the bolts and nuts of this base.

After fully tightening the nut, cover the nut cap (2).

Step 7

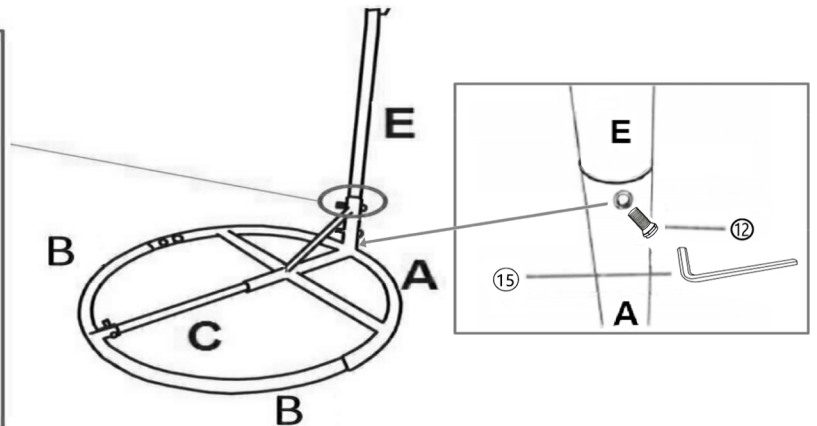
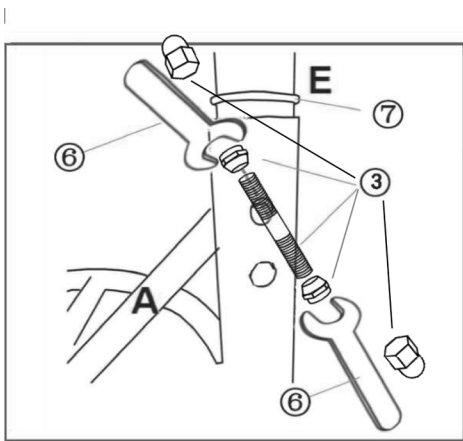

7.1: Attached Straight Metal Holder (E) to Base Loosely (A) on side mounting position by using Wrench (6) with Nuts set (3)

Then, Move the Rubber Ring (7) down the Lower Pole (E) until it is flush with the top of the Base (A).

7.2: Secure Base Loosely (A) to Straight Metal Holder (E) on front mounting position by use Bolt (12) with Allen Wrench (15) as shown above.

PS: You should loosen nuts using Wrench (6) before this step.

Cover the nuts with nut caps after tightening the nuts.

Step 8

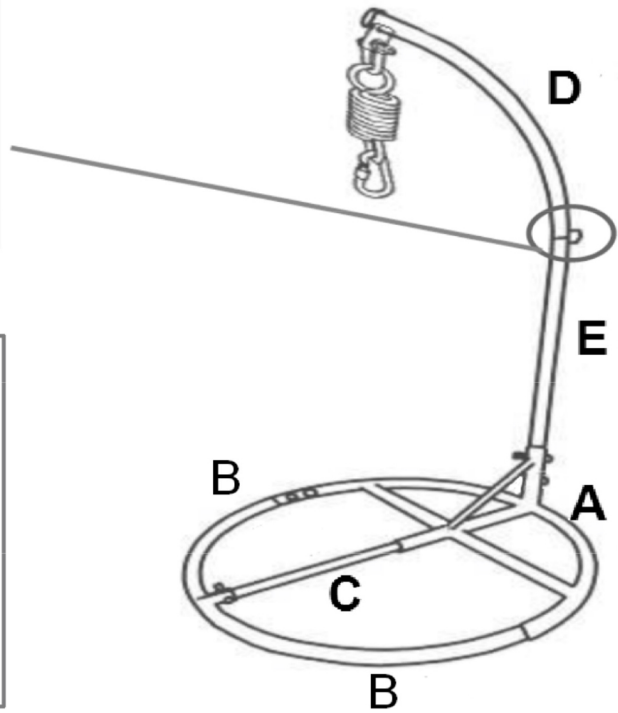
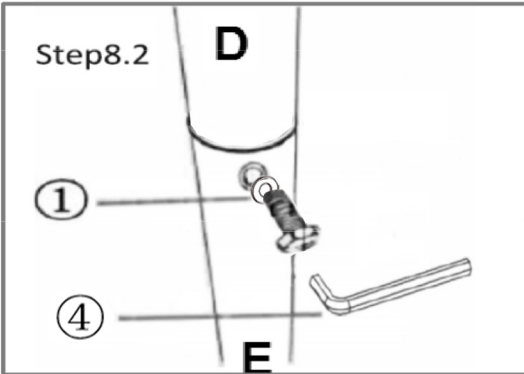
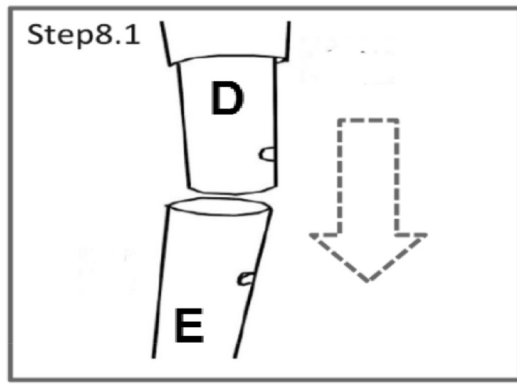

Attached Bent Metal Holder (D) to Straight Metal Holder (E) with Allen Wrench (Ⓞ) with bolt and washer(Ⓞ).

Attention: Fully tighten nuts.

Step 9

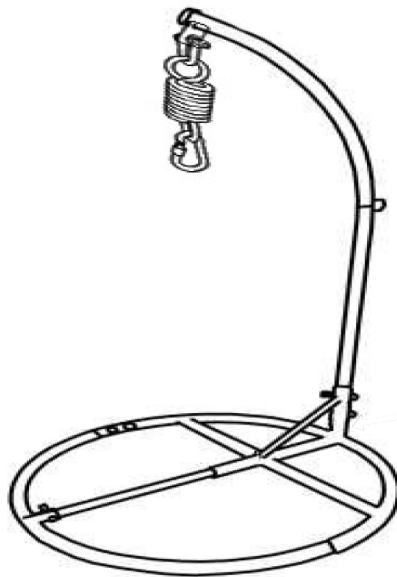

The stand are ready to use.

Step 10

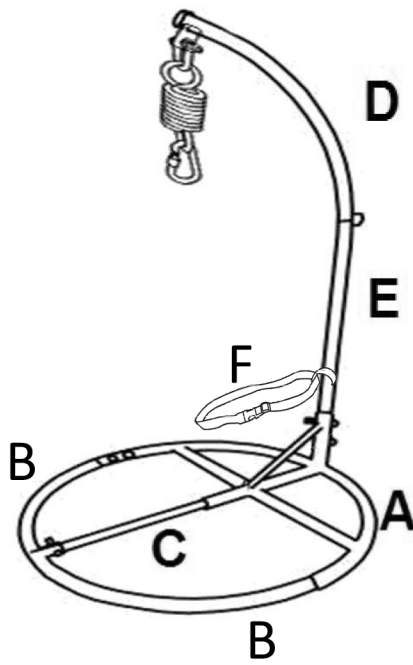

You should fasten the safety strip (F) before using .

Step 11

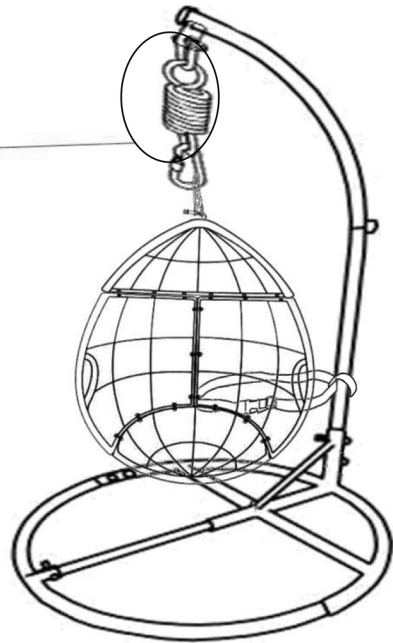
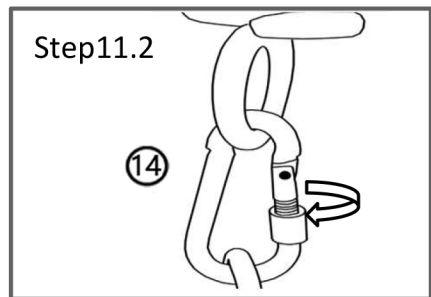
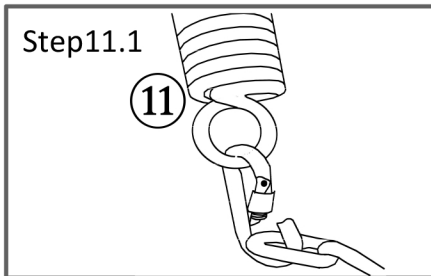

Lift the Basket and hang the Iron Chain on the Spring of the Hanging Chair Base. And Screw the Safety lock tightly.

Use the Safety Strip to lock up the middle rattan warp of the Basket as shown above.

Screw up the Carabiner to secure the Basket.

Note: This Step should be completed with 2 adults.