

DESIGNER COLLECTION

JENNIFER 7248

SIZE

72" L x 48"W x 25"D

WATER CAPACITY

90 Gallons

WEIGHT

130-170 Pounds

INSTALLATION

Drop-in

BACK SLOPE

24°

MATERIAL

Acrylic

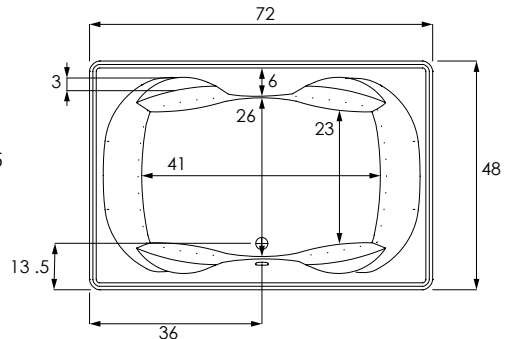
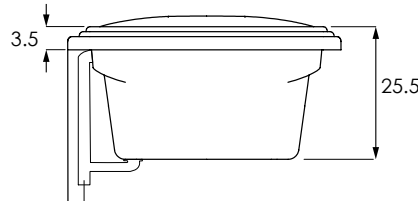
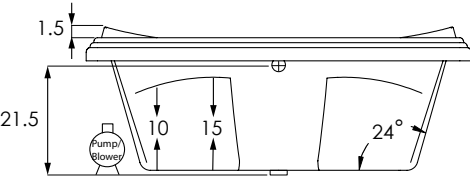

MODEL	
JEN7248ATO	Tub Only
JEN7248AWP	Whirlpool (8)
JEN7248ATA	Thermal Air
JEN7248ACO	Combo System
COLORS	
Standard	White Biscuit Bone
Premium Colors	Black Sterling Silver
FINISH	
Matte Finish	MAT (must specify if desired)
Polished Finish	STANDARD
BACK MASSEUSE SYSTEMS	
System I - Manual Control (WP/CO)	BAC.MA1-XXX
System II - Electronic Control (WP/CO)	BAC.MA2-XXX
System III - Electronic Control (TA)	BAC.MA3-XXX
COLD PLUNGE See Website for Install Form	CLD.PL
EXPORT CRATE	FRT.EXPCRT
EXTRA HIGH DENSITY	HI.DEN
GRAB BARS (Pair) Refer to price book for all available finishes	
Standard Grab Bars	GRA.BAR-XXX
Universal Grab Bars	UGB.BAR-XXX

MODEL	
HEATED BACKREST	INCLUDED ON THERMAL AIR
HYDRO BLANKET 2 Zones 3 Zones 4 Zones 5 Zones (3 or 4 zones require two keypads. 5 zones require 3 keypads)	BLA.HEA-X
HYDRO COAT	HYC.COA
HYDRO EXPRESS	69.104-HYD.EXP
HYDRO FILL (must specify location)	HYD.FIL
HYDRO FUSION	
Hydro Fusion (Tub Only)	29.102
Hydro Fusion w/ Ozone (Tub Only)	29.103
Hydro Fusion (TA, Whirlpool, Combo)	29.107
HYDRO INDULGE	HYD.IND
HYDRO OZONE UV COMBO SYSTEM Whirlpool and Combo Systems only	OZUV.XXX 110 V OZUV.110
INLINE HEATER Whirlpool and Combo Systems only No dedicated GFI required for 6 amp models	
12.50 Amps 1.5 KW - 110V	27.100
6.00 Amps 0.75 KW	27.103



Headquarters
29132 Avenue Paine
Valencia, CA 91355

Manufacturing Facility
385 Highway 155 South
McDonough, GA 30253

Technical Support
support@hydrosystem.com







Orders Department
orders@hydrosystem.com

General Information
info@hydrosystem.com

Phone: 661-775-0686

Website: hydrosystem.com

CODES AND COMPLIANCES
Massachusetts code File no: P1-0614-491







 ADA Compliant

All specifications and options subject to change without notice please contact a hydro systems representative for more information.

JENNIFER

7248

DESCRIPTION

JETS

Installed per jet price for extra jets added to standard system price. All metallic finishes come with colored eyeball.

Additional Standard or Swirling Jet JET.STD-XX | JET.SWI-XX

Color Trim
Group 1 - PC or PB
Group 2 - AB, BB, SB, BC, SC, PN, SN, BN
Group 3 - PG, BG, SG

Swirling Jet Upgrade JUP.SWI-XX
(Per jet substitution price added to standard system price)

Micro Therapy Jet MTJ.XXX
BIS, BLA, BON, SIL, WHI

Custom Jet Locations 69.116-CUS.JET
(Must include drawing of locations)

JET PLATING

Clear / Brass / Chrome. Trim kit covers jet escutcheons, suction, and electronic softtouch pad. Per jet substitution price added to standard system price. All metallic finishes come with colored eyeball.

Group 1 (PC or PB)

8 Jets PLA.08-XX
10 Jets PLA.10-XX

Group 2 (AB, BB, SB, BC, SC, PN, SN, BN)

8 Jets PLA.08-XX
10 Jets PLA.10-XX

Group 2 (PG, BG)

8 Jets PLA.08-XX
10 Jets PLA.10-XX

LED TEMP. READOUT KEYPAD

Upgrade only, must have a keypad controlled system to purchase. LED.UPG

LIGHTING

LED Bath Light Chromotherapy System LIG.LED

LOW WATER PROTECTION

Includes 30 minute timer (110V) LOW.WAT-110

NECK MASSEUSE JET PILLOW

Available in black, bone and white. PIL.NEC-XX

DESCRIPTION

PADDED HEADREST PILLOW 41.128
Black only

PUMPS 69.116-CUS.PMP
Custom Pump Locations

REMOTE CONTROL REM.CON
Must must have system to purchase

WASTE & OVERFLOW WOV.XX
Cable W/O No Charge
(WHI, BIS, PC, PB, PN, BC, BB, BN, SC, SB, SN, ORB, PE)

Cable W/O - Gold Finish Upgrade (PG, BG)

INTEGRAL W/O (Std. round) IWO.XX

Waste and overflow manufactured as part of the bath. Comes standard as a round overflow cover. Drain will be a tip-toe style and drain outlet will be a direct drain.

LINEAR INTEGRAL W/O LWO-XXX

Waste and overflow manufactured as part of the bath. Drain will be a tip-toe style and drain outlet will be a direct drain.



Headquarters
29132 Avenue Paine
Valencia, CA 91355

Manufacturing Facility
385 Highway 155 South
McDonough, GA 30253

Technical Support
support@hydrosystem.com

Orders Department
orders@hydrosystem.com

General Information
info@hydrosystem.com
Phone: 661-775-0686
Website: hydrosystem.com

CODES AND COMPLIANCES

Massachusetts code File no: P1-0614-491



All specifications and options subject to change without notice please contact a hydro systems representative for more information.

JENNIFER

7248



STANDARD ACRYLIC COLORS



WHITE BISCUIT BONE

PREMIUM ACRYLIC COLORS



BLACK STERLING SILVER

WELLNESS OPTIONS



Cold Plunge
Revitalizing cold hydrotherapy into a traditional tub



Thermal Air
Tiny bubbles into the bathwater and offers untold relaxing benefits, similar to Swedish massage



Hydro Indulge
A concentrated dose of oxygen-rich molecules cleanse and restore skin



Whirlpool Massaging Jets
Flexibility to customize jet location, quantity of jets and type of jet therapy



Back and Neck Masseur
Utilizes six strategically located jets enabling a "shiatsu" type massage and direct to the neck with 3 pulse settings



Advanced UV system
Ozone and UV light helps to disinfect the water and keep it clean



Chromotherapy
Digitally controlled, multicolored lighting feature LED lighting system



Hydro Fusion
Totally silent operation maintains ideal temperature without adding hot water constantly



Hydro Blanket
Radiant heat emanates through the acrylic tub surface. Chose up to 2-5 panels.

Drop-In Cutout Install Dimensions:

- (L)ength - 70"
- (w)idth - 46"
- Finished Height - 23"

OTHER OPTIONS

Additional options can be found on our website



Integral Waste and Overflow
Seamless built-in protection for bathtub



Grab Bars
Adds functionality and enhanced styling. Affords a mounting solution in virtually any position on any tub.

Installation Tips:

- When adding integral linear drain p-trap location is now below waste
- Adding multiple systems/options may require equipment to stick out from tub deck or be installed remotely



HYDRO SYSTEMS



Headquarters
29132 Avenue Paine
Valencia, CA 91355

Manufacturing Facility
385 Highway 155 South
McDonough, GA 30253

Technical Support
support@hydrosystem.com

Orders Department
orders@hydrosystem.com

General Information
info@hydrosystem.com

Phone: 661-775-0686
Website: hydrosystem.com

CODES AND COMPLIANCES

Massachusetts code File no: P1-0614-491



All specifications and options subject to change without notice please contact a hydro systems representative for more information.