



# MANUEL D'INSTRUCTIONS INSTRUCTION MANUAL

---

**Florence Solarium 10 PI. X 16 PI.**  
**Florence Solarium 10 FT. X 16 FT.**

sku: W1610-GP-12		
sku: W1610-GP-32		
sku: W1610-GP-42		

**NE DÉTRUISEZ PAS LES BOÎTES AVANT QUE L'ABRI SOIT COMPLÈTEMENT ASSEMBLÉ  
POUR LA RÉFÉRENCE FUTURE, PRENEZ DES PHOTOS DE TOUS LES SIX COTÉS DE CHACUNES  
DES BOITES À LA RÉCEPTION DU PRODUIT.**

**VEUILLEZ VÉRIFIER LE CONTENU DE CHAQUE BOÎTE A L'AIDE DE LA LISTE DES PIÈCES**

**10pi x 16pi / 3.04m x 4.87m Solarium**

**LES INSTRUCTIONS D'INSTALLATION**

**IMPORTANT: RETENIR POUR LA FUTURE RÉFÉRENCE, LIRE ATTENTIVEMENT**

Consultez votre autorité locale / les codes municipaux locaux concernant l'installation de structures temporaires avant l'achat ou l'assemblage. Certaines juridictions peuvent exiger des permis pour, ou réglementer autrement, l'installation et l'utilisation.

Pour l'assistance de l'assemblage, d'installation, des pièces en particulier, ou service à la clientèle, veuillez contacter Gazebo Penguin au numéro de téléphone mentionné mi-bas : (français, anglais, lun. à ven. de 8 du matin à 4 après-midi est) :

**Montréal:** (514) 276-3485

**Canada et États-Unis:** 1-800-737-7174

**ATTENTION:**

- Pour une utilisation à l'extérieur.
- La neige doit être nettoyée en tout temps, ne pas laisser s'accumuler.
- Conserver votre **preuve d'achat** pour la garantie. Veuillez **garder les boîtes** jusqu'à la fin de l'installation.
- D'assemblage peut durer plus que 4 heures et l'exige d'avoir au moins 3 personnes.

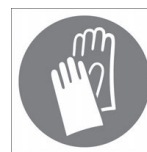

**AVANT ASSEMBLAGE:**

- Veuillez ne pas détruire les boîtes avant d'avoir terminé l'assemblage.
- La fondation doit être sous le niveau de sol, plat et solide, comme du béton ou de l'asphalte.
- Tenez à l'écart des lignes électriques aériennes, des branches d'arbres et d'autres structures.
- Vérifiez s'il y a des tuyaux ou des fils souterrains si le creusement ou le forage est nécessaire.
- Ne pas installer à proximité des lignes de toit ou d'autres structures qui pourraient jeter de la neige, de la glace ou une pluie excessive sur le toit.
- Assemblez la structure près du point final d'utilisation la plus proche possible.
- Il est recommandé de porter des gants de sécurité, des lunettes de sécurité et des casques de protection pour l'installation.
- Ne vous suspendez pas, ne grimpez pas et ne vous tenez pas debout sur la structure ou le toit.
- Avant le montage, lisez les instructions et vérifiez que toutes les pièces sont présentes dans les boîtes. S'il manque des pièces, svp, contactez notre département de garantie.
- Un escabeau de 6 pieds (1,8 m), un tournevis Phillips, un ruban à mesurer, un niveau, un maillet et une bâche sur laquelle placer les pièces seront nécessaires pour l'assemblage (non inclus).
- Enlevez le film protecteur supérieur des panneaux de toit avant l'assemblage; NE PAS retirer le film protecteur inférieur avant d'être prêt à insérer les panneaux de toit, afin d'identifier le côté supérieur.

**INSTRUCTION D'ANCRAGE:**

- Un ancrage adéquat du cadre à la base et au mur est nécessaire pour la sécurité.
- Une structure non solidement ancrée a un risque de s'envoler lors de vents violents causant des dommages et des risques pour la sécurité.
- Le matériel et les outils requis pour l'ancrage varient en fonction de l'emplacement d'installation et ne sont pas fournis.
- Veuillez vérifier auprès de votre quincaillerie locale les ancrages appropriés à votre surface.

**SOIN ET MAINTENANCE:**

- En cas de pièce défectueuse ou endommagée, ou pour toute autre question concernant le produit, veuillez contacter directement le fabricant.
- Veuillez avoir la liste des pièces et les numéros de pièces à portée de main lors de la commande ou de la demande de pièces de rechange.

**PANNEAUX DE TOIT:**

















- Nettoyez doucement avec une solution savonneuse écologique et de l'eau à l'aide d'une éponge.
- N'utilisez pas de matériaux abrasifs, de brosses métalliques, de produits chimiques, de nettoyeurs puissants ou d'eau de javel.
- Rincer à l'aide d'un tuyau d'arrosage et sécher à l'air. S'il est retiré, assurez-vous qu'il est complètement sec avant le stockage.
- N'utilisez pas de nettoyeur haute pression.



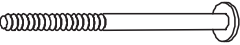
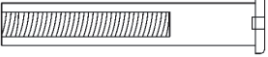
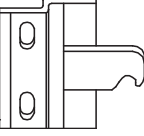
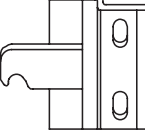

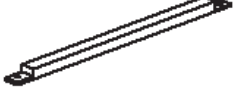

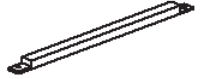



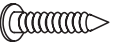

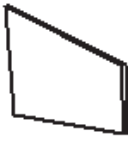
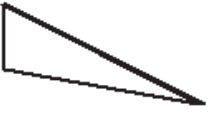
**STRUCTURE:**

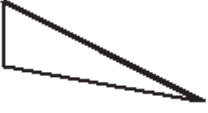

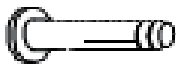
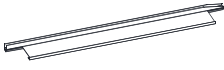
- Nettoyez doucement avec une solution savonneuse écologique et de l'eau à l'aide d'une éponge.
- N'utilisez pas de matériaux abrasifs, de brosses métalliques, de produits chimiques, de nettoyeurs puissants ou d'eau de javel.
- Rincer à l'aide d'un tuyau d'arrosage et sécher à l'air. N'utilisez pas de nettoyeur haute pression.
- S'il y a des imperfections voir le numéro de pièce de la peinture dans la liste des pièces pour obtenir une peinture de retouche correspondante.

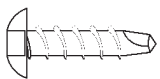

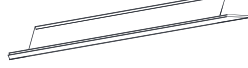







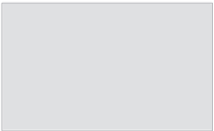
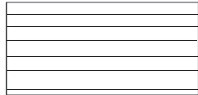

## SOLARIUM W1610 ½

DESCRIPTION	EMBALLE DANS LA BOITE	QTÉ	DESSIN	DESCRIPTION	EMBALLE DANS LA BOITE	QTÉ	DESSIN
23-093 CADRE RÉGULIER A-3	2	2		23-094 CADRE ADJACENT À LA PORTE B-3	2	1	
	3	2			3	1	
23-099 DEMI CADRE A-3 1/2	2	1		23-095 PORTE COULISSANTE C-3	2	1	
	3	1			3	1	
10-499 CADRE POUR PORTE COULISSANTE D-3	2	1		11-544 PIÈCE DE CONNECTION E-3	4	14	
	3	1					
11-545 RAIL DE PORTE SUPÉRIEUR F-3	4	2		11-546 RAIL DE PORTE INFÉRIEUR G-3	4	2	
08-138 BUTOIR EN PLASTIQUE H-3	5	4		12-142 RÉCEPTEUR GAUCHE I-3	4	1	
12-143 RÉCEPTEUR DROIT J-3	4	1		10-502 JOINT D'ANGLE K-3	4	2	
12-157 POUTRE GAUCHE L-1	4	1		12-156 POUTRE DROITE L-2	4	1	
10-532 RAIL AU MUR ML-3	4	1		10-533 RAIL AU MUR MR-3	4	1	
10-505 JOINT POUR RAIL N-3	5	1		10-506 CROCHET POUR CHEVRON O-3	5	6	
12-007 JOINT POUR PIGNON GAUCHE P-3	5	1		12-008 JOINT POUR PIGNON DROIT Q-3	5	1	

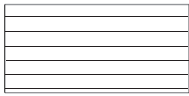
DESCRIPTION	EMBALLE DANS LA BOITE	QTÉ	DESSIN	DESCRIPTION	EMBALLE DANS LA BOITE	QTÉ	DESSIN
10-509 EMBOUR CHEVRON DE R-3	5	9		12-146 CHEVRON GAUCHE S-3	4	1	
12-147 CHEVRON DROIT T-3	4	1		12-148 CHEVRON RÉGULIER U-3	4	7	
10-513 JOINT CENTRAL POUR TOIT V-3	5	2		10-514 JOINT CENTRAL POUR TOIT W-3	5	6	
10-515 BORDURE DE FINITION X-3	5	2		10-516 BORDURE DE FINITION Y-3	5	6	
08-156 VIS Z-3	5	14	 M4*16mm	25-114 BOULON Bb-3	5	32	 (M6*16mm)
25-115 BOULON Cc-3	5	25	 (M6*73mm)	25-117 VIS FEMELLE Cc-3-2	5	12	 M5*60mm
08-165 LOQUET POUR PORTE DROIT Dd-R-3	5	2		08-169 LOQUET POUR PORTE GAUCHE Dd-L-3	5	2	
25-119 BOULON Ff-3	5	20	 (M6*12mm)	08-187 RONDELLE Gg-3	5	25	
10-517 BARRE TRANSVERSALE EXTRÉMITÉ Jj-3	5	2		10-518 BARRE TRANSVERSALE RÉGULIÈRE Kk-3	5	6	
10-519 RENFORT POUR TOIT LI-3	5	2		10-520 RENFORT POUR TOIT Mm-3	5	6	

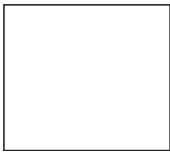
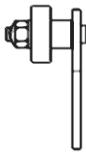
DESCRIPTION	EMBALLE DANS LA BOITE	QTÉ	DESSIN	DESCRIPTION	EMBALLE DANS LA BOITE	QTÉ	DESSIN
08-134 EMBOUIT DU RAIL DE PORTE SUPÉRIEUR Nn	5	4		08-135 VIS Oo-3	5	8	 (M4*12mm)
12-149 (63 ¼ x 24 ½") PANN. DE TOIT GAUCHE+DROIT Pp-3	1	4		12-150 (63 ¼ x 23") PANN. DE TOIT RÉGULIER Qq-3	1	12	
25-209 PANN. PIGNON ARRIÈRE GAUCHE Rr-3	1	1		25-210 PANN. PIGNON AVANT GAUCHE Ss-3	1	1	
25-211 PANN. PIGNON ARRIÈRE DROIT Tt-3	1	1		25-212 PANN. PIGNON AVANT DROIT Uu-3	1	1	
10-527 GUIDE MURAL GAUCHE Vv-3	4	1		10-528 GUIDE MURAL DROIT Ww-3	4	1	
10-529 VIS POUR ATTACHER AU MUR Xx-3	5	26		10-530 REBOUCHEUR RÉGULIER Yy-3	5	6	
10-531-L REBOUCHEUR POUR EXTRÉMITÉ Zz-3-L	5	1		25-118 BOULON Ww	5	12	 (M5*15mm)
13-045 VIS AUTO- TARAUDEUSE PQ-3	5	4		12-161 ECROU PPUR 12-160 Hh-3-2	5	4	
10-531-R REBOUCHEUR POUR EXTRÉMITÉ Zz-3-R	5	1		23-007 BOUCHON EN PLASTIQUE Kk	5	4	

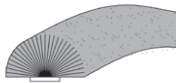
DESCRIPTION	EMBALLE DANS LA BOITE	QTÉ	DESSIN	DESCRIPTION	EMBALLE DANS LA BOITE	QTÉ	DESSIN
23-215 Clé Hexagonale QQ	5	1	 4#	25-198 Lame à Ressort PP	5	40	
23-223 Clé Hexagonale RR	5	1	 3#				

AVAILABLE REPLACEMENT PARTS			
DESCRIPTION	DRAWING	DESCRIPTION	DRAWING
10-435 FENÊTRE PVC (en cadre)		85-014 REPLACEMENT DE MOUSTIQUAIRE (pas de cadre)	
12-176 FENÊTRE PVC POUR MOITIÉ CADRE A-31/2		85-417-S SPLINE RONDE POUR LE MOUSTIQUAIRE	
10-493 FENÊTRE PVC (matériel de remplacement uniquement)		23-096 PANNEAU PLASTIQUE INFÉRIEUR (pour panneaux muraux)	
85-417-P SPLINE RONDE POUR LA FENÊTRE PVC		23-097 PANNEAU PLASTIQUE INFÉRIEUR (pour portes)	
15-123 GOUPILLE DE FENETRE		23-099 PANNEAU PLASTIQUE INFÉRIEUR POUR MOITIÉ CADRE A-3 1/2	
13-055 FENÊTRE PC (pour porte coulissante)		15-097 MONTAGE DE ROUE DE PORTE	
12-174 MOUSTIQUAIRE (en cadre)		10-458 COUPE-FROID DE REPLACEMENT 124"	
12-175 MOUSTIQUAIRE POUR MOITIÉ CADRE A-3 1/2		15-125 SUPPORT DE MONTAGE POUR CHEVRON (U-3)	
<b>*PAS INCLUS DANS LA BOITE</b>			
<b>DESCRIPTION</b>	<b>COULEUR</b>	<b># DE PIÈCE</b>	
PEINTURE À SPRAY	SABLE	11-699	
STYLO À PEINTURE		18-245	

NOTE: LES DIMENSIONS SONT APPROXIMATIVES.

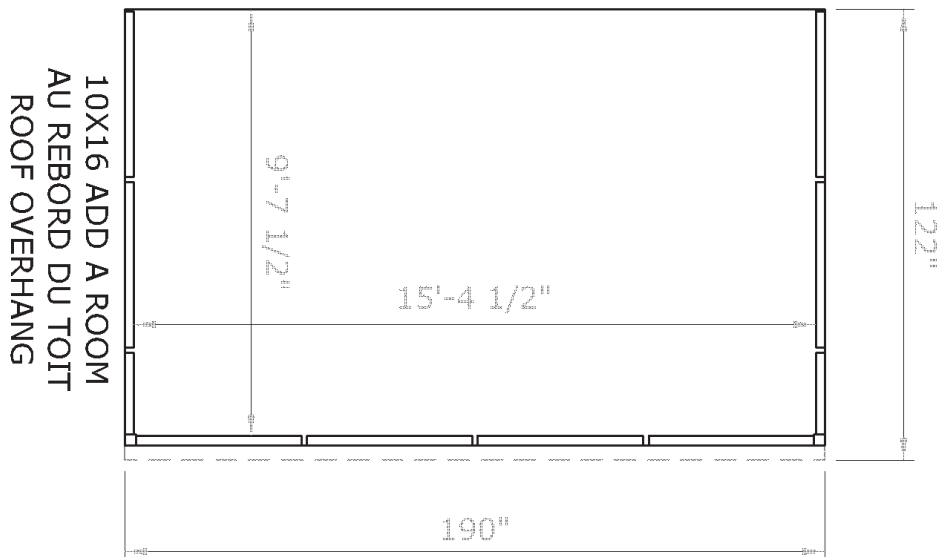
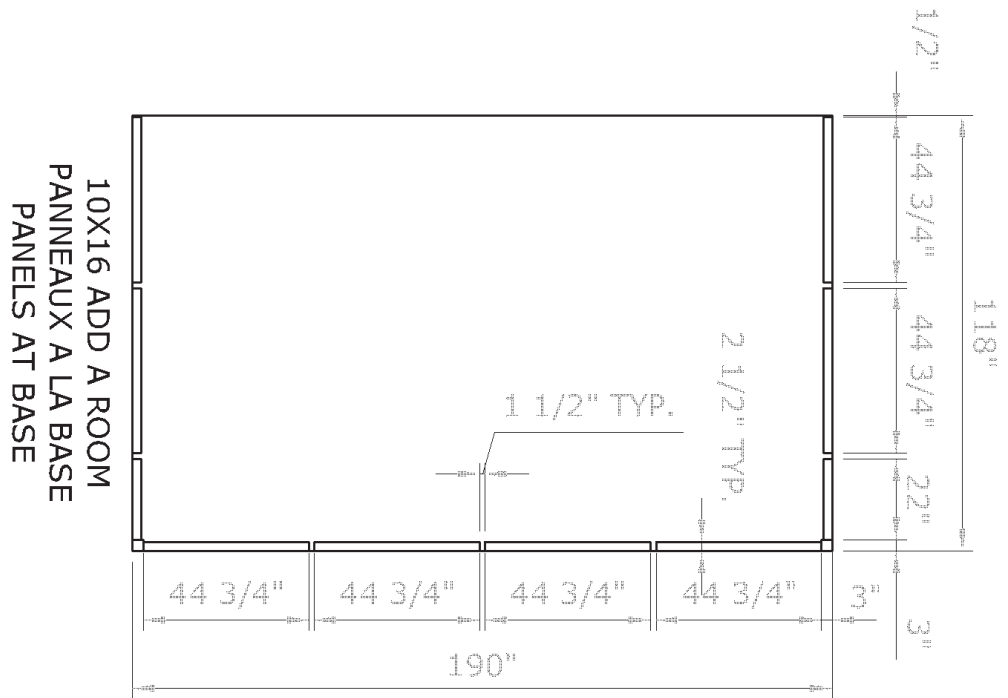

ENLEVEZ L'AUTOCOLLANT AVANT L'ASSEMBLAGE

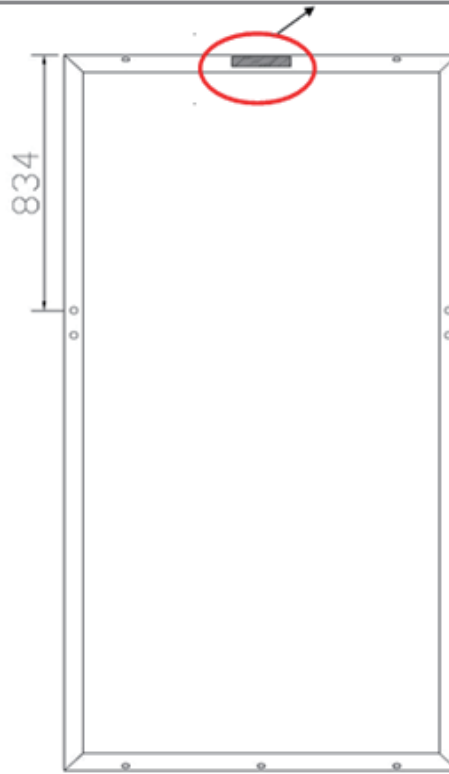
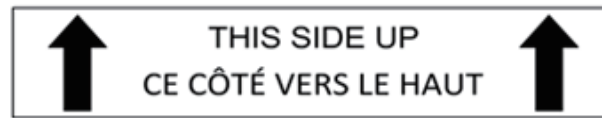

D-3 FRAME

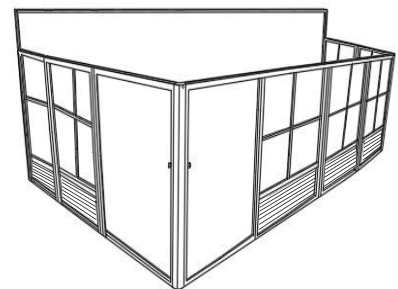
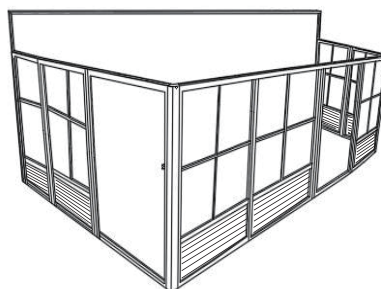
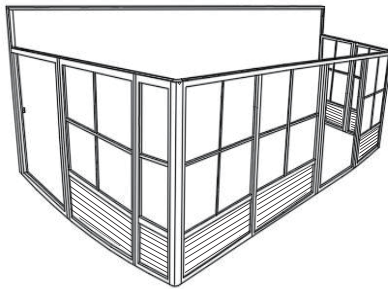

Voici quelques possibilités

La porte coulissante peut être placée à n'importe où, à condition que le cadre adjacent de la porte est à côté de la porte.

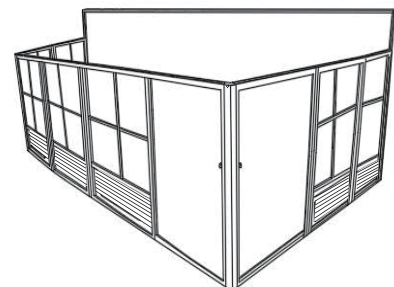
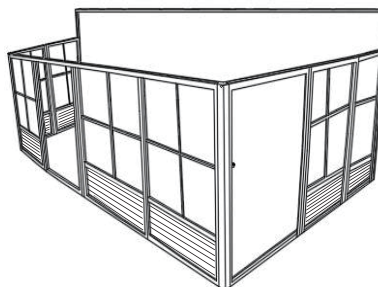
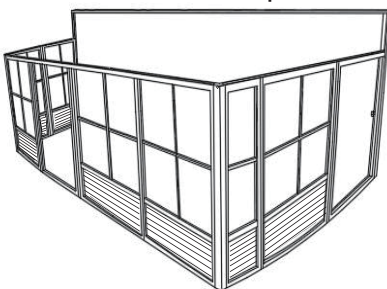

## Voici quelques possibilités

La porte coulissante peut être placée à n'importe où, à condition que le cadre adjacent de la porte est à côté de la porte.

### OUTILS REQUIS:

- Tournevis (Phillips #2)
- Couteau, Lime (douce)
- Pincettes à bec effilé
- Maillet en caoutchouc
- Échelle (Minimum de 6 pi de hauteur)
- Spatule
- Perceuse électrique
- Tube de silicone
- Foret de 5/16 pour ciment (selon la surface).

### AVANT DE COMMENCER:

Assurez-vous d'avoir une base solide comme du ciment ou un patio en bois qui n'ait pas plus d'inclinaison que 1 po par 8 pi

Ne placez pas le solarium en dessous d'un arbre ou la pente d'un toit la neige ou la glace pouvant glisser et causer l'effondrement du solarium  
Ne détruisez pas les boîtes avant que l'abri soit complètement assemblé  
Veuillez vérifier le contenu de chaque boîte à l'aide de la liste des pièces.

## **Sens de placement de la porte :**

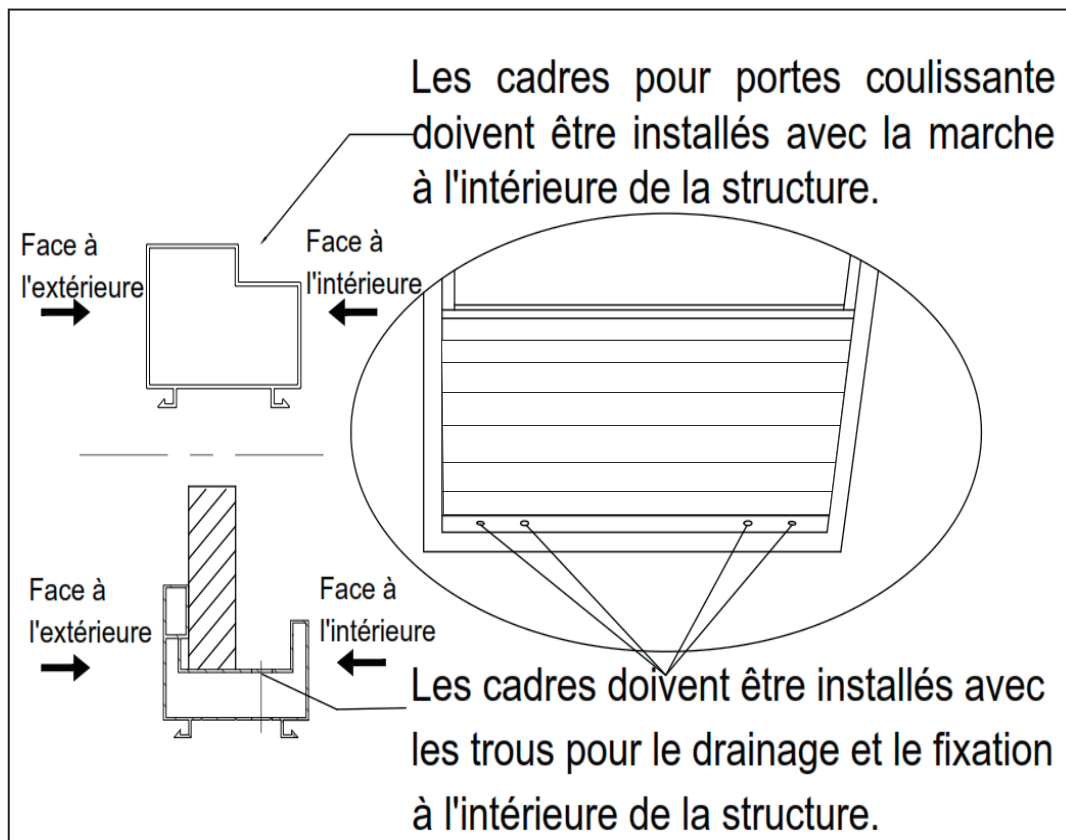

# Étape 1

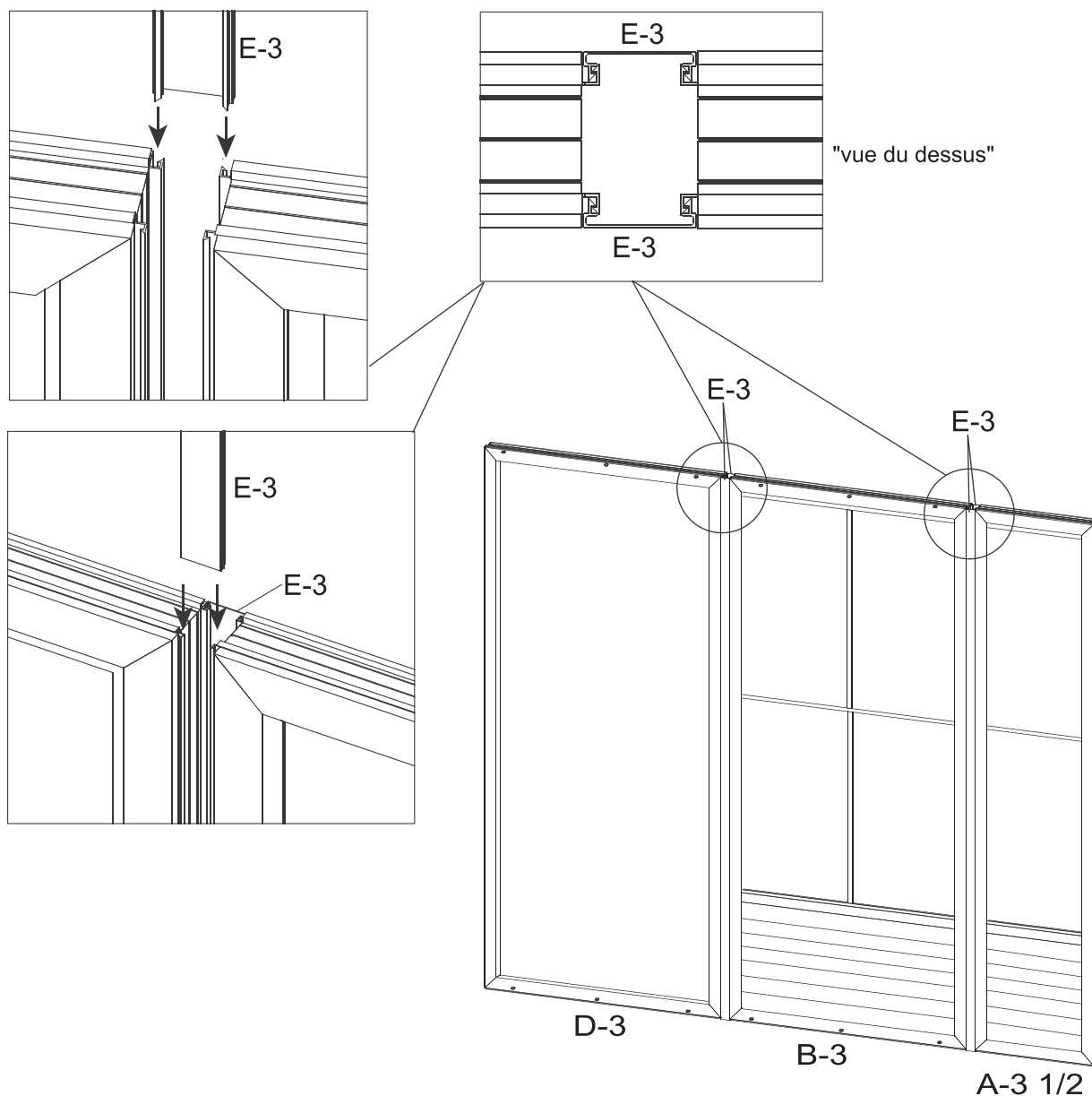

1.1 Avant le montage, déterminez la position des encadrements de porte en fonction de l'endroit où vous souhaitez glisser la porte. À l'avant du solarium, utilisez l'encadrement D3 pour l'ouverture de la porte et B3 pour l'orientation de la porte lorsqu'elle est ouverte.

1.2 Alignez le cadre de la porte coulissante (D-3) avec le cadre à côté de la porte (B-3), puis insérez la pièce de liaison (E-3) entre le cadre de la porte coulissante (D-3) et le cadre de la porte (B-3). Alignez la porte (B-3) avec le cadre à côté de la porte (A-3 1/2), puis insérez la pièce de liaison (E-3) entre la porte (B-3) et le cadre à côté de la porte (A-3 1/2).

## REMARQUE :

Lorsque vous faites glisser les connecteurs, secouez le cadre pour qu'ils glissent facilement. N'utilisez pas d'outils pour les forcer. Si nécessaire, nettoyez la peinture à l'aide d'une lime et assurez-vous que les extrémités du cadre et les joints ne sont pas tordus ou déformés. Si c'est le cas, utilisez la pince à bec effilé pour les redresser.

## Étape 2

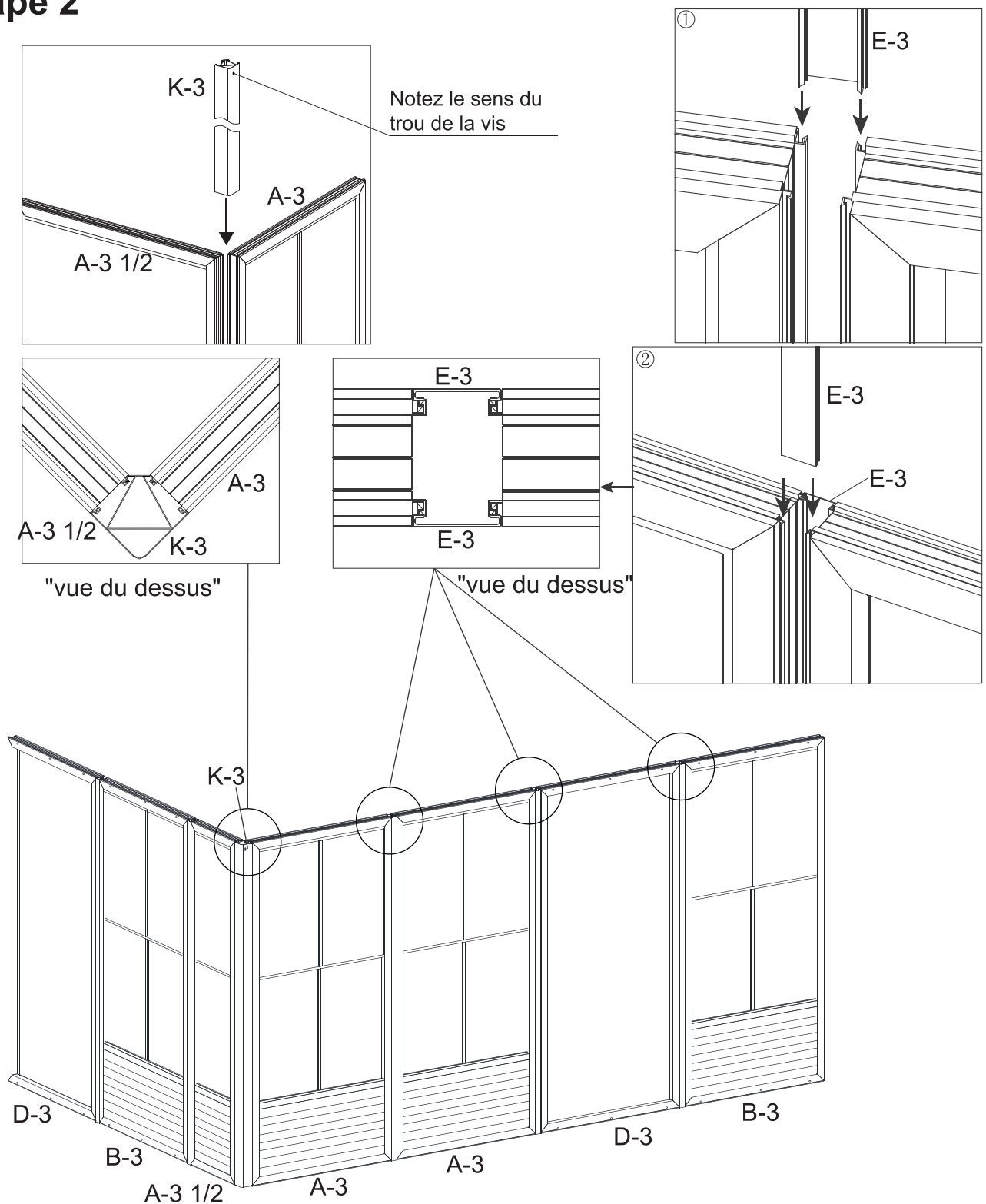

2. Fixer le cadre régulier (A-3), le cadre de la porte coulissante (D-3) et le cadre à côté de la porte (B-3) avec le connecteur d'angle (K-3) et la pièce de liaison (E-3), le joint d'angle (K-3) avec les trous de boulons orientés vers le haut et l'extérieur. Le cadre de porte coulissante (D-3) avec autocollant avec flèche pointant vers le haut (voir le schéma à la page 8).

**REMARQUE:** Lors du placement de l'ouverture du cadre de la porte, veillez à ce que les inserts du cadre se trouvent à l'intérieur et sur la moitié supérieure du cadre du solarium, car la porte sera placée à l'intérieur en raison de l'espace libre.

## Étape 3

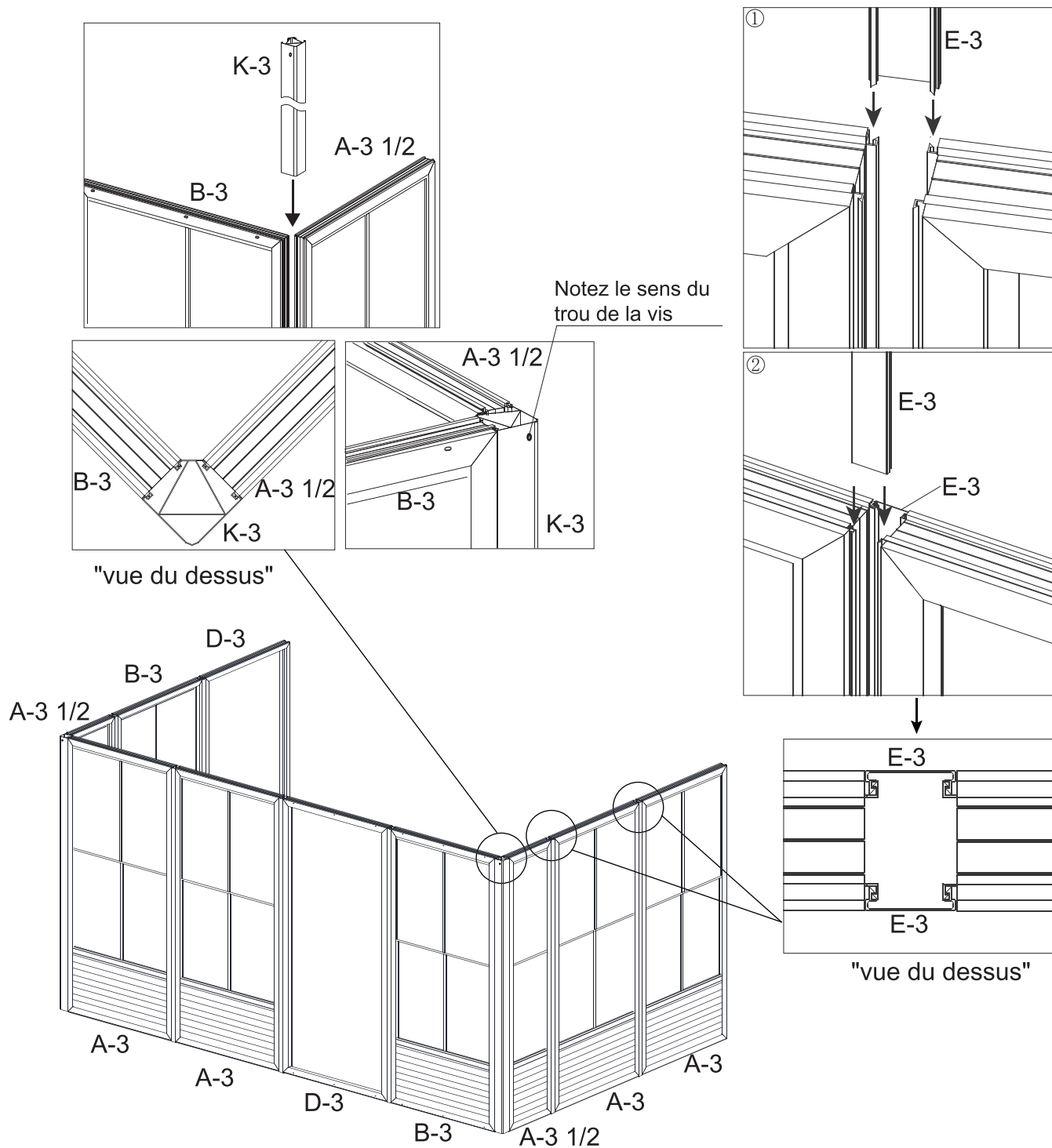

3. Relier les cadres réguliers (A-3) et les cadres (A-3 1/2) restants avec le connecteur d'angle (K-3) et la pièce de liaison (E-3). (Voir le croquis à la page 8).

**REMARQUE :** Lors du positionnement de l'ouverture du cadre de la porte, veillez à ce que les inserts du cadre se trouvent à l'intérieur et sur la moitié supérieure du cadre du solarium, car la porte sera placée à l'intérieur en raison de l'espace libre.

## Étape 4

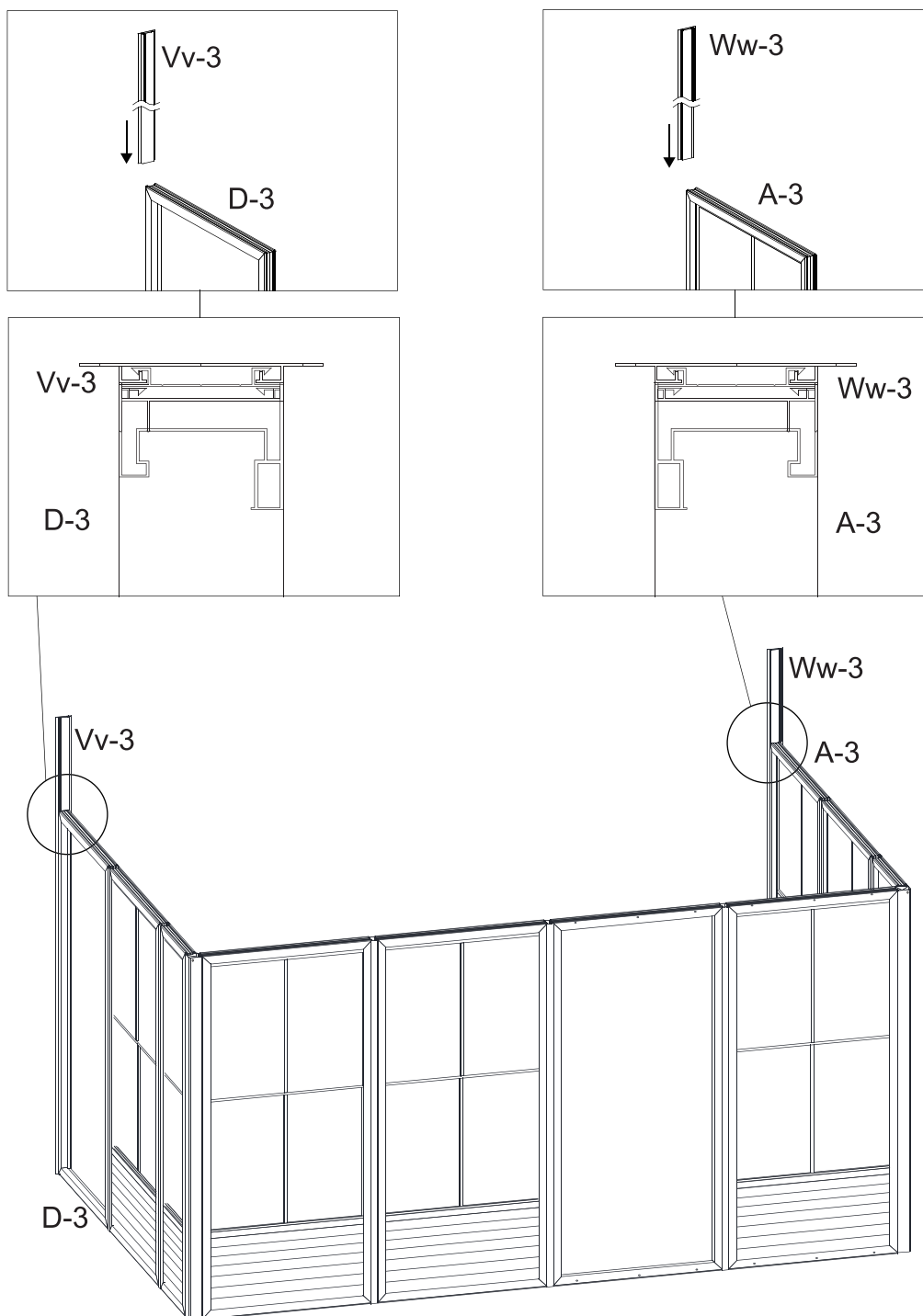

4. Faire glisser le guide mural gauche (Vv-3) et le guide mural droit (Ww-3) dans les deux extrémités des cadres le long des rainures, en les secouant pour faciliter le mouvement.  
REMARQUE : les rainures doivent rester à l'extérieur sur Vv-3 et Ww-3.

## Étape 5

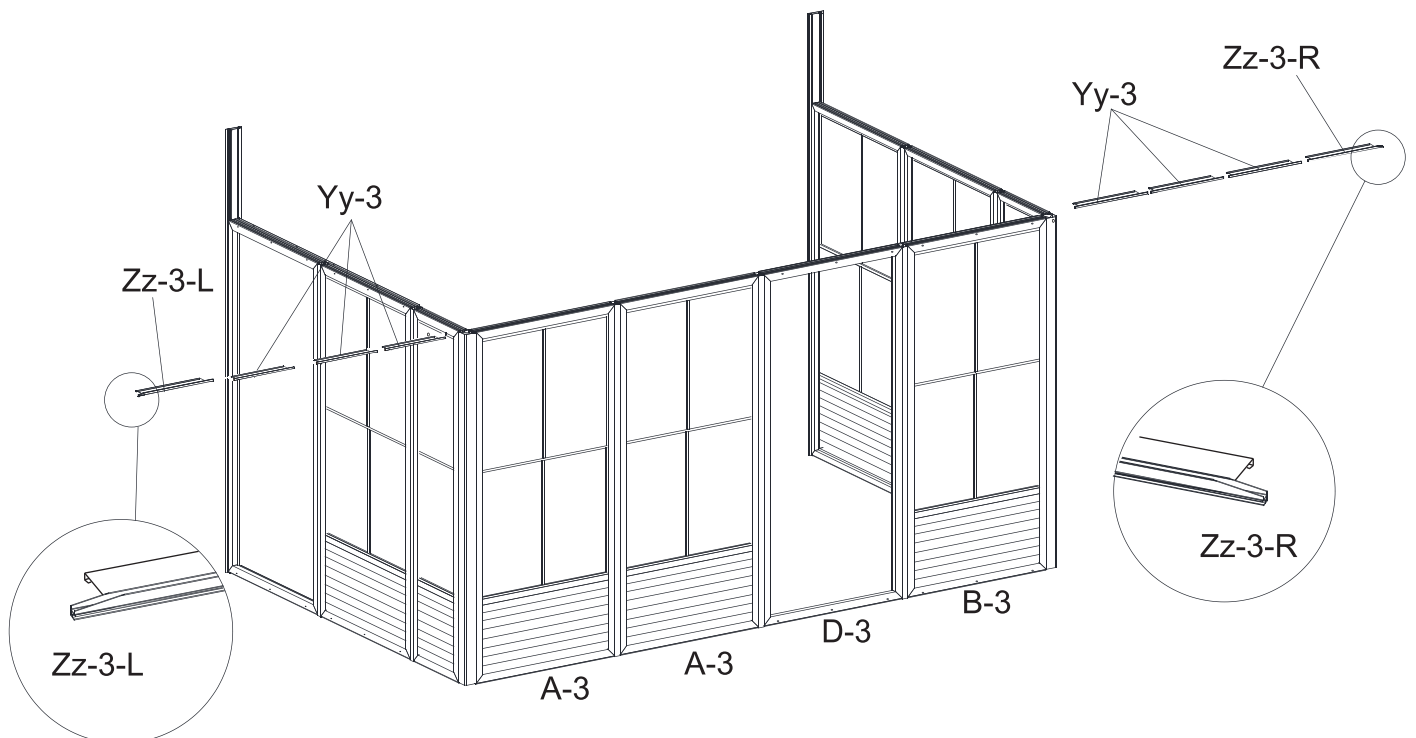
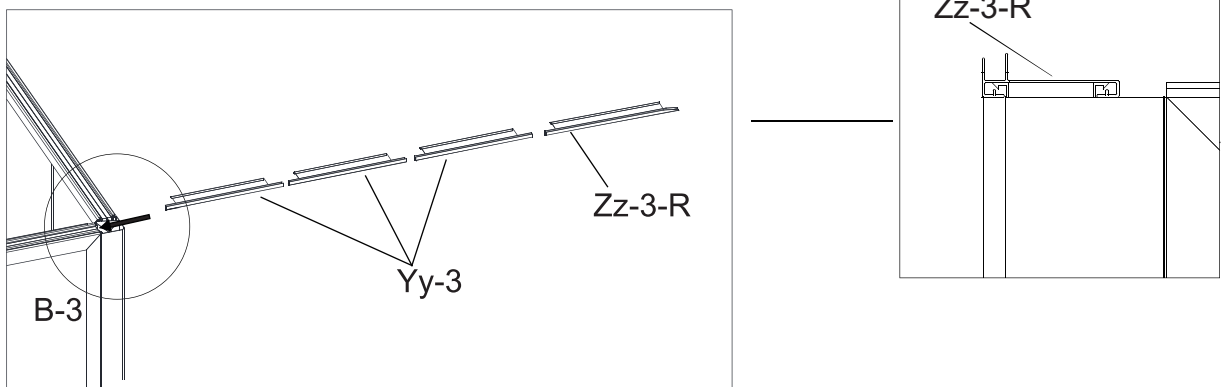
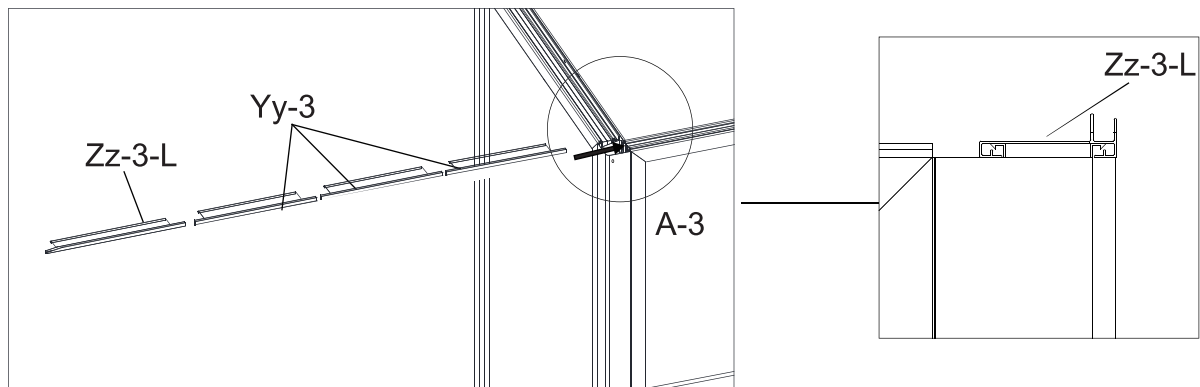

5. Faites glisser trois éléments de REBOUCHEUR RÉGULIER (Yy-3) et un élément de REBOUCHEUR POUR EXTRÉMITÉ (Zz-3-L) de la gauche vers la droite sur le dessus du cadre. La rainure doit être orientée vers l'intérieur de l'appareil. Répéter l'opération à partir du côté droit avec deux éléments de REBOUCHEUR RÉGULIER (Yy-3) et un élément de REBOUCHEUR POUR EXTRÉMITÉ (Zz-3-R), en les espaçant uniformément.

## Étape 6

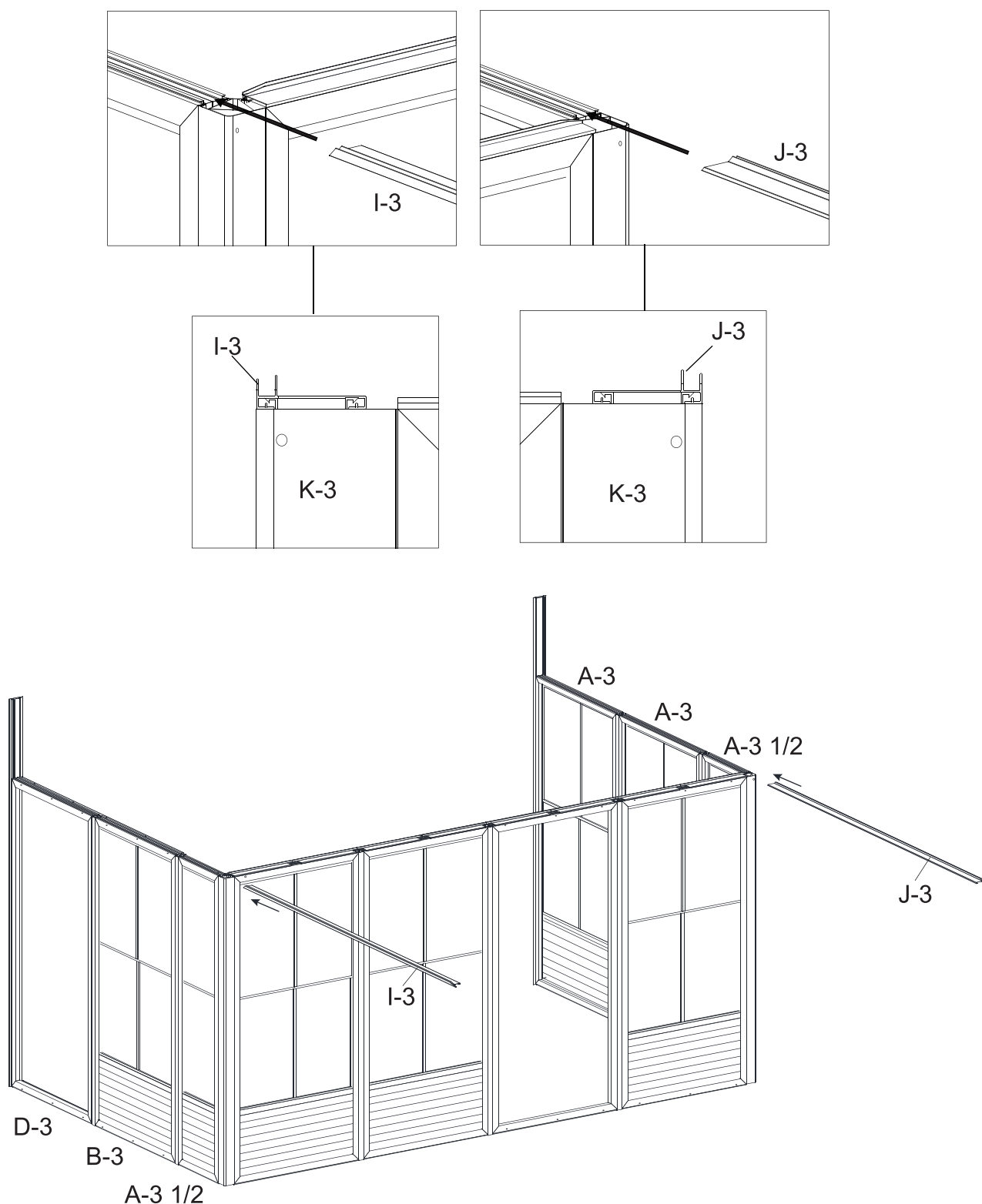

6. Insérez le récepteur latéral gauche (I-3) et le récepteur latéral droit (J-3) en haut du cadre. Assurez-vous que les deux cadres sont au bon niveau, sinon utilisez des cales pour compenser. Ne pas utiliser d'outils pour les forcer en place.

## Étape 7

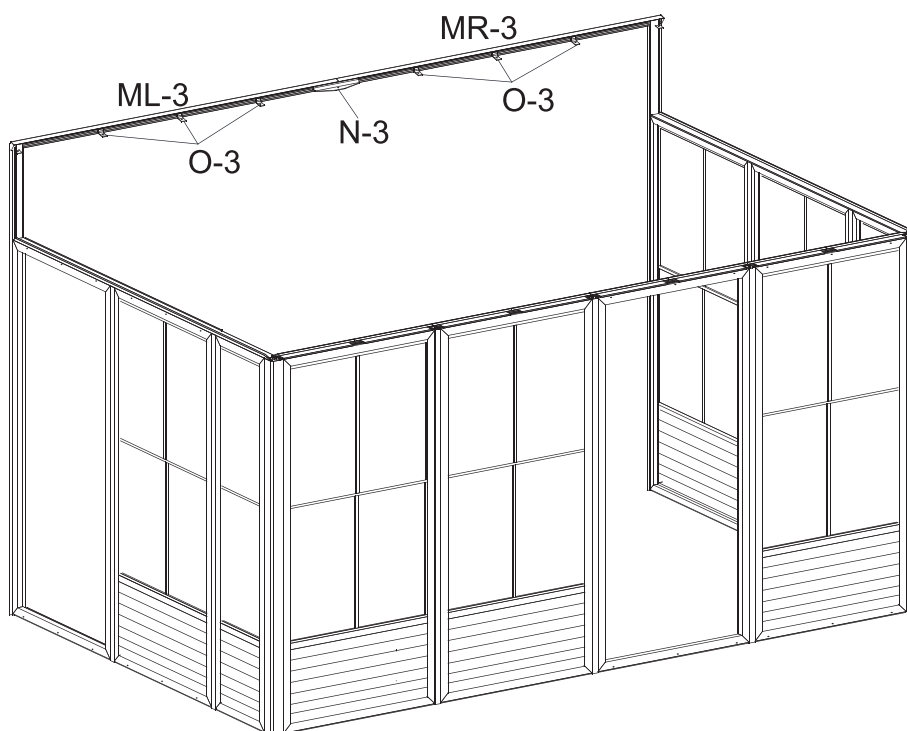
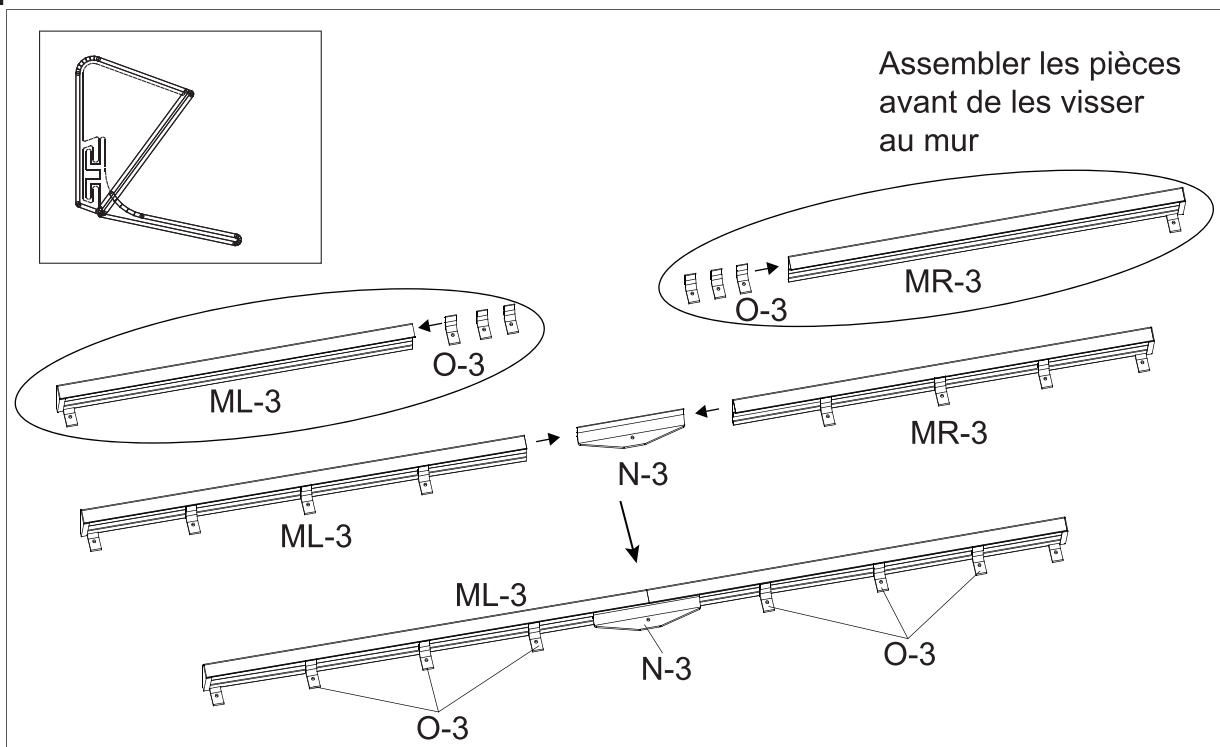

7. Assembler les ML-3, N-3, O-3 et MR-3 comme indiqué et les positionner uniformément au-dessus des guides verticaux, à 97" du sol. Fixez le rail mural et les rails verticaux au mur en briques ou en ciment en perçant l'aluminium à intervalles de 16" (minimum) et en utilisant des vis Xx-3 ou d'autres fixations en fonction du matériau du mur (non fournies). Insérez les 2 guides horizontaux, I3 & J3 en haut du cadre. S'assurer que les 2 cadres sont au bon niveau, si ce n'est pas le cas, utiliser des cales pour compenser.

Ne pas utiliser d'outils pour les forcer en place.

**REMARQUE** : Une fois le rail mural en place, appliquez du silicone le long de la partie supérieure du rail mural et à la jonction des deux rails verticaux.

**Le silicone n'est pas fourni.**

## Étape 8

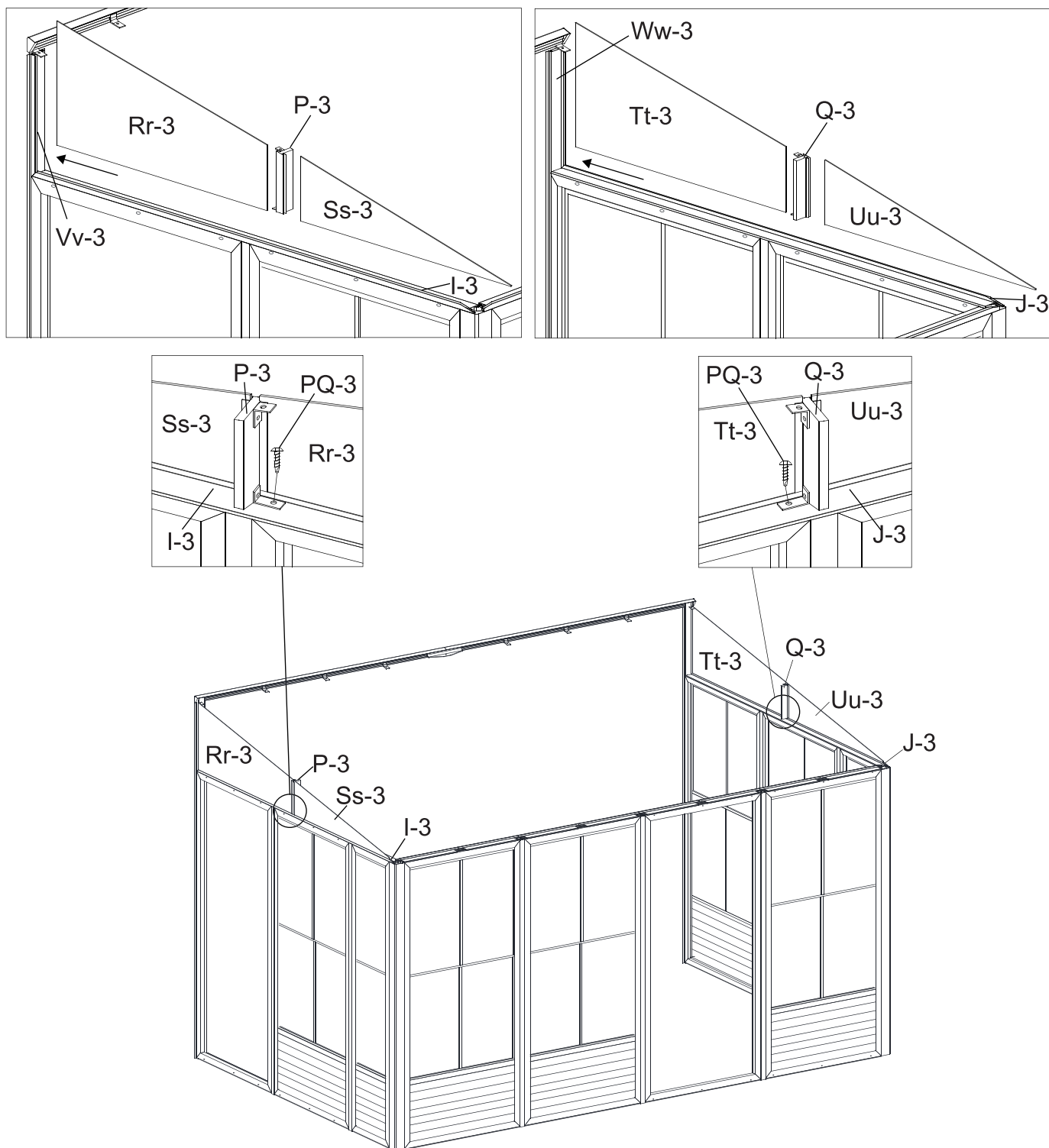

8. Placer le polycarbonate côté exposé à l'extérieur sur le récepteur latéral gauche (I-3), utiliser un panneau pignon arrière gauche (Rr-3), un joint pignon gauche (P-3) et un panneau pignon avant gauche (Ss-3), puis faire le côté droit avec un panneau pignon arrière droit (Tt-3), un joint pignon droit (Q-3) et un panneau pignon avant droit (Uu-3) sur le récepteur latéral droit (J-3) du panneau horizontal. Fixer les joints de pignon (P-3) et (Q-3) au récepteur latéral (I-3) et (J-3), respectivement, à l'aide de vis (PQ-3).

## Étape 9

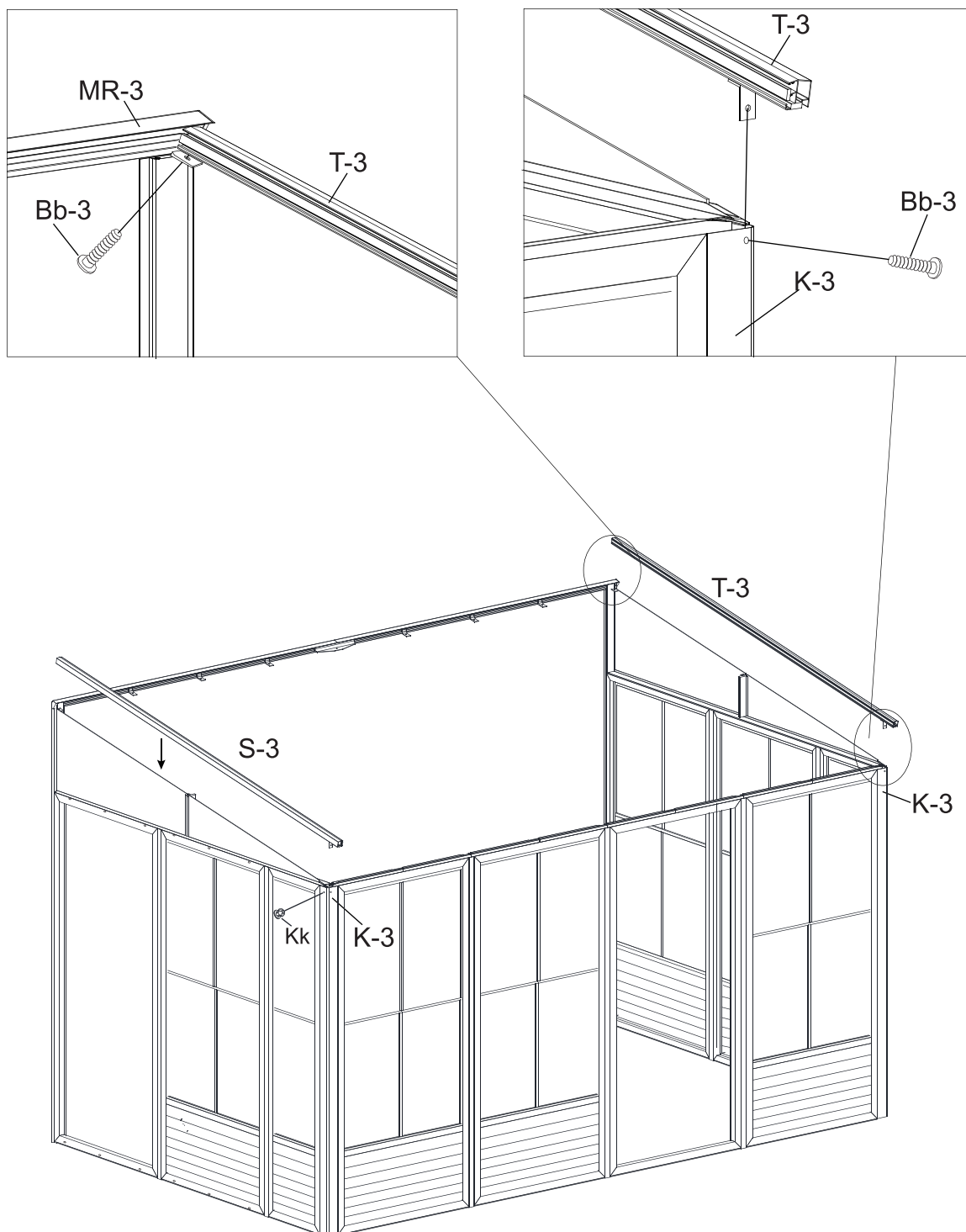

9. Placez le chevron latéral droit (T-3) sur le dernier support, puis fixez-le au connecteur d'angle (K-3) et au support de joint de pignon droit (Q-3) à l'aide de la vis (Bb-3). Répétez sur le côté gauche avec le chevron latéral gauche (S-3).

## Étape 10

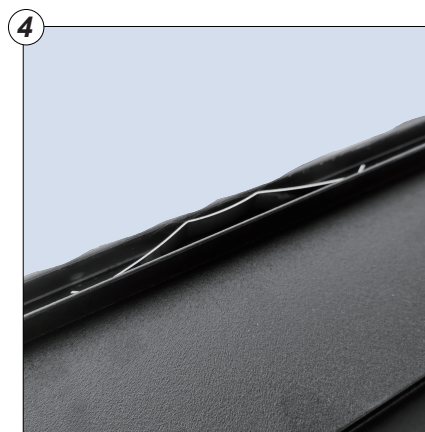
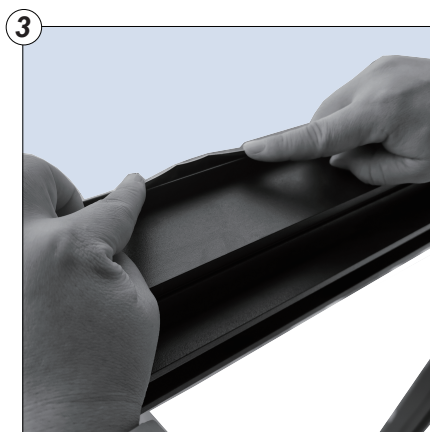
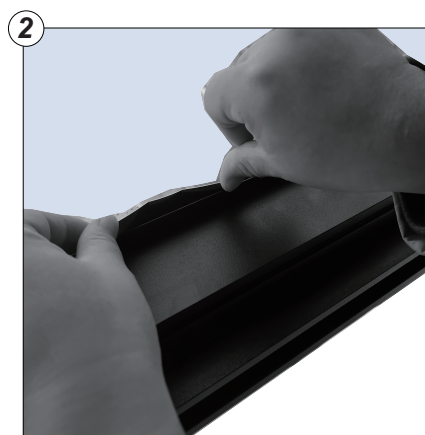
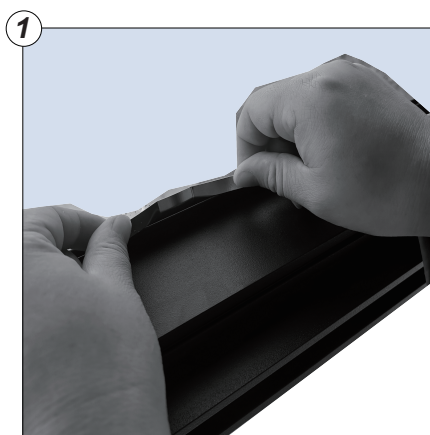
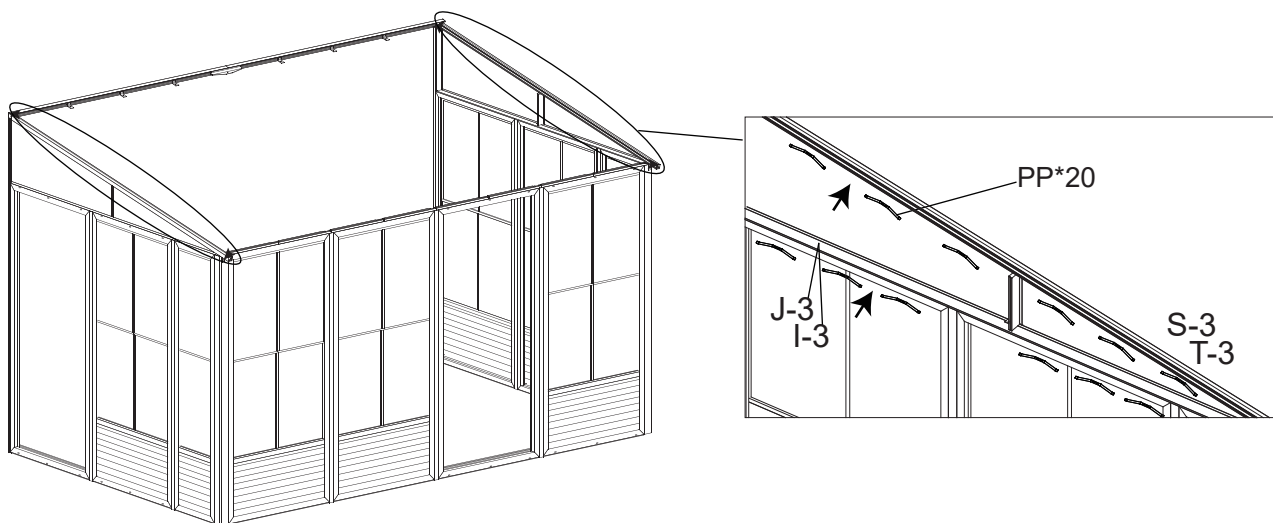

10. Installer la lame à ressort (PP) dans la rainure interne des Chevrons (T-3/S-3) et du receptrer lateral (I-3/J-3). Elle sert a maintenir le panneau en place.

## Étape 11

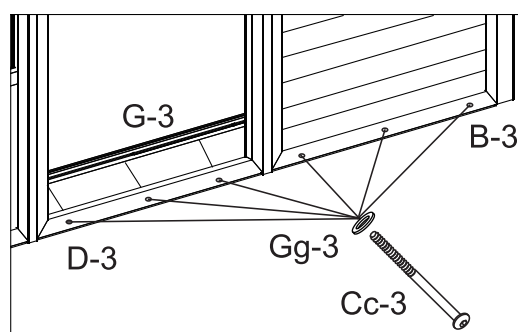
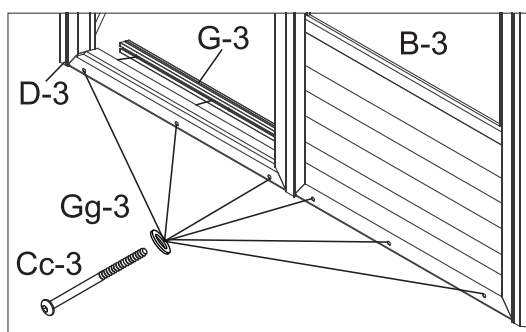
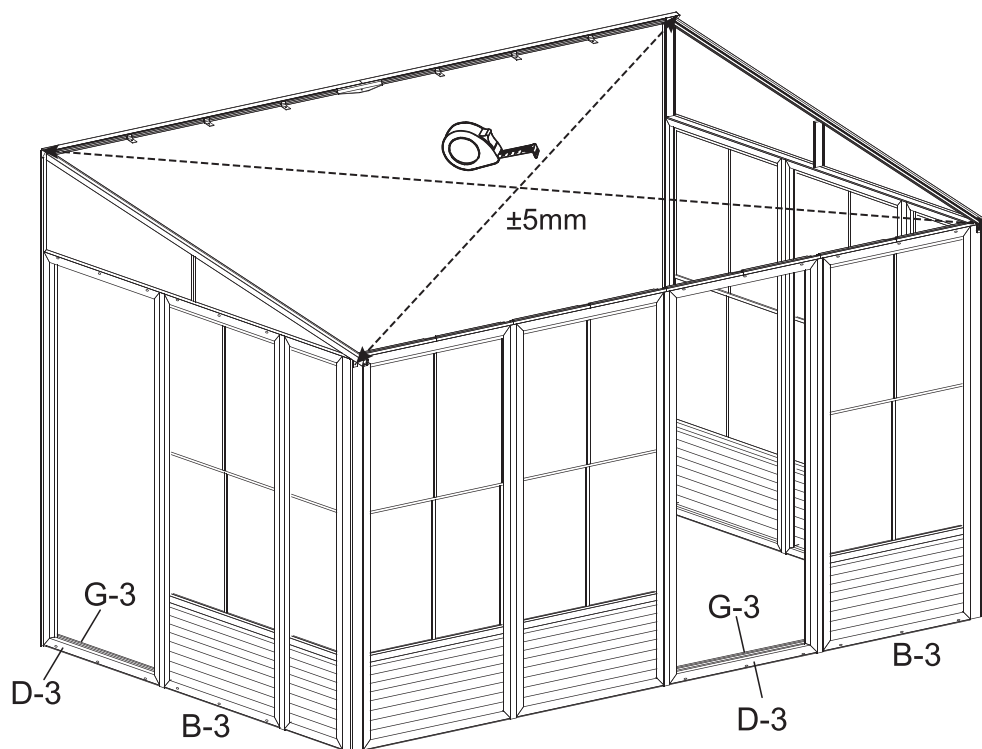

11 . Fixez le cadre de la porte coulissante (D-3), le cadre à côté de la porte (B-3) et le rail de la porte inférieure (G-3) à l'aide de boulons (Cc-3) et de rondelles (Gg-3).

**REMARQUE :** Assurez-vous que les mesures prises en diagonale sur l'ensemble du cadre se situent à 5 mm près à la même distance après avoir effectué cette étape.

## Étape 12

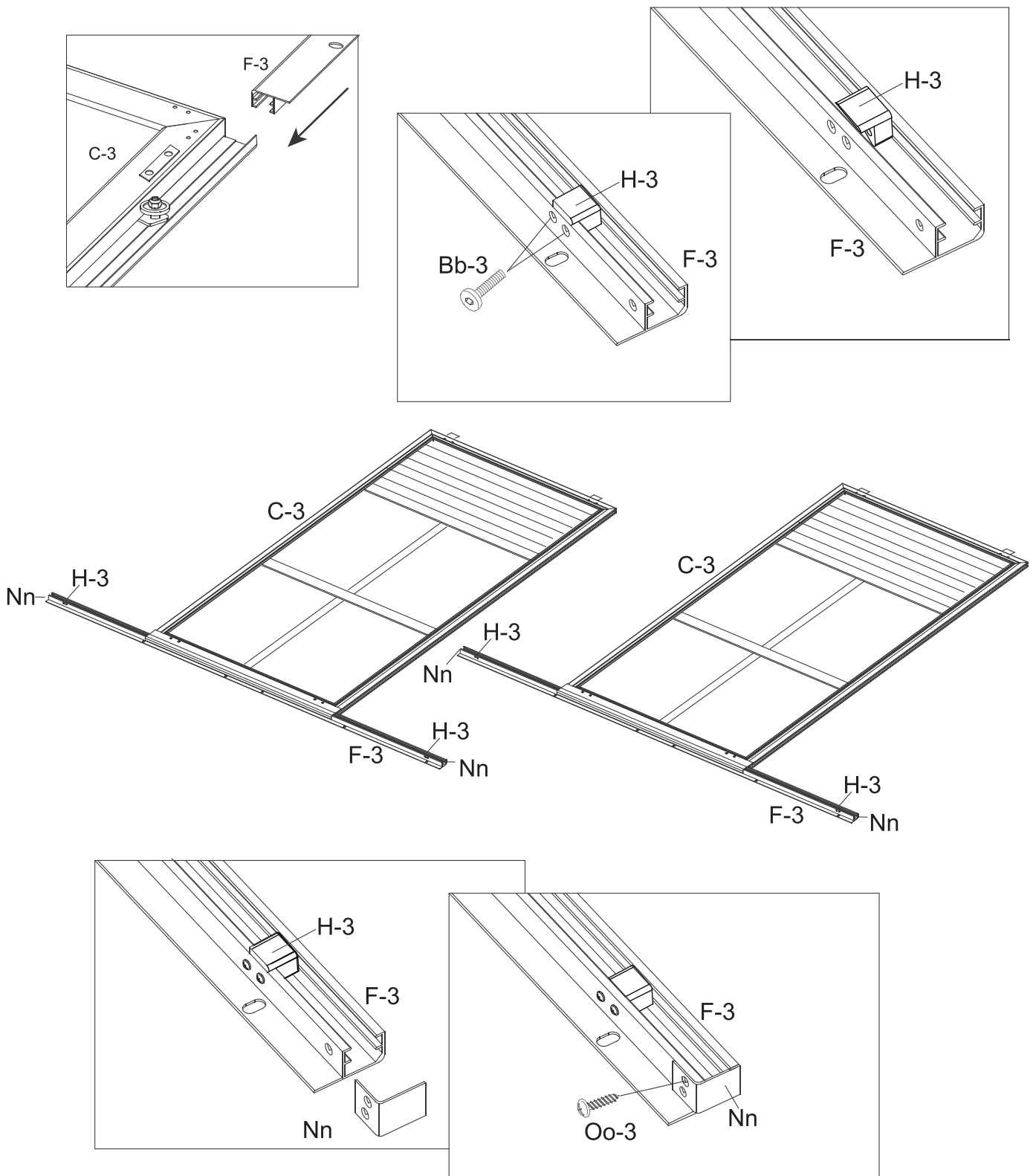

12.1 Insérer le rail supérieur de la porte (F-3) dans la pièce de liaison située en haut de la porte coulissante (C-3).

12.2 Fixez le bouchon en plastique (H-3) aux deux extrémités du rail supérieur de la porte (F-3) à l'aide des boulons (Bb-3).

12.3 Fixez l'extrémité du rail supérieur de la porte (Nn) sur les deux extrémités du rail supérieur de la porte (F-3) à l'aide des boulons (Oo-3).

## Étape 13

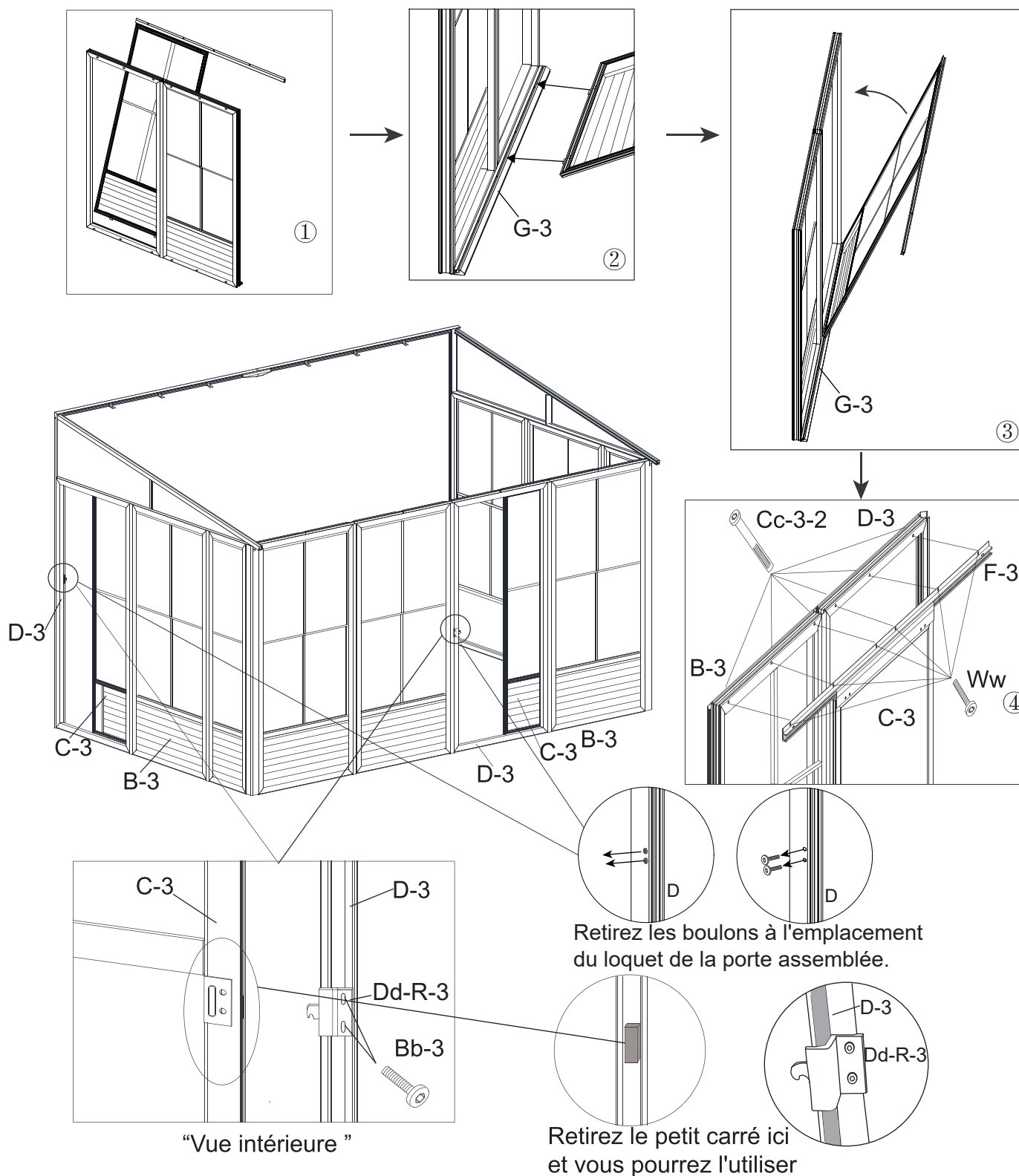

13.1 Placez la porte coulissante assemblée (C-3) à la verticale, insérez l'extrémité inférieure dans le rail de la porte inférieure (G-3) et fixez l'extrémité supérieure avec les boulons (Cc-3 — 2/Ww). Veillez à pousser vers le haut le rail de la porte supérieure (F-3) afin que les portes ne frottent pas contre le rail inférieur.

13.2 Fixez le loquet de la porte droite (Dd-R-3) et (Dd-L-3) au cadre de la porte coulissante à l'aide des boulons (Bb-3).

## Étape 14

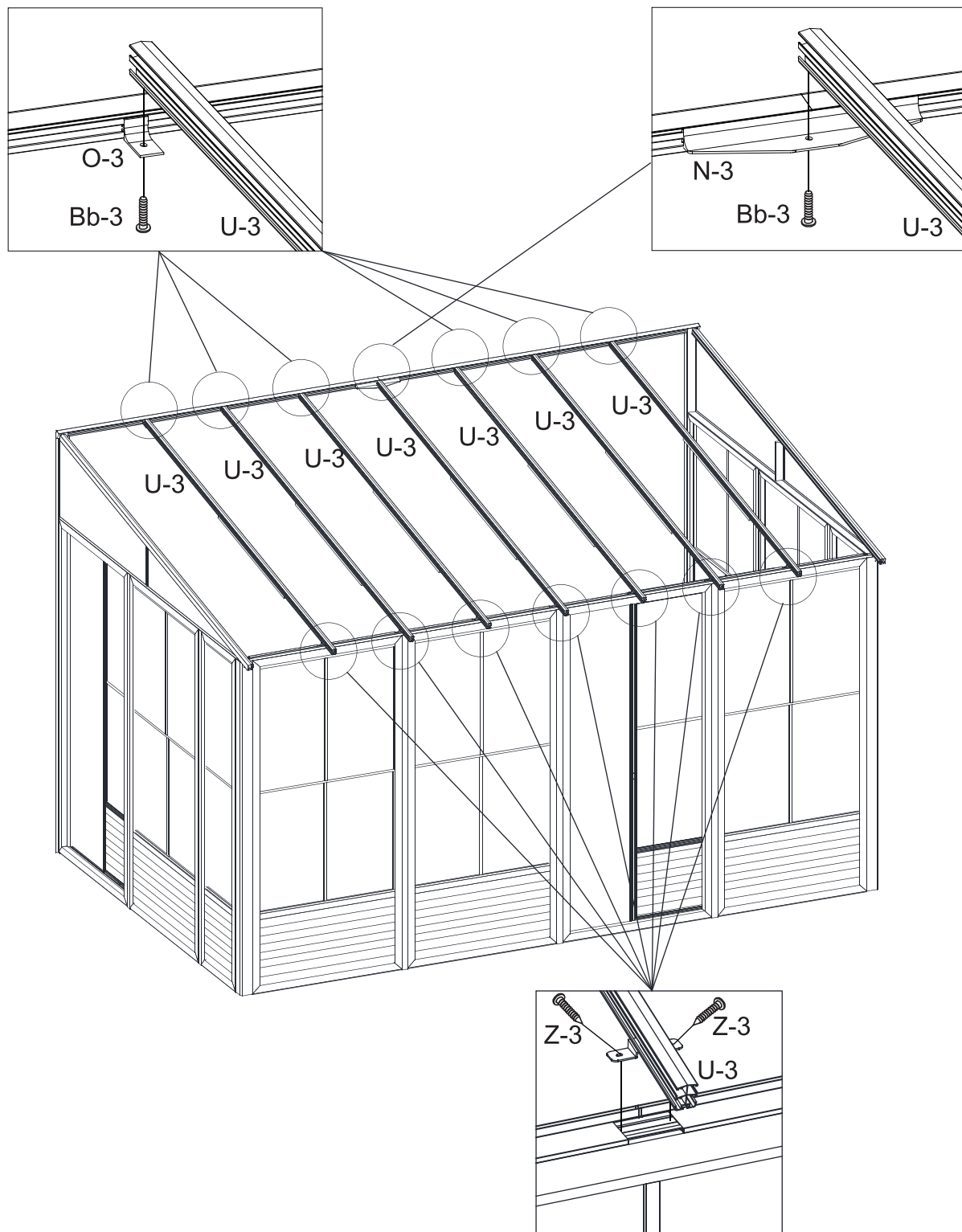

14. Fixer les chevrons (U-3) au milieu de chaque panneau avec des vis Bb-3 en haut et deux vis (Z-3) sur les supports d'ossature à la main. Placer les chevrons (U-3) sur chaque joint et utiliser les vis (Z-3) à la main. Ne pas utiliser de perceuse électrique.

## Étape 15

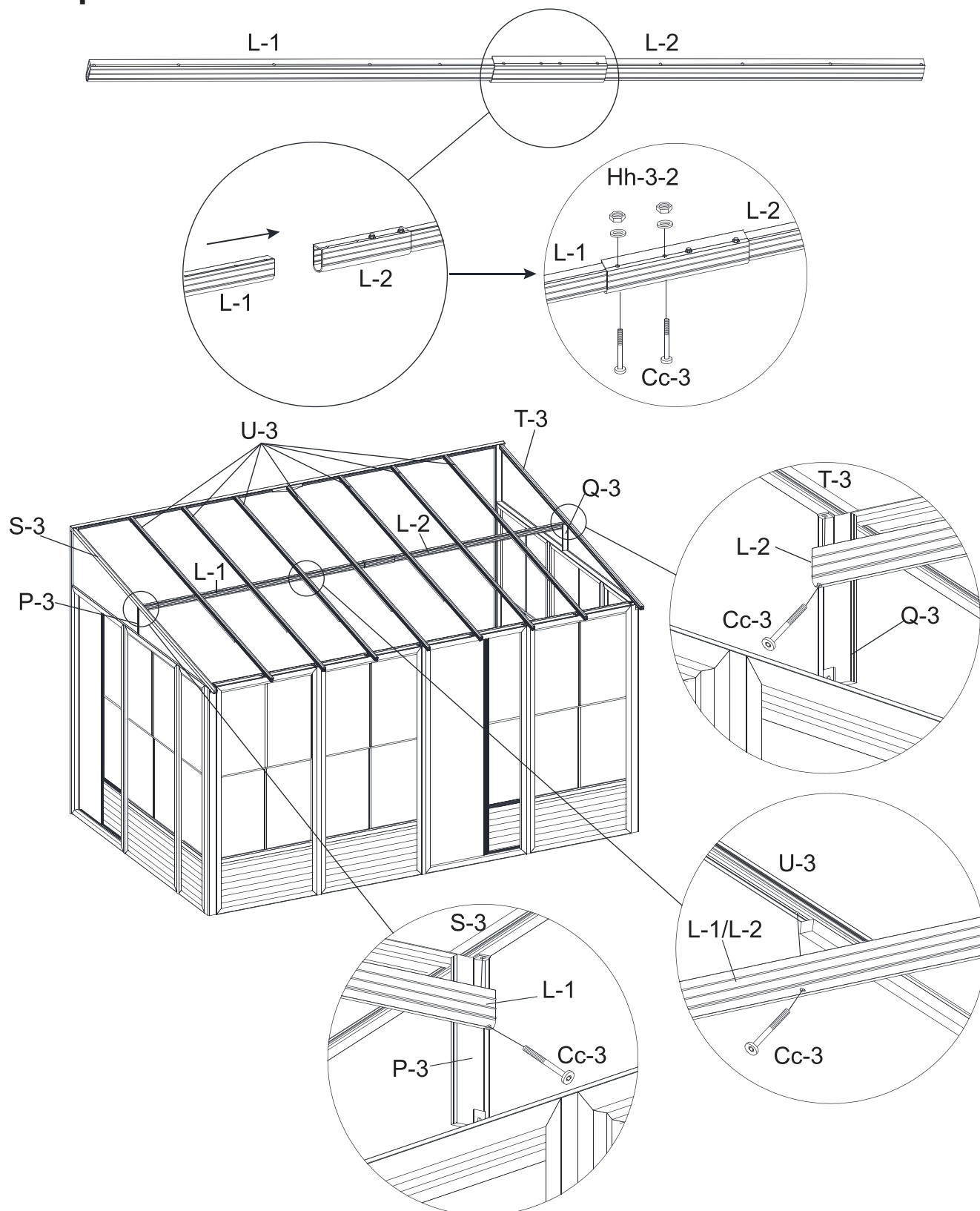

- 15.1. Assembler les traverses L-1 et L-2 à l'aide du boulon (Cc-3) et de l'écrou (Hh-3-2).
- 15.2. Fixez la traverse (L-1) et la traverse (L-2) assemblées au chevron latéral gauche (S-3) et au chevron latéral droit (T-3) à travers le joint de pignon (P-3) et le joint de pignon (Q-3), connectez le milieu au chevron régulier (U-3) et fixez-les avec des boulons (Cc-3). Serrez les boulons manuellement.

## Étape 16

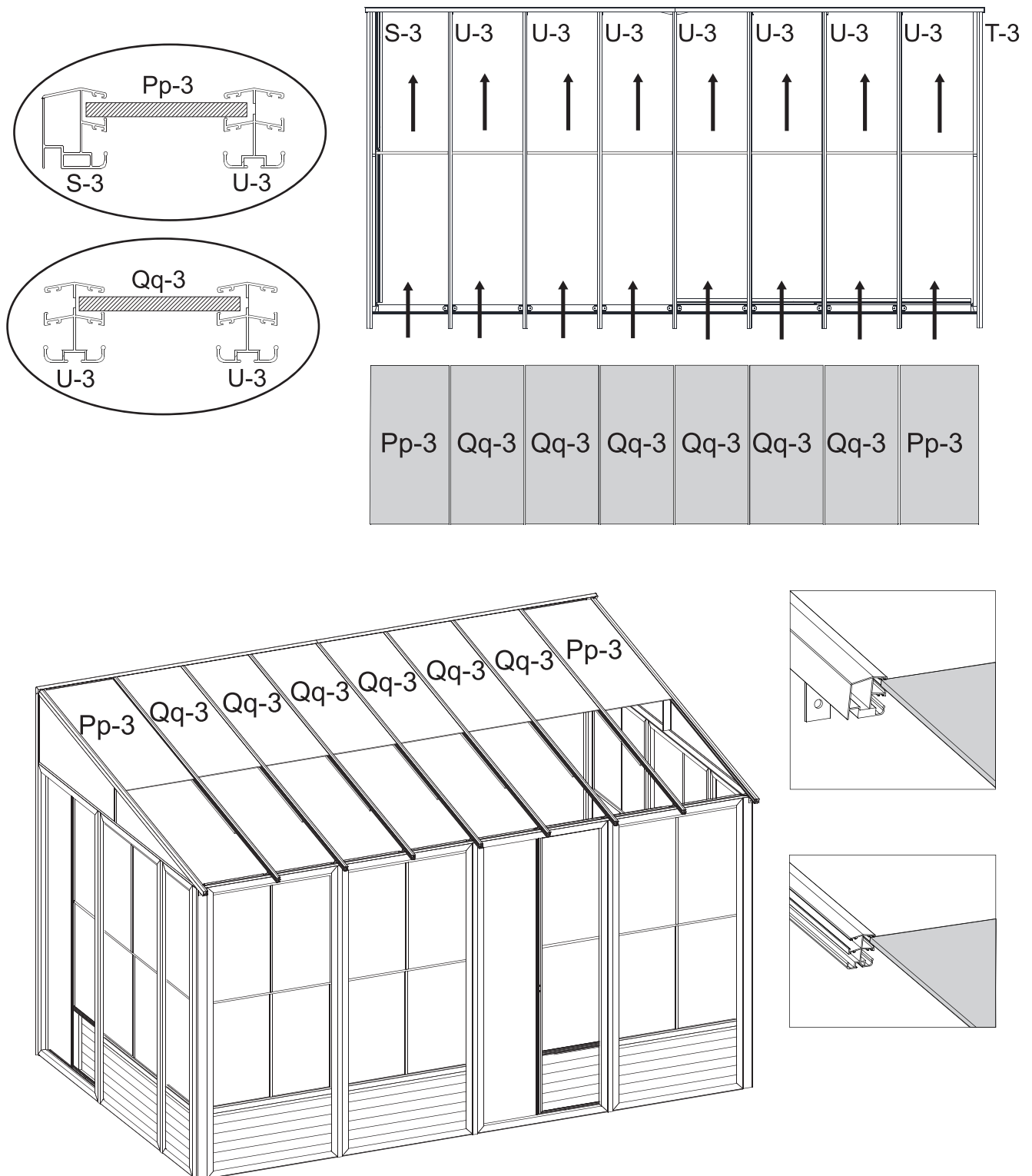

16. Retirez le film protecteur des deux côtés de chaque panneau, en veillant à ce que la face supérieure du panneau soit orientée vers la lumière du soleil. Insérez et faites glisser le panneau sur la rainure supérieure des chevrons jusqu'à l'extrémité. Le panneau de toit (Pp-3) doit être placé en premier et en dernier, avec le panneau de toit (Qq-3) entre les deux.  
Remarque : le côté avec la couche de protection doit être orienté vers le bas, et le côté avec la protection contre les UV doit être orienté vers le haut.

## Étape 17

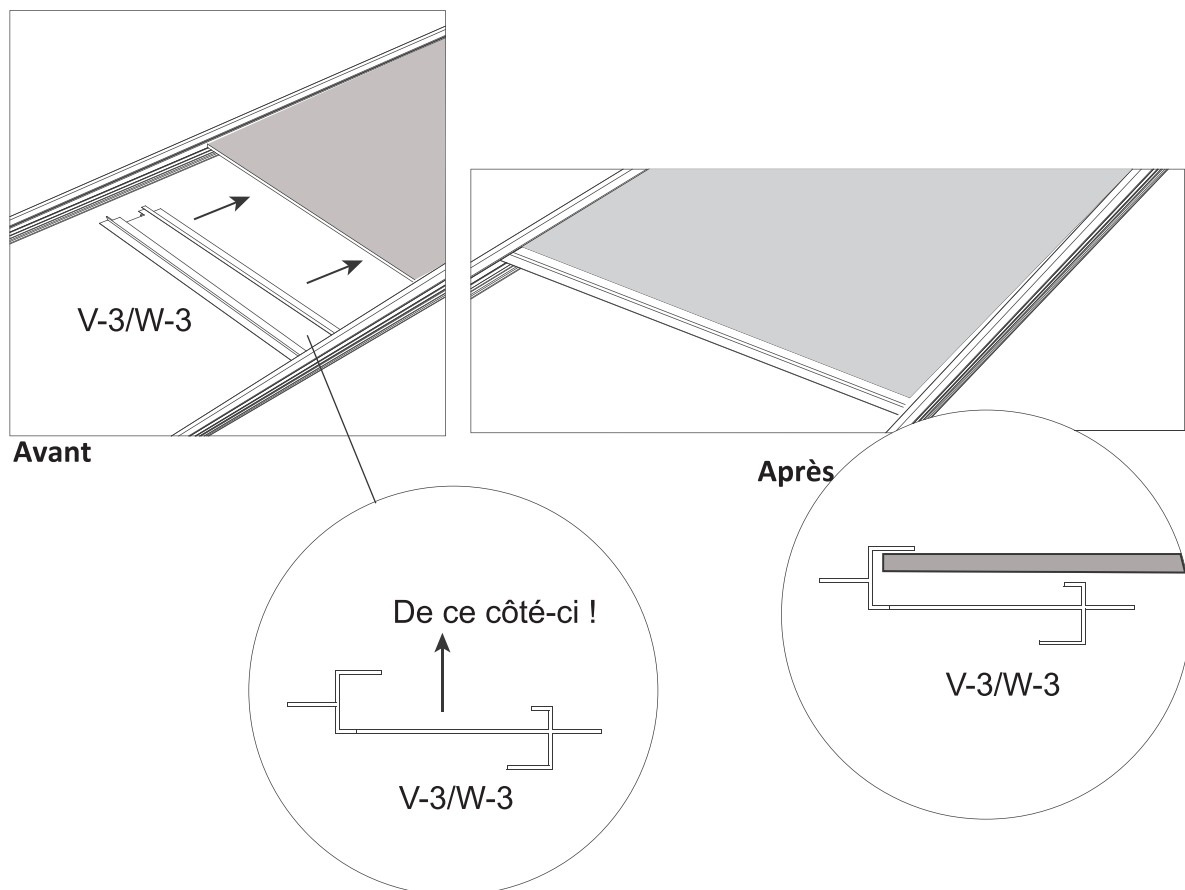
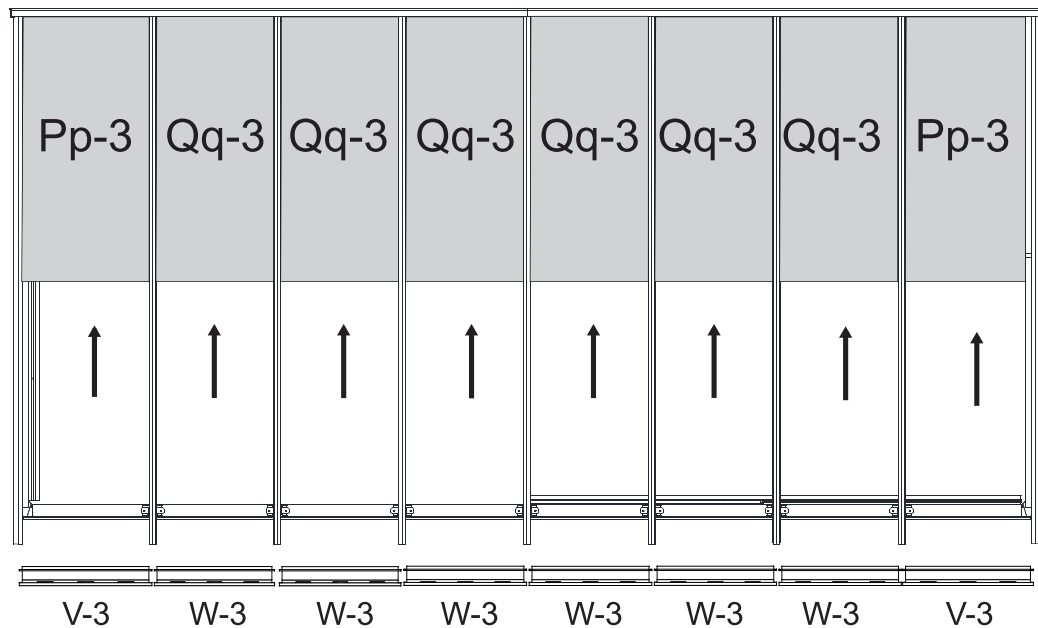

17. Insérez le joint de toiture central en aluminium entre les chevrons, en veillant à ce que les trous oblongs soient en bas. Faites-le glisser dans les rainures supérieures et inférieures des chevrons, puis faites-le glisser jusqu'au bout dans les panneaux. Assurez-vous que les panneaux se trouvent à l'intérieur de la rainure du joint de toiture central en aluminium. Insérez un (V-3) à chaque extrémité, puis tous les (W-3) et enfin les (V-3) restants. Tapez doucement avec un maillet en caoutchouc si nécessaire.

# Étape 18

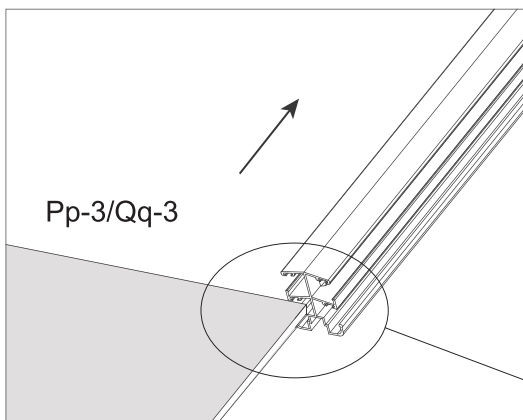
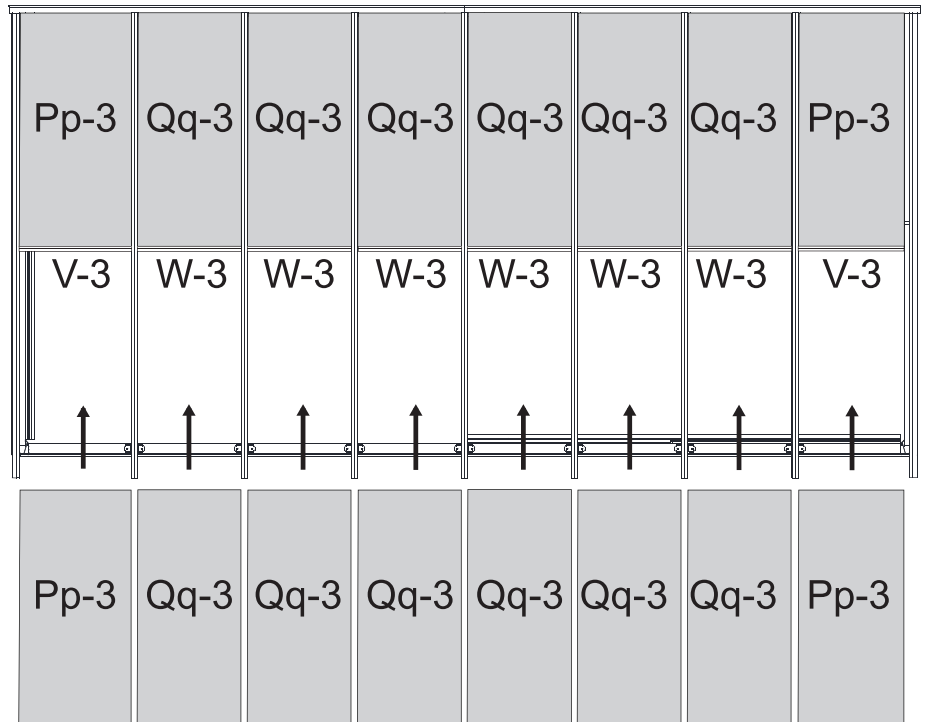
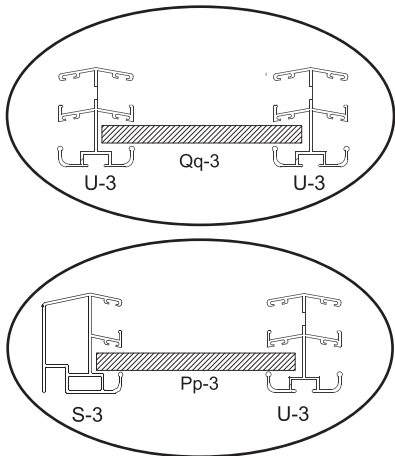

Remarque: "Assurez - vous d'avoir Protection UV face vers le Haut."

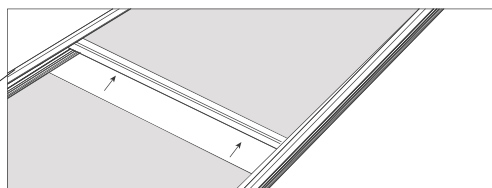

Avant

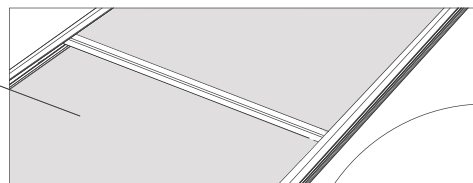

Après

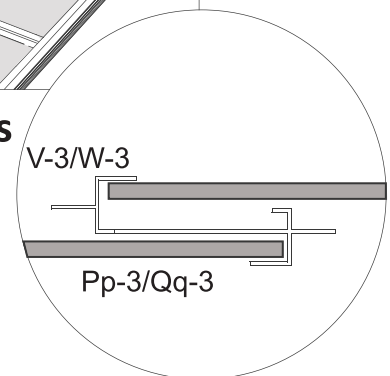

18. Insérez la deuxième rangée de panneaux dans la rainure inférieure du chevron. Faites glisser les panneaux jusqu'à ce qu'ils atteignent les pièces d'aluminium entre les panneaux, et tapez doucement sur le panneau pour le guider dans la rainure d'aluminium. Utilisez une spatule pour l'ajuster si nécessaire. Insérez deux (Pp-3) à chaque extrémité, puis insérez les panneaux (Qq-3).

## Étape 19

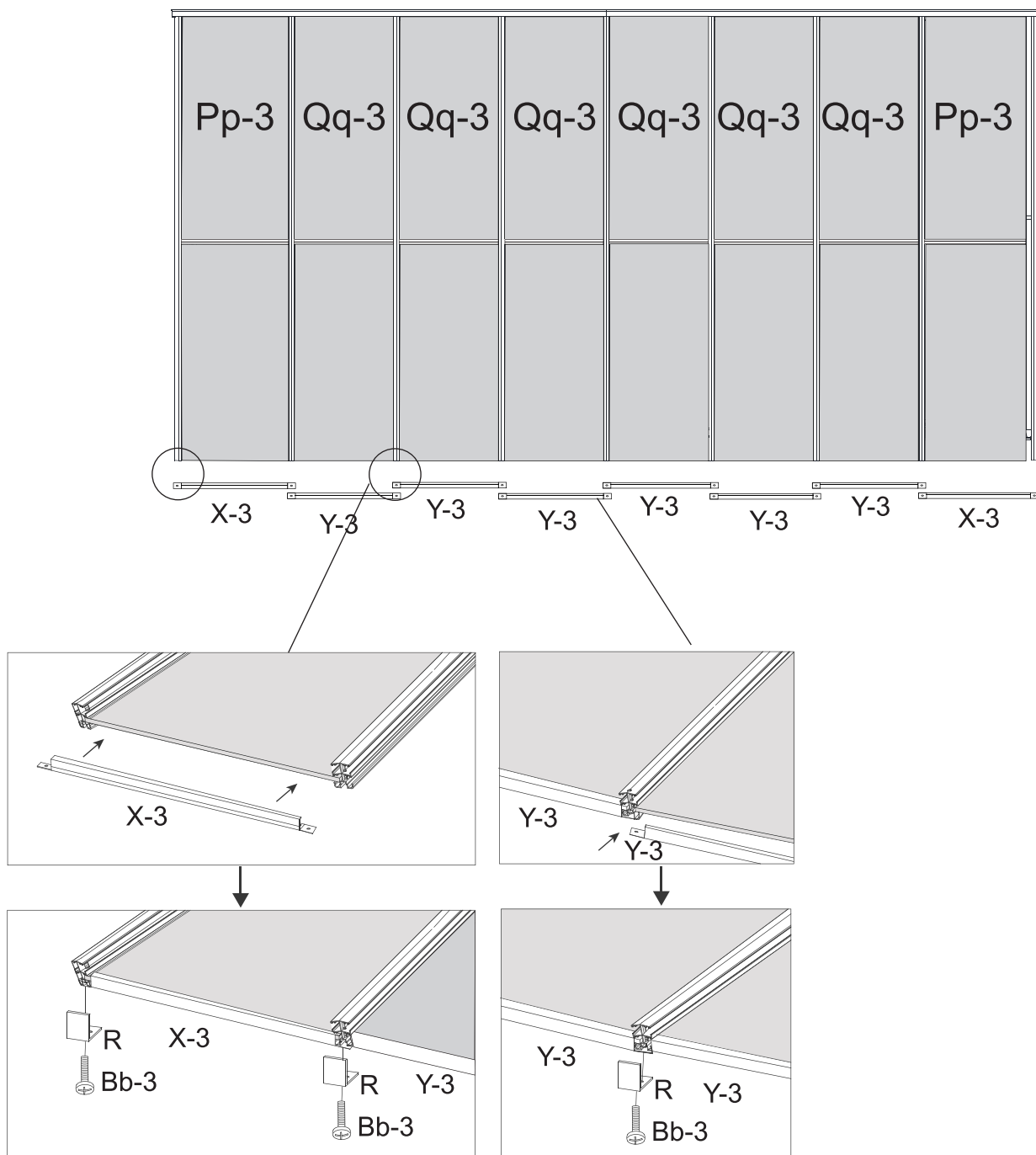

19. En commençant par une extrémité, ajoutez le bord (X-3) et un support (R-3) et vissez avec (Bb-3) à la main, n'utilisez pas de perceuse électrique. Ajoutez le bord (Y-3) et répétez jusqu'à la fin, puis ajoutez le bord (X-3).

## Étape 20

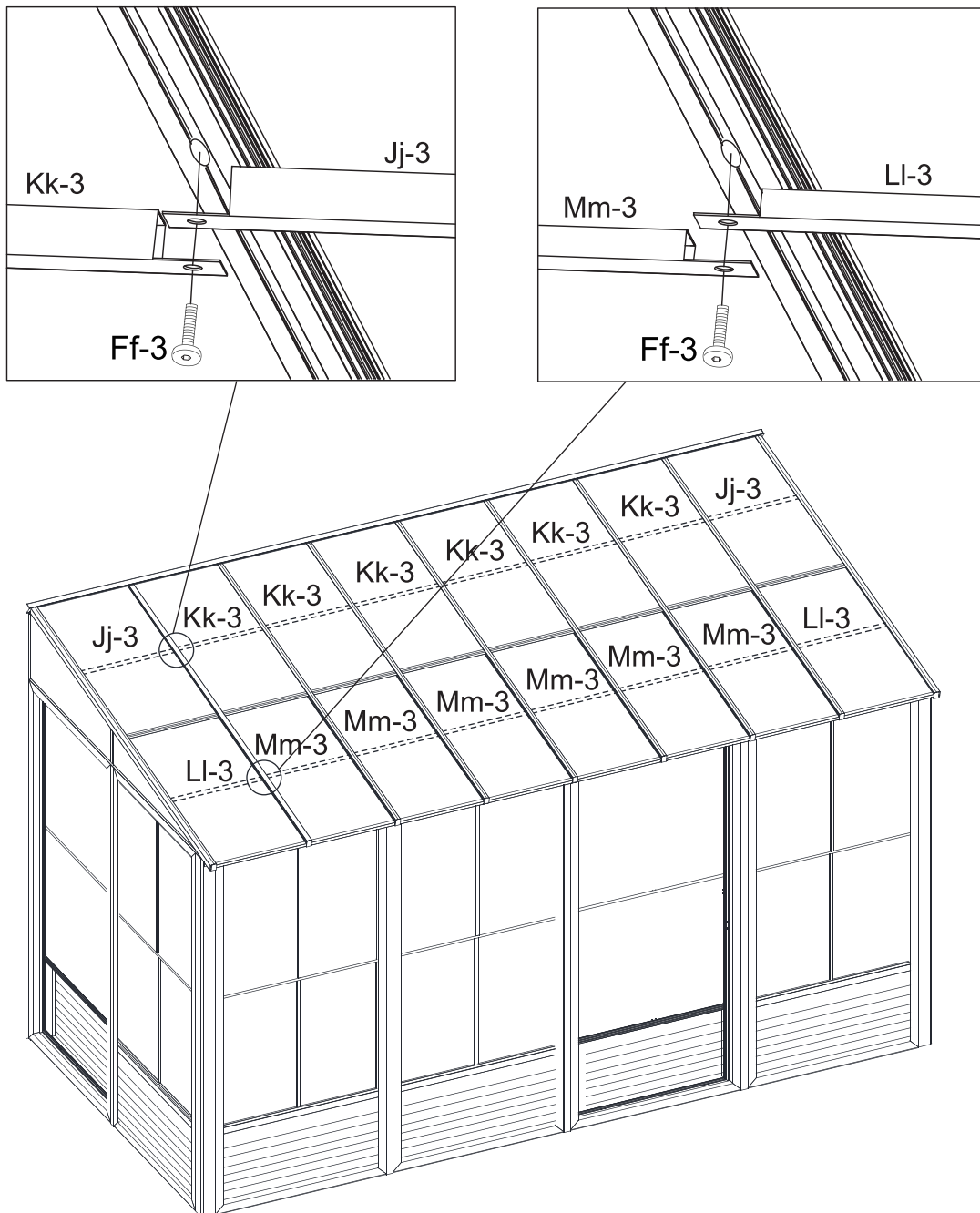

20. À l'intérieur du solarium, sous chaque chevron, il y a deux rangées d'insertions filetées. Commencez la rangée supérieure avec une (Jj-3) à chaque extrémité et vissez-la avec (Ff-3) et entre les panneaux (Kk-3). Utiliser les vis (Ff-3) pour la rangée inférieure (LI-3) aux 2 extrémités, puis les autres entre les panneaux (Mm-3). Veiller à ce que les vis soient serrées à la main.

## **NOTES SPÉCIALES**

Pour retirer un écran, enlevez deux (2) vis de la partie supérieure du cadre et tirez vers les côtés vers les extrémités des poignées pour l'enlever. Pour retirer les panneaux contre le vent, poussez ou déplacez-les de côté et assurez-vous que la goupille n'est pas verrouillée. Retirez les panneaux doucement car ils sont faciles à enlever.

### **REMARQUE:**

Ce solarium n'est pas imperméable à l'eau. Pour la meilleure protection contre la pluie, fermez les fenêtres de chaque panneau avec la fenêtre extérieure au milieu, et celle d'intérieur en haut.

### **DIRECTIVES DE NETTOYAGE:**

Utilisez seulement de l'eau savonneuse tiède et non des produits de nettoyage puissants ou d'abrasifs. Assurez-vous de retirer l'accumulation de neige et/ou la glace.

### **AVERTISSEMENT:**

- 1) N'utilisez pas le BBQ ou tout autre produit inflammable à l'intérieur du solarium.
- 2) **Enlevez la neige de la toit.**

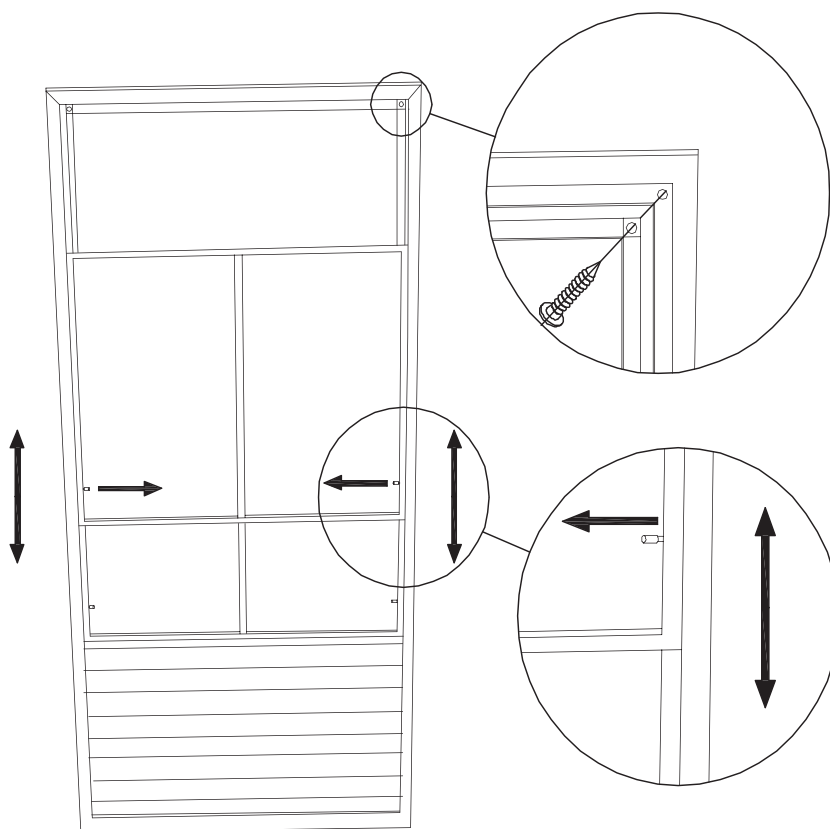

### **\*Suggestions**

Les éléments mentionnés ci-dessous ne sont que des suggestions afin de permettre le drainage, elles varieront en fonction de votre revêtement de sol - matériel, platitude et pente.

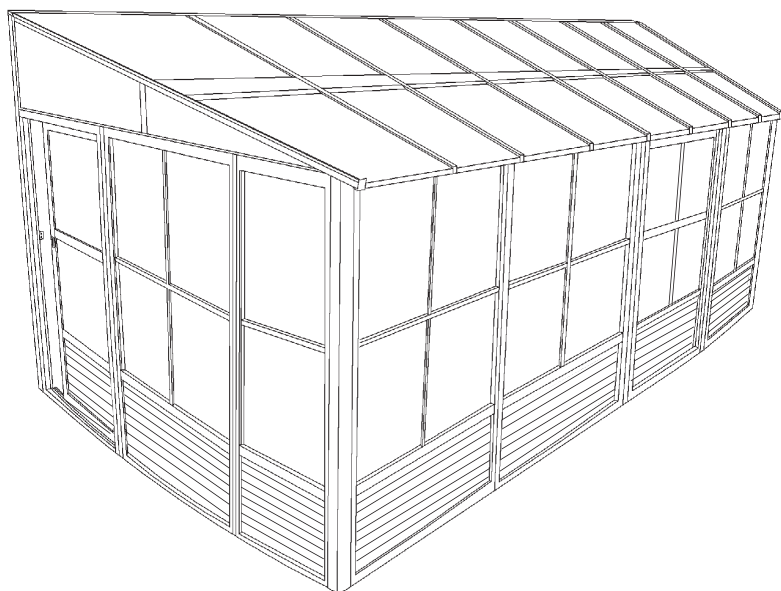

### **POUR SOL EN BÉTON**

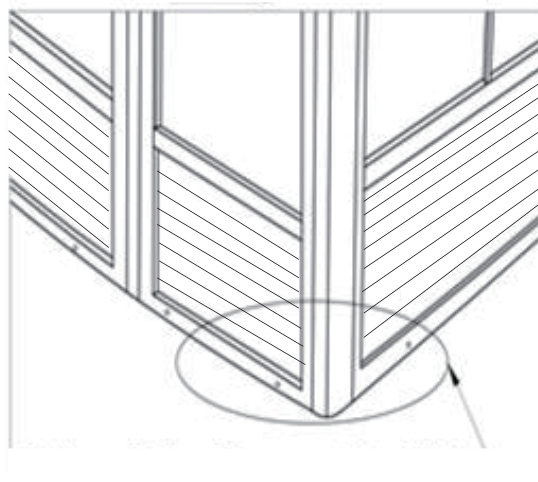

Sur la face extérieure, il est suggéré de percer des trous à l'extrémité inférieure des panneaux pour permettre le drainage.

### **Pour Deck en bois:**

Forez les ponts où se trouvent les trous de drainage pour permettre de l'eau passer à travers.

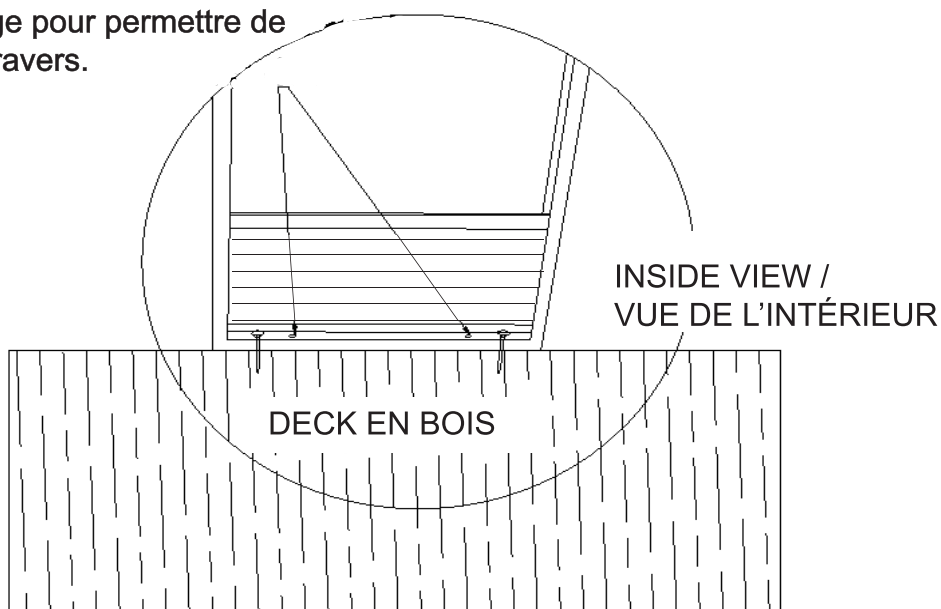

# GARANTIE

Inspectez soigneusement le contenu de l'emballage afin de vérifier si certaines composantes sont manquantes ou endommagées. Advenant que certaines pièces soient manquantes ou endommagées, **ne retournez pas le produit à l'endroit où vous l'avez acheté**; contactez plutôt le département d'expérience client de Gazebo Penguin

Montréal : (514) 276-3485

Ailleurs au Canada et États-Unis : 1-800-737-7174

info@gazebopenguin.com

Ce produit a été conçu et fabriqué afin de répondre aux normes les plus exigeantes en matière de qualité et de durabilité.

Sous réserve de la section « limitations et exclusions à la garantie » ci-dessous, il est garanti contre les défauts matériels ou de fabrication:

- **1 AN SUR LES DÉFAUTS MANUFACTURIERS**

Advenant que le produit soit endommagé ou que la période de garantie soit expirée, veuillez contacter le département d'expérience client de Gazebo Penguin afin d'obtenir une liste complète des pièces de remplacement et des prix.

## LIMITATIONS ET EXCLUSIONS À LA GARANTIE

- 1. Dommages non couverts:** Cette garantie ne couvre pas les dommages causés par le vent, la chute d'objets, le feu, les animaux, la végétation, le vandalisme, les conditions climatiques extrêmes, ni les effondrements dus à l'accumulation de neige et de glace.
- 2. Entretien du toit:** Le toit doit rester libre de toute accumulation de neige ou de glace. Ces accumulations doivent être retirées en sections de cinq pieds (5) à la fois, de droite à gauche. Les dommages causés par un défaut d'entretien du toit ne sont pas couverts par la garantie.
- 3. Retrait de neige et de glace:** Le retrait de neige ou de glace depuis l'intérieur du produit est interdit, car il peut causer des dommages au produit.
- 4. Positionnement:** Il est déconseillé de placer le produit à proximité d'immeubles ou d'arbres, car la neige ou la glace peut glisser et s'accumuler sur le toit, provoquant un poids excessif.
- 5. Installation:** La garantie est valide uniquement si le produit est installé conformément aux instructions fournies par Gazebo Penguin. Une installation incorrecte, notamment un ancrage inadéquat, annule la garantie.
- 6. Infiltration d'eau:** Des infiltrations d'eau peuvent survenir en cas de fortes pluies. Consultez le manuel d'instructions pour les positions des fenêtres et les informations sur l'évacuation de l'eau.
- 7. Clause de remplacement:** Nous nous réservons le droit de réparer ou remplacer tout produit ou pièce défectueuse, à notre seule discrétion.
- 8. Modifications:** Toute modification ou ajout au produit annule la garantie.



# MANUEL D'INSTRUCTIONS INSTRUCTION MANUAL

---

**Florence Solarium 10 PI. X 16 PI.**  
**Florence Solarium 10 FT. X 16 FT.**

sku: W1610-GP-12		
sku: W1610-GP-32		
sku: W1610-GP-42		

**DO NOT DESTROY THE BOXES UNTIL COMPLETELY ASSEMBLED  
FOR FUTURE REFERENCE,  
TAKE PICTURES OF ALL SIX SIDES OF EACH OF THE BOXES UPON RECEIPT.  
PLEASE VERIFY THE CONTENT OF EACH BOX AGAINST THE LIST OF PARTS**  
**10ft x 16ft / 3.04m x 4.87m Solarium  
Instruction Manual**

Consult with your local governing authority / local municipal codes regarding installation of temporary structures before purchase or assembly. Some jurisdictions may require permits for, or otherwise regulate, installation and use.

**IMPORTANT: RETAIN FOR FUTURE REFERENCE, READ CAREFULLY**

For assistance with assembly, installation, parts, or customer service, contact Gazebo Penguin Customer Service Department at the numbers listed below (English & French, Mon-Fri 8:00 AM to 4:00 PM EST):

**Montreal:** (514) 276-3485

**Elsewhere in Canada and the US:** 1-800-737-7174

**WARNING:**

- For outdoor use.
- Snow should be regularly cleared from the roof and not allowed to accumulate.
- Retain your **proof of purchase** for warranty purposes. Also keep the **original boxes** until the installation is complete and correct.
- The unit may take more than 4 hours and 3 people are required for this assembly.



**PRIOR TO ASSEMBLY:**

- Please don't destroy boxes until completely assembled.
- The foundation must be level, flat, and solid, such as concrete or asphalt.
- Keep away from overhead utility lines, tree branches, and other structures.
- Check for underground pipes or wires if digging or drilling is required.
- Do not install near roof lines or other structures that could shed snow, ice, or excessive rain run-off onto the roof top.
- Assemble the structure as close to its final location as possible.
- It is recommended to wear safety gloves, safety glasses, and hard hats for installation.
- Do not hang from, climb on, or stand on the structure or roof.
- Before assembly, read instructions and check that all parts are present in the boxes. If any parts are missing, refer to warranty information.
- A 6ft (1.8m) stepladder, Phillips screwdriver, tape measure, level, mallet, and a tarp to place parts on will be required for assembly (not included).
- Remove top protective film from roof panels prior to assembly; DO NOT remove bottom protective film until ready to insert roof panels, so as to identify which side is on top.

**ANCHORING INSTRUCTIONS:**

- Proper anchoring of the frame to the base and the wall is required for safety.
- Any structure not anchored securely has the potential to fly away during high wind causing damage and safety hazard.
- How the item is anchored, and the hardware and tools required, will vary based upon the set up location and are not provided.
- Please check with your local hardware store if for the appropriate anchors for your surface.
- Do not anchor to pavers / pavement slabs because they are not a solid foundation.
- Periodically check the anchors to ensure they remain secure

**CARE AND MAINTENANCE:**

- In case of a defective or damaged part, or for any other questions concerning the product, please contact the manufacturer directly.
- Please have the parts list and part numbers on hand when ordering or requesting replacement parts.











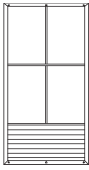

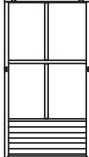
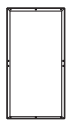

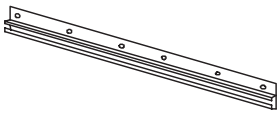
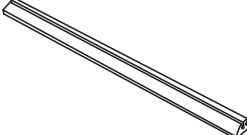









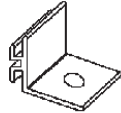
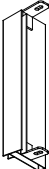

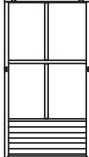
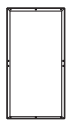

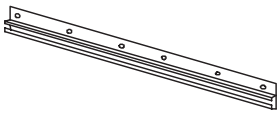
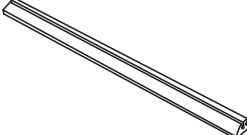









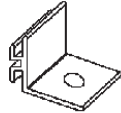
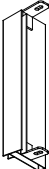

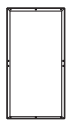

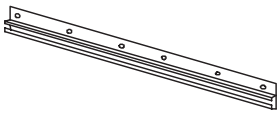
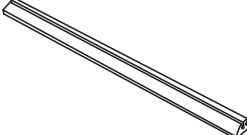









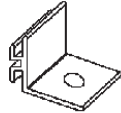
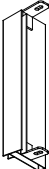

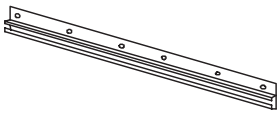
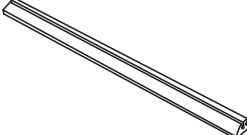

**ROOF PANELS:**







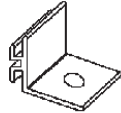
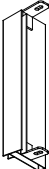







- Gently clean with an environmentally-friendly soap solution and water using a sponge or washcloth.
- Do not use abrasive materials, wire brushes, chemicals, harsh cleaners, or bleach.
- Rinse using a garden hose and air dry. If removed, ensure thoroughly dry prior to storage.
- Do not use pressure washer.



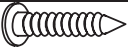

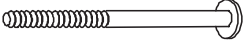
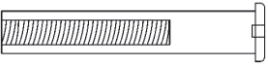
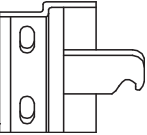
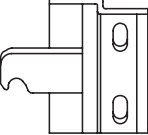



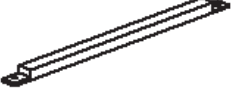



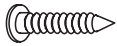

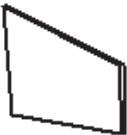

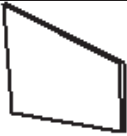
**STRUCTURE:**

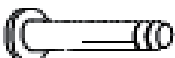
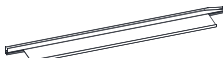
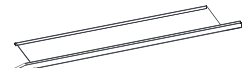

- Gently clean with an environmentally-friendly soap solution and water using a sponge or washcloth.
- Do not use abrasive materials, wire brushes, chemicals, harsh cleaners, or bleach.
- Rinse using a garden hose and air dry.
- Do not use pressure washer.
- If there are nicks, chips, and/or scratches see the part # of the paint in the parts list to obtain a matching touch-up paint.

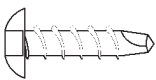









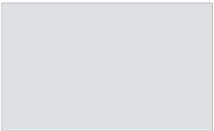
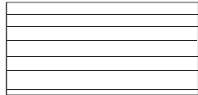

### SOLARIUM W1610 ½

DESCRIPTION	PACKED IN BOX	QTY	DRAWING	DESCRIPTION	PACKED IN BOX	QTY	DRAWING																																																																										
23-093 REGULAR FRAME A-3	2	2		23-094 FRAME NEXT TO DOOR B-3 (with extra holes)	2	1																																																																											
	3	2			3	1		23-099 HALF FRAME A-3 1/2	2	1		23-095 SLIDING DOOR C-3	2	1		3	1	3	1	10-499 SLIDING DOOR FRAME D-3	2	1		11-544 CONNECTING PIECE E-3	4	14		3	1	11-545 TOP DOOR RAIL F-3	4	2		11-546 BOTTOM DOOR RAIL G-3	4	2		08-138 PLASTIC STOPPER H-3	5	4		12-142 LEFT SIDE RECEIVER I-3	4	1		12-143 RIGHT SIDE RECEIVER J-3	4	1		10-502 CORNER CONNECTOR K-3	4	2		12-157 LEFT CROSSBEAM L-1	4	1		12-156 RIGHT CROSSBEAM L-2	4	1		10-532 TRACK ML-3	4	1		10-533 TRACK MR-3	4	1		10-505 TRACK JOINT N-3	5	1		10-506 RAFTER BRACKET O-3	5	6		12-007 LEFT GABLE JOINT P-3	5	1	
23-099 HALF FRAME A-3 1/2	2	1		23-095 SLIDING DOOR C-3	2	1																																																																											
	3	1			3	1		10-499 SLIDING DOOR FRAME D-3	2	1		11-544 CONNECTING PIECE E-3	4	14		3	1	11-545 TOP DOOR RAIL F-3	4	2		11-546 BOTTOM DOOR RAIL G-3	4	2		08-138 PLASTIC STOPPER H-3	5	4		12-142 LEFT SIDE RECEIVER I-3	4	1		12-143 RIGHT SIDE RECEIVER J-3	4	1		10-502 CORNER CONNECTOR K-3	4	2		12-157 LEFT CROSSBEAM L-1	4	1		12-156 RIGHT CROSSBEAM L-2	4	1		10-532 TRACK ML-3	4	1		10-533 TRACK MR-3	4	1		10-505 TRACK JOINT N-3	5	1		10-506 RAFTER BRACKET O-3	5	6		12-007 LEFT GABLE JOINT P-3	5	1		12-008 RIGHT GABLE JOINT Q-3	5	1									
10-499 SLIDING DOOR FRAME D-3	2	1		11-544 CONNECTING PIECE E-3	4	14																																																																											
	3	1						11-545 TOP DOOR RAIL F-3	4	2		11-546 BOTTOM DOOR RAIL G-3	4	2		08-138 PLASTIC STOPPER H-3	5	4		12-142 LEFT SIDE RECEIVER I-3	4	1		12-143 RIGHT SIDE RECEIVER J-3	4	1		10-502 CORNER CONNECTOR K-3	4	2		12-157 LEFT CROSSBEAM L-1	4	1		12-156 RIGHT CROSSBEAM L-2	4	1		10-532 TRACK ML-3	4	1		10-533 TRACK MR-3	4	1		10-505 TRACK JOINT N-3	5	1		10-506 RAFTER BRACKET O-3	5	6		12-007 LEFT GABLE JOINT P-3	5	1		12-008 RIGHT GABLE JOINT Q-3	5	1																			
11-545 TOP DOOR RAIL F-3	4	2		11-546 BOTTOM DOOR RAIL G-3	4	2																																																																											
08-138 PLASTIC STOPPER H-3	5	4		12-142 LEFT SIDE RECEIVER I-3	4	1																																																																											
12-143 RIGHT SIDE RECEIVER J-3	4	1		10-502 CORNER CONNECTOR K-3	4	2																																																																											
12-157 LEFT CROSSBEAM L-1	4	1		12-156 RIGHT CROSSBEAM L-2	4	1																																																																											
10-532 TRACK ML-3	4	1		10-533 TRACK MR-3	4	1																																																																											
10-505 TRACK JOINT N-3	5	1		10-506 RAFTER BRACKET O-3	5	6																																																																											
12-007 LEFT GABLE JOINT P-3	5	1		12-008 RIGHT GABLE JOINT Q-3	5	1																																																																											

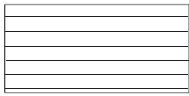
DESCRIPTION	PACKED IN BOX	QTY	DRAWING	DESCRIPTION	PACKED IN BOX	QTY	DRAWING
10-509 ROOF RAFTER CAP R-3	5	9		12-146 LEFT SIDE RAFTER S-3	4	1	
12-147 RIGHT SIDE RAFTER T-3	4	1		12-148 REGULAR RAFTER U-3	4	7	
10-513 MIDDLE ROOF JOINT V-3	5	2		10-514 MIDDLE ROOF JOINT W-3	5	6	
10-515 EDGING X-3	5	2		10-516 EDGING Y-3	5	6	
08-156 SCREW Z-3	5	14	 M4*16mm	25-114 BOLT Bb-3	5	32	 (M6*16mm)
25-115 BOLT Cc-3	5	25	 (M6*73mm)	25-117 FEMALE BOLT Cc-3-2	5	12	 M5*60mm
08-165 RIGHT DOOR LATCH Dd-R-3	5	2		08-169 LEFT DOOR LATCH Dd-L-3	5	2	
25-119 BOLT Ff-3	5	20	 (M6*12mm)	08-187 WASHER Gg-3	5	25	
10-517 END ROOF CROSS BAR Jj-3	5	2		10-518 REGULAR ROOF CROSSBAR Kk-3	5	6	

DESCRIPTION	PACKED IN BOX	QTY	DRAWING	DESCRIPTION	PACKED IN BOX	QTY	DRAWING
10-519 ROOF TOP REINFORCE Li-3	5	2		10-520 ROOF TOP REINFORCE Mm-3	5	6	
08-134 UPPER DOOR RAIL END CAP Nn	5	4		08-135 SCREW Oo-3	5	8	 (M4*12mm)
12-149 (63 1/4 x 24 1/2") LEFT+RIGHT ROOF PANEL Pp-3	1	4		12-150 (63 1/4 x 23") REGULAR ROOF PANEL Qq-3	1	12	
25-209 LEFT BACK GABLE PANEL Rr-3	1	1		25-210 LEFT FRONT GABLE PANEL Ss-3	1	1	
25-211 RIGHT BACK GABLE PANEL Tt-3	1	1		25-212 RIGHT FRONT GABLE PANEL Uu-3	1	1	
10-527 LEFT WALL GUIDE Vv-3	4	1		10-528 RIGHT WALL GUIDE Ww-3	4	1	
10-529 SCREW FOR FIXING TO WALL Xx-3	5	26		10-530 REGULAR TOP FILLER Yy-3	5	6	
10-531-L END TOP FILLER Zz-3-L	5	1		25-118 BOLT Ww	5	12	 (M5*15mm)
13-045 SELF-TAPPING SCREW PQ-3	5	4		12-161 NUT FOR 12-160 Hh-3-2	5	4	
10-531-R END TOP FILLER Zz-3-R	5	1		23-007 BOUCHON EN PLASTIQUE Kk	5	4	

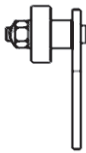
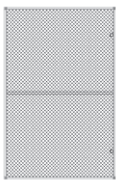
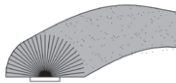
DESCRIPTION	PACKED IN BOX	QTY	DRAWING	DESCRIPTION	PACKED IN BOX	QTY	DRAWING
23-215 Allen wrench QQ	5	1	 4#	25-198 Spring leaf PP	5	40	
23-223 Allen wrench RR	5	1	 3#				

AVAILABLE REPLACEMENT PARTS			
DESCRIPTION	DRAWING	DESCRIPTION	DRAWING
10-435 PVC WINDOW (in frame)		85-014 REPLACEMENT SCREENING (no frame)	
12-176 PVC WINDOW for HALF FRAME A-3 1/2		85-417-S ROUND SPLINE FOR SCREENING	
10-493 PVC WINDOW (replacement material only)		23-096 BOTTOM STEEL PANEL (for wall panels)	
85-417-P ROUND SPLINE FOR PVC WINDOW		23-097 BOTTOM STEEL PANEL (for doors)	
15-123 PIN FOR PVC WINDOW		23-099 BOTTOM STEEL PANEL FOR HALF FRAME A-3 1/2	
13-055 PC WINDOW (for sliding door)		15-097 DOOR WHEEL ASSEMBLY	
12-174 MOSQUITO SCREEN (in frame)		10-458 REPLACEMENT WEATHERSTRIP 124"	
12-175 MOSQUITO SCREEN FOR HALF FRAME A-3 1/2		15-125 MOUNTING BRACKET FOR RAFTER (U-3)	
<b>*NOT INCLUDED IN THE BOX</b>			
<b>DESCRIPTION</b>	<b>COLOUR</b>	<b>PART #</b>	
SPRAY PAINT	SAND	11-699	
PAINT PEN		18-245	

Note: The Dimensions are approximate.

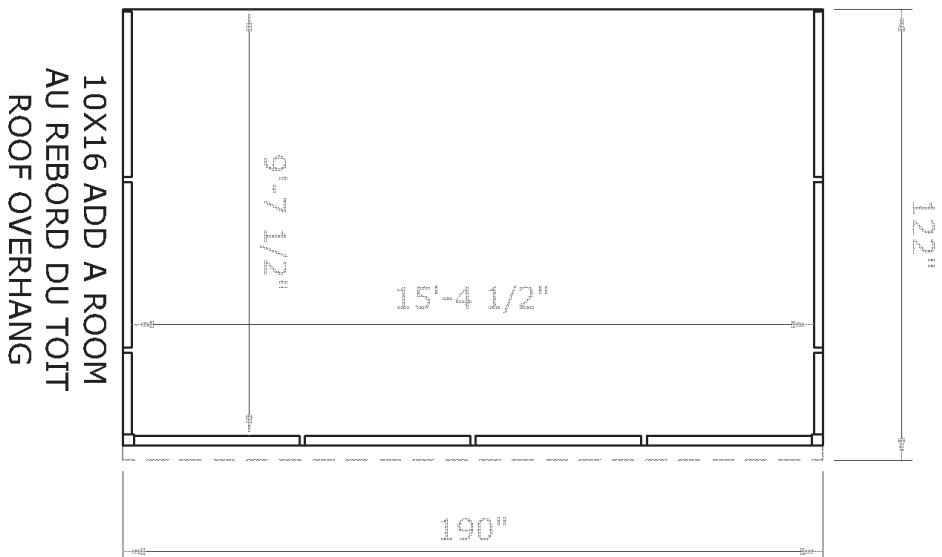
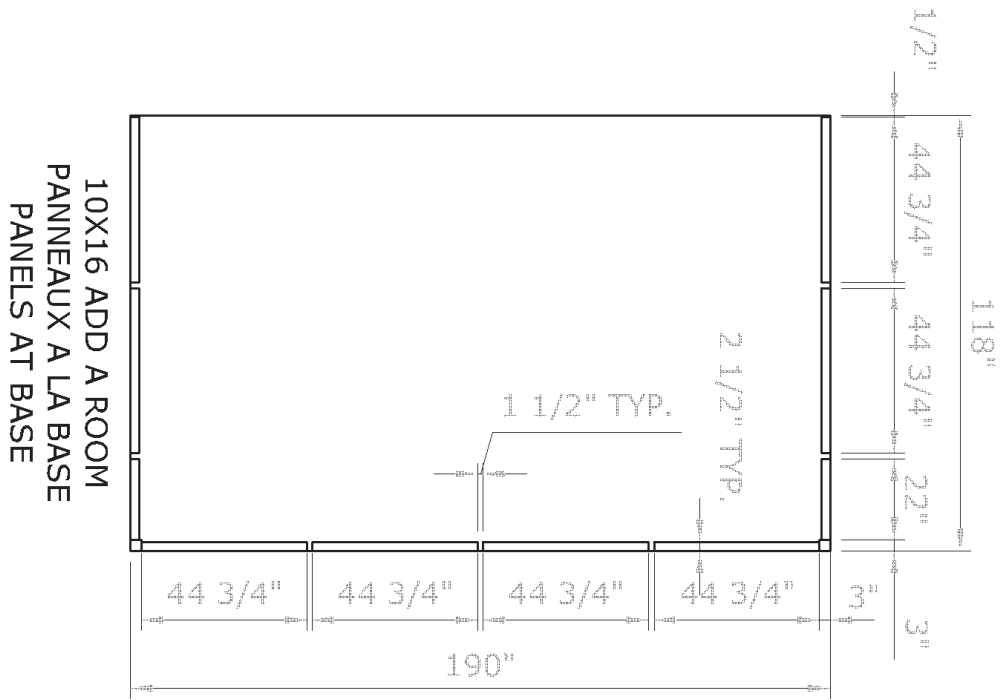

REMOVE STICKER AFTER ASSEMBLY

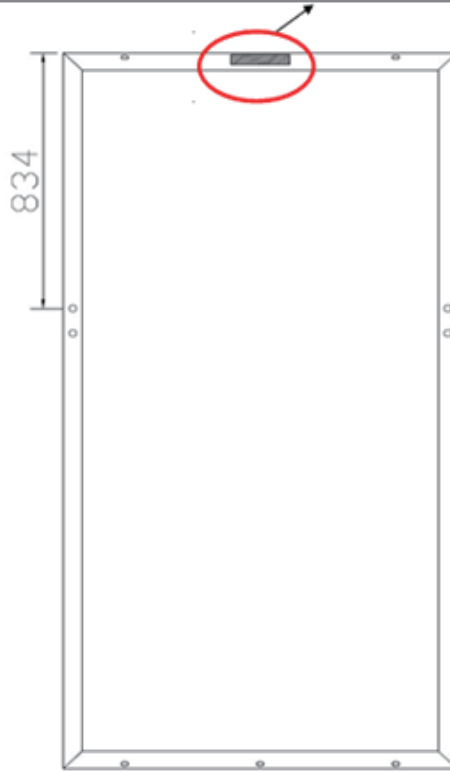
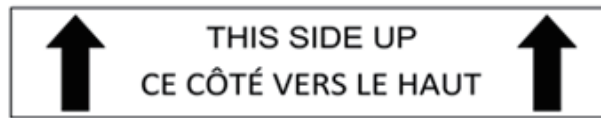

D-3 FRAME

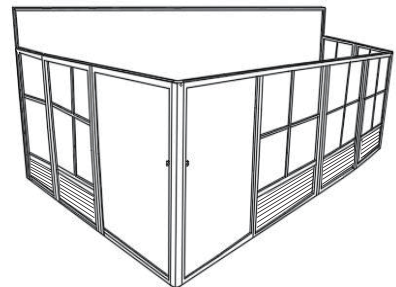
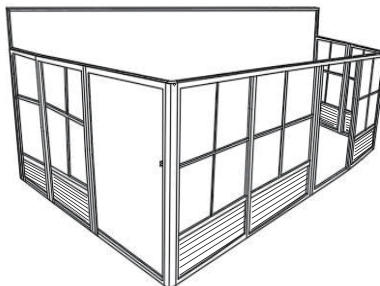
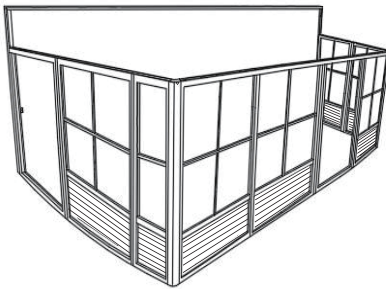

**SHOWN ARE FEW POSSIBILITIES**  
THE **SLIDING DOOR** CAN BE PLACED IN ANY LOCATION AS  
LONG AS THE **FRAME NEXT TO DOOR** IS BESIDE IT.

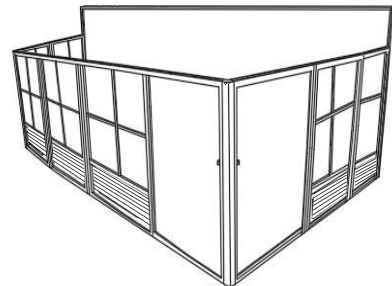
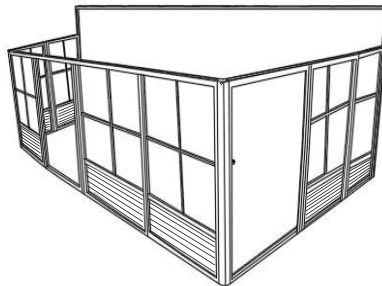
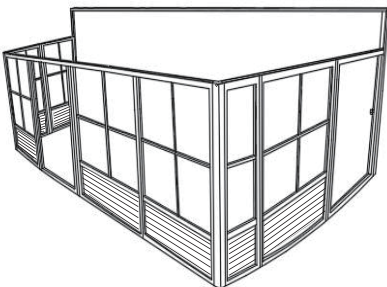

## **TOOLS REQUIRED:**

- Screwdriver
- Knife
- File (smooth)
- Needle-nosed pliers
- Rubber mallet
- Step ladder (minimum 6' in height)
- Spatula
- Power drill
- Tube of silicon
- Drill bit 5/16" cement  
(according to surface)

## **BEFORE STARTING:**

Ensure that you have a solid base, such as concrete or wooden deck, not slanted more than 1" per 8'. Avoid installing unit adjacent to trees or a sloped roof, as snow and ice may slide onto the solarium and cause it to collapse. Please don't destroy boxes until completely assembled.

## **Door placement direction:**

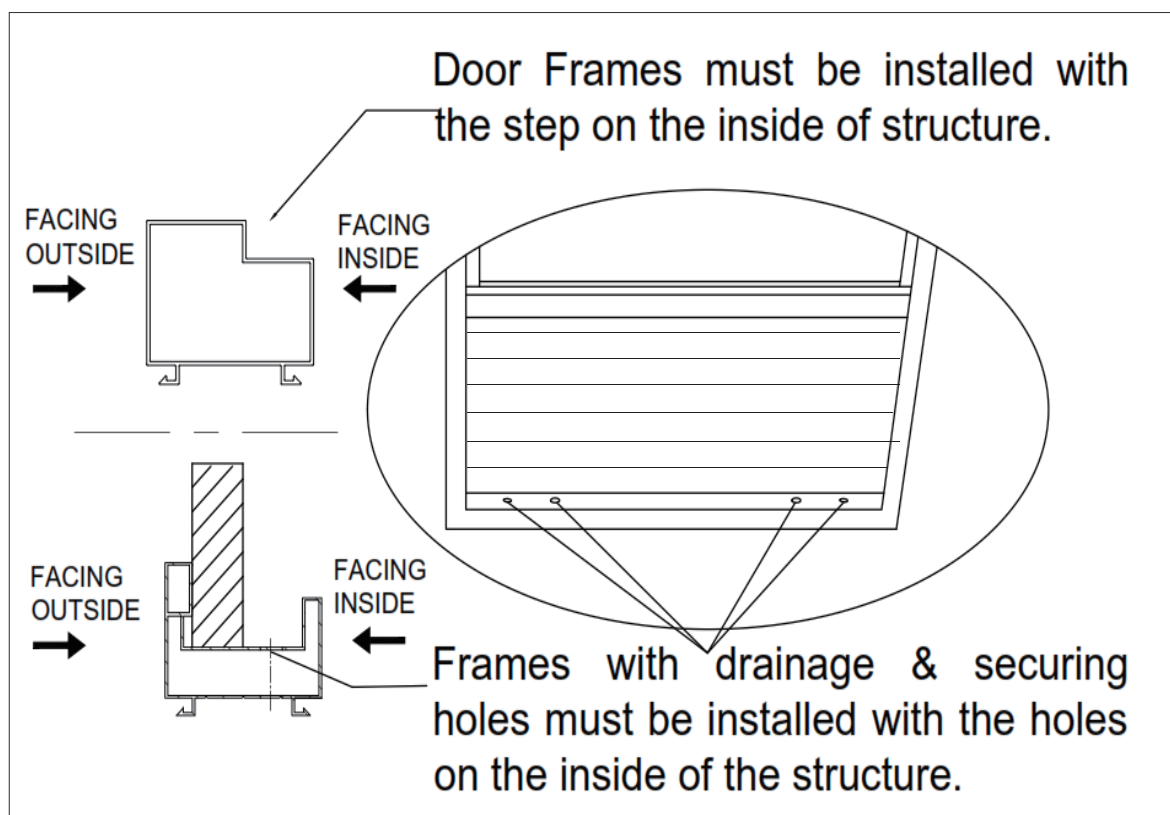

## Step 1

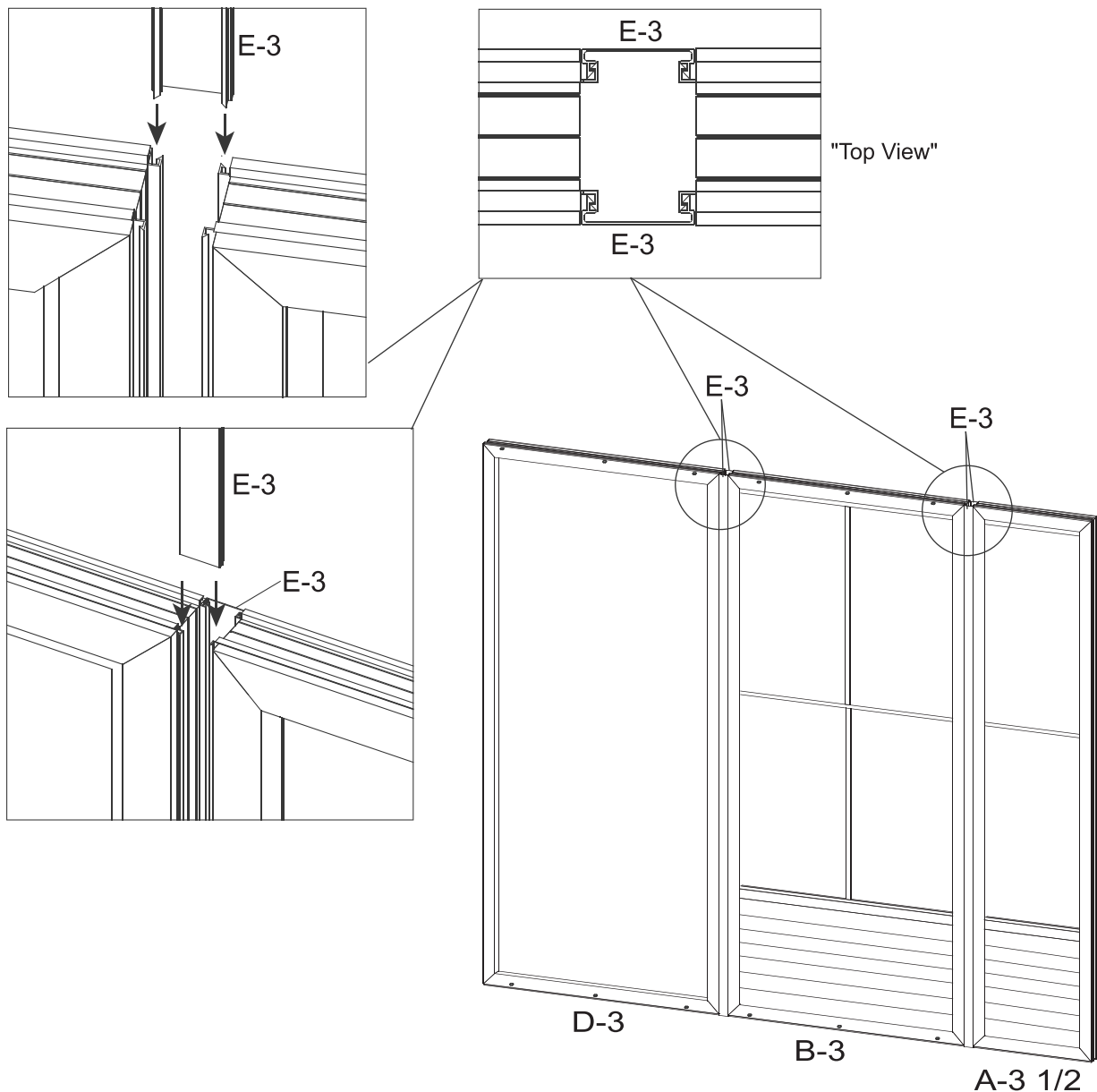

1.1 Decide the position of the door frames before assembly according to where you intend to slide the door. At the front of the solarium, use frame D3 for the opening of the door and B3 for the direction of the door when open.

1.2 Align the Sliding Door Frame (D-3) with the Frame Next To Door (B-3), then insert the Connecting Piece (E-3) between the Sliding Door Frame (D-3) and the door frame (B-3). Align the Door (B-3) with the Frame Next To Door (A-3 1/2), then insert the Connecting Piece (E-3) between the Door (B-3) and the Frame Next To Door (A-3 1/2).

### NOTE:

When sliding the connectors, shake the frame so that they will slide easily. Do not use tools to force it. If needed, clean the paint with a file and make sure the ends of the frame and joints are not bent or warped. If so, use the needle-nosed pliers to straighten.

## Step 2

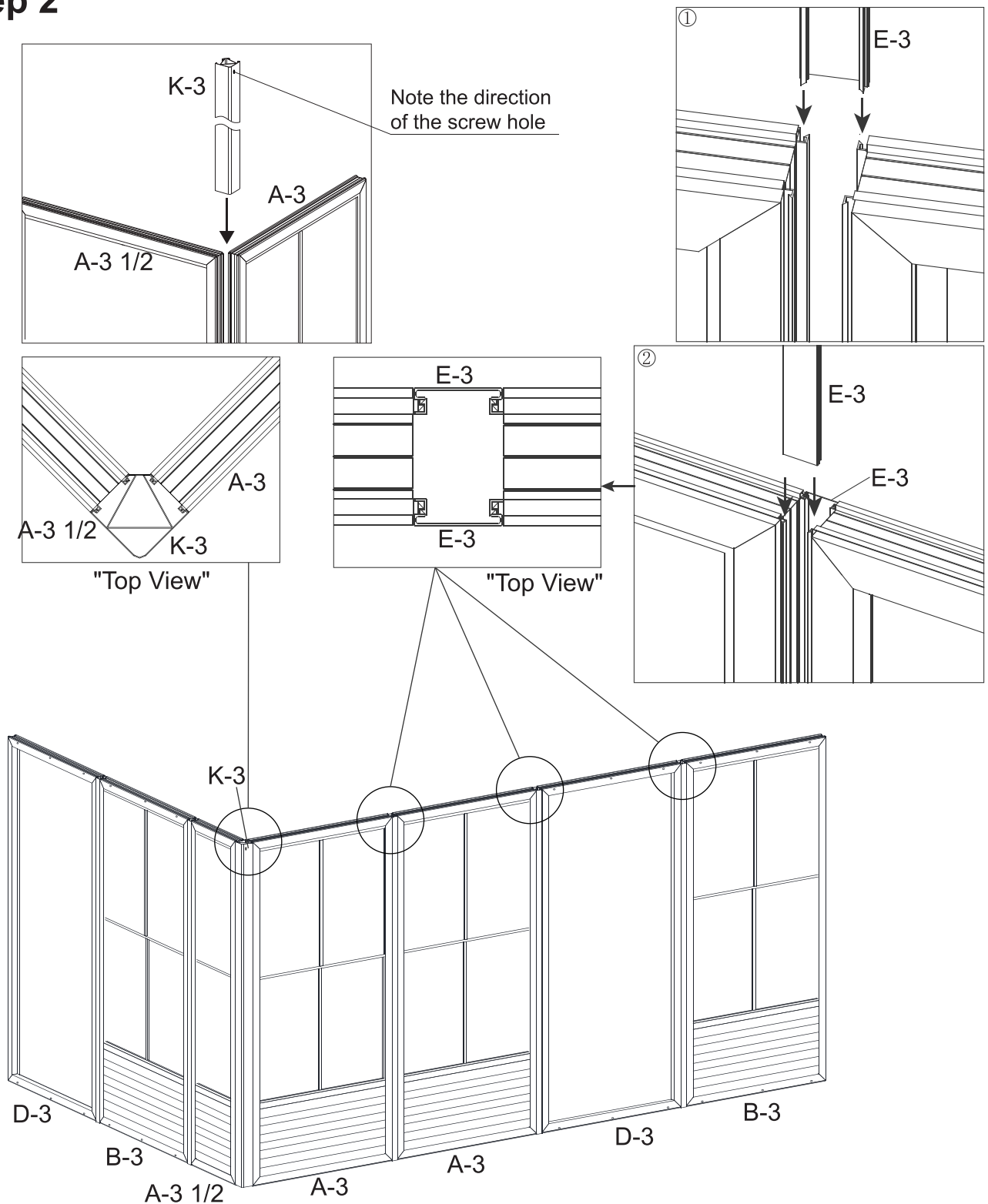

2. Connect the Regular Frame (A-3), Sliding Door Frame (D-3) and Frame Next To Door (B-3) with Corner Connector (K-3) and Connecting Piece (E-3) connected together, Corner Connector (K-3) with bolt holes facing up and out. Sliding Door Frame (D-3) with sticker with arrow pointing upwards. (See sketch on page 8)

**NOTE:** When placing the door frame opening, make sure the inserts on the frame are on the inside and on the upper half of the frame of the solarium because the door will be set on the inside due to clearance.

## Step 3

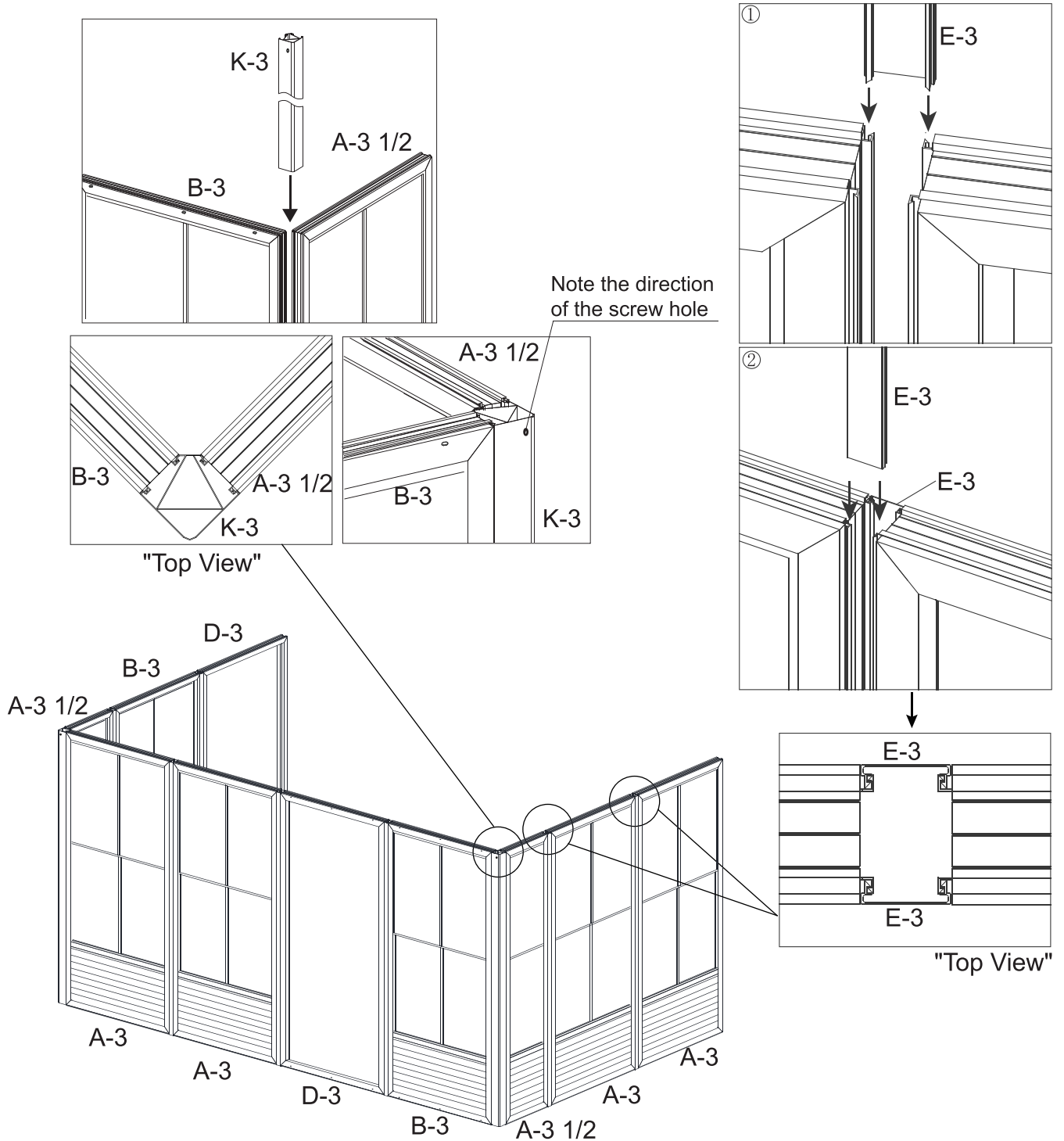

3. Connect the remaining Regular Frame (A-3) and Frame (A-3 1/2) with Corner Connector (K-3) and Connecting Piece (E-3). (See sketch on page 8)

**NOTE:** When placing the door frame opening, make sure the inserts on the frame are on the inside and on the upper half of the frame of the solarium because the door will be set on the inside due to clearance.

## Step 4

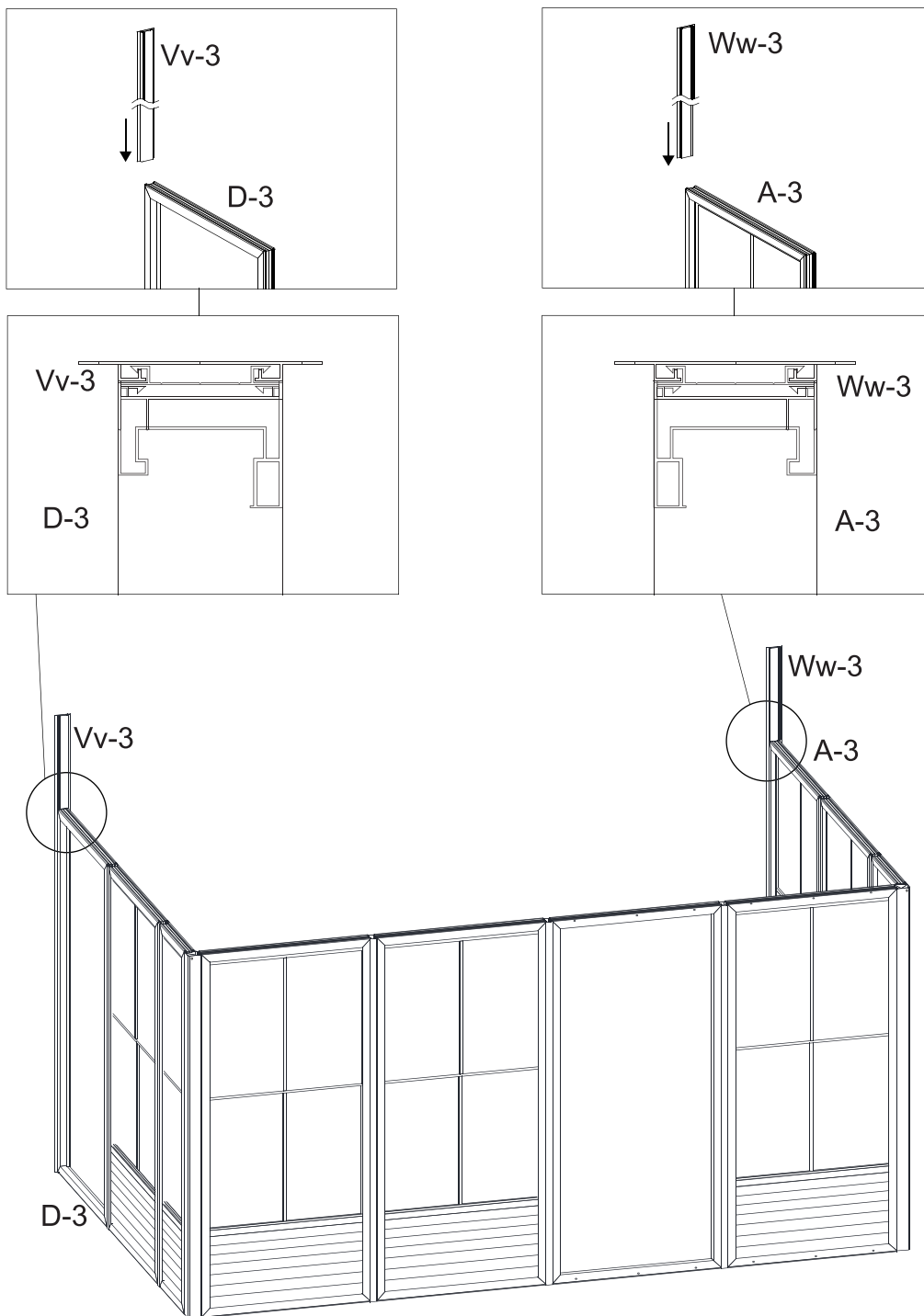

4. Slide the Left Wall Guide (Vv-3) and Right Wall Guide (Ww-3) into the 2 ends of the frames along the grooves, shaking while sliding for easier movement.

Note: Channel Grooves should remain to the outside on both Vv-3 and Ww-3.

## Step 5

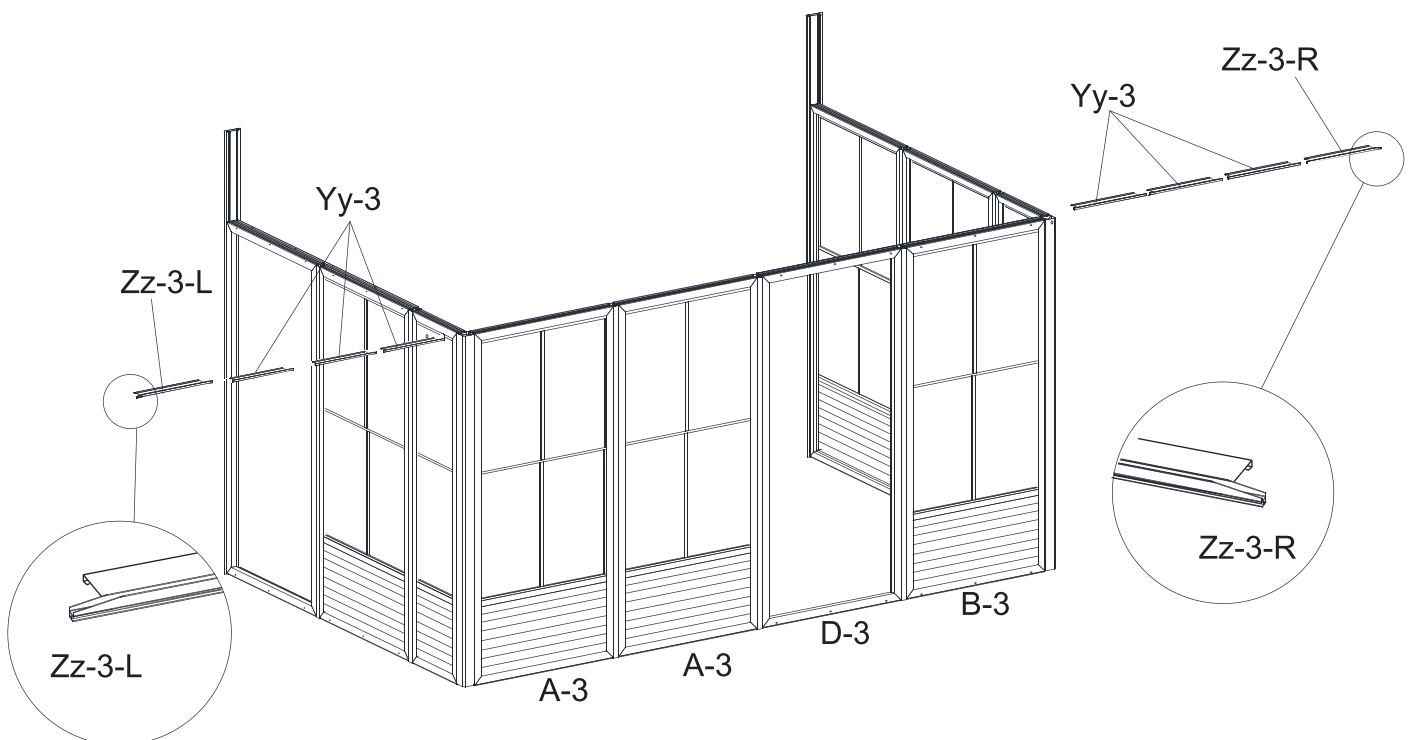
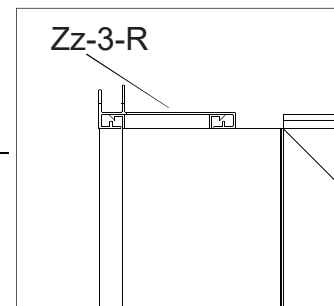
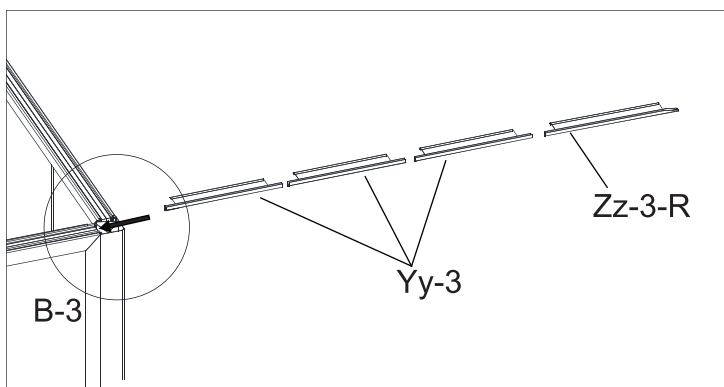
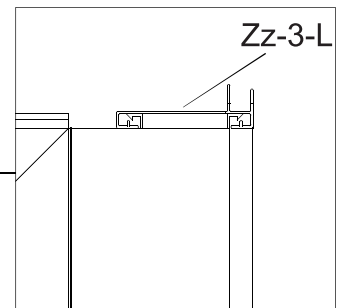
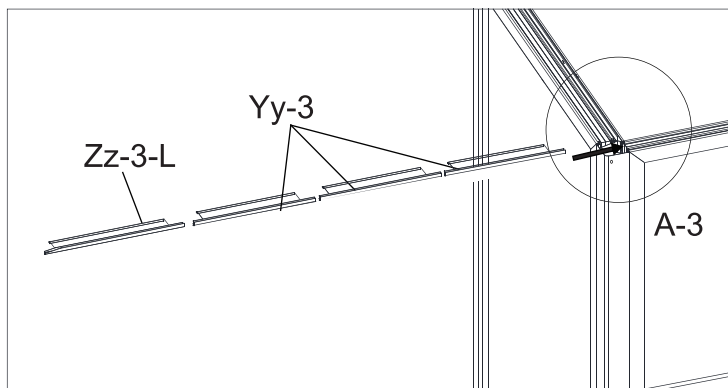

5. Slide three Regular Top Filler (Yy-3) and one End Top Filler (Zz-3-L) from the left side to the right on top of the frame. The groove should be towards the interior of the unit. Repeat from the right side with two Regular Top Filler (Yy-3) and one End Top Filler (Zz-3-R) and space evenly.

## Step 6

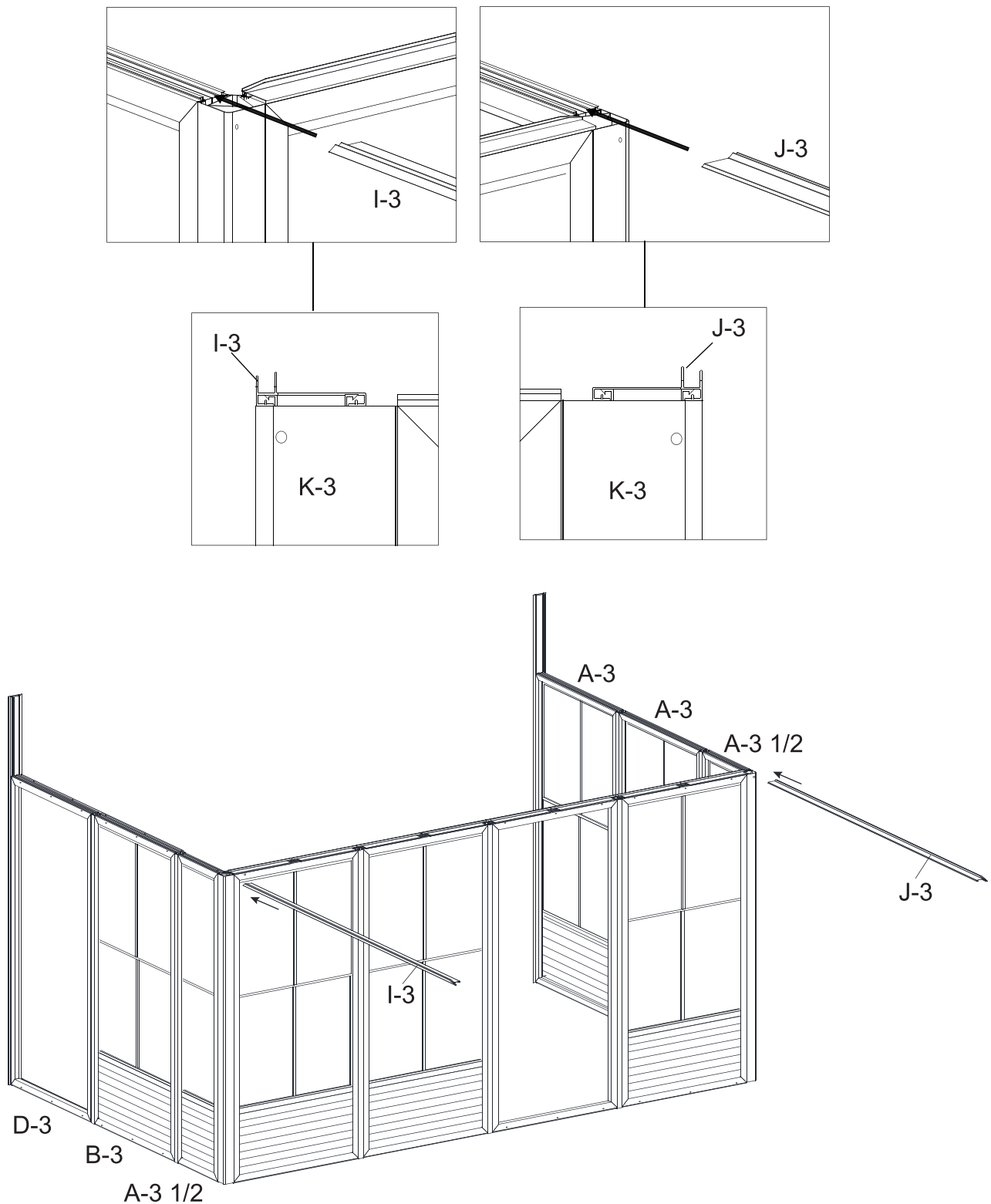

6. Insert the Left Side Receiver (I-3) and Right Side Receiver (J-3) at the top of the frame. Make sure the 2 frames are at the correct level, if not, use shims to compensate. Do not use tools to force them into place.

## Step 7

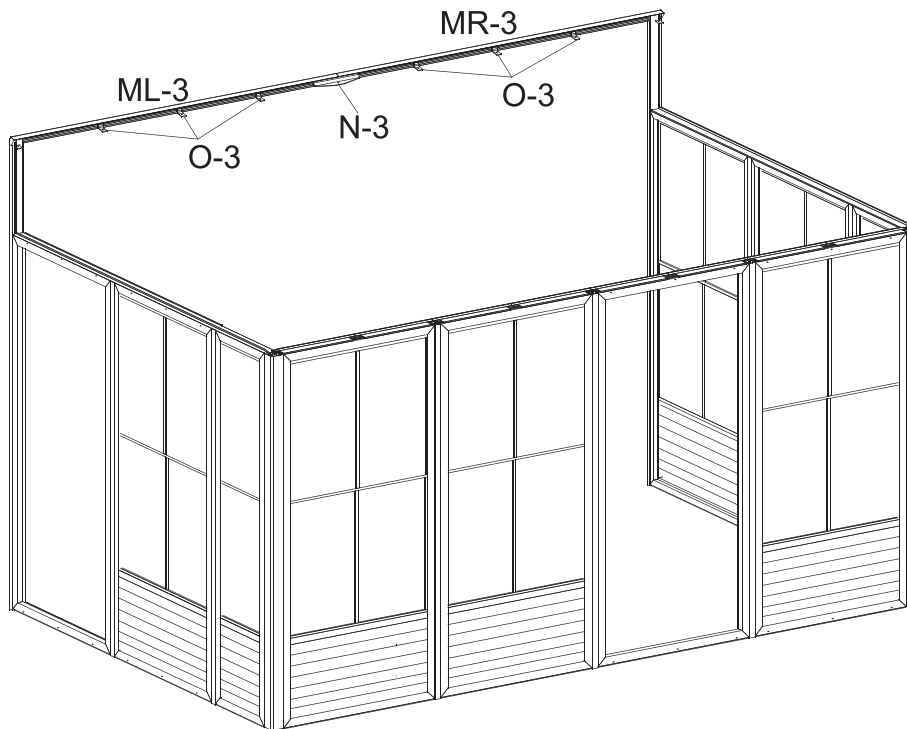
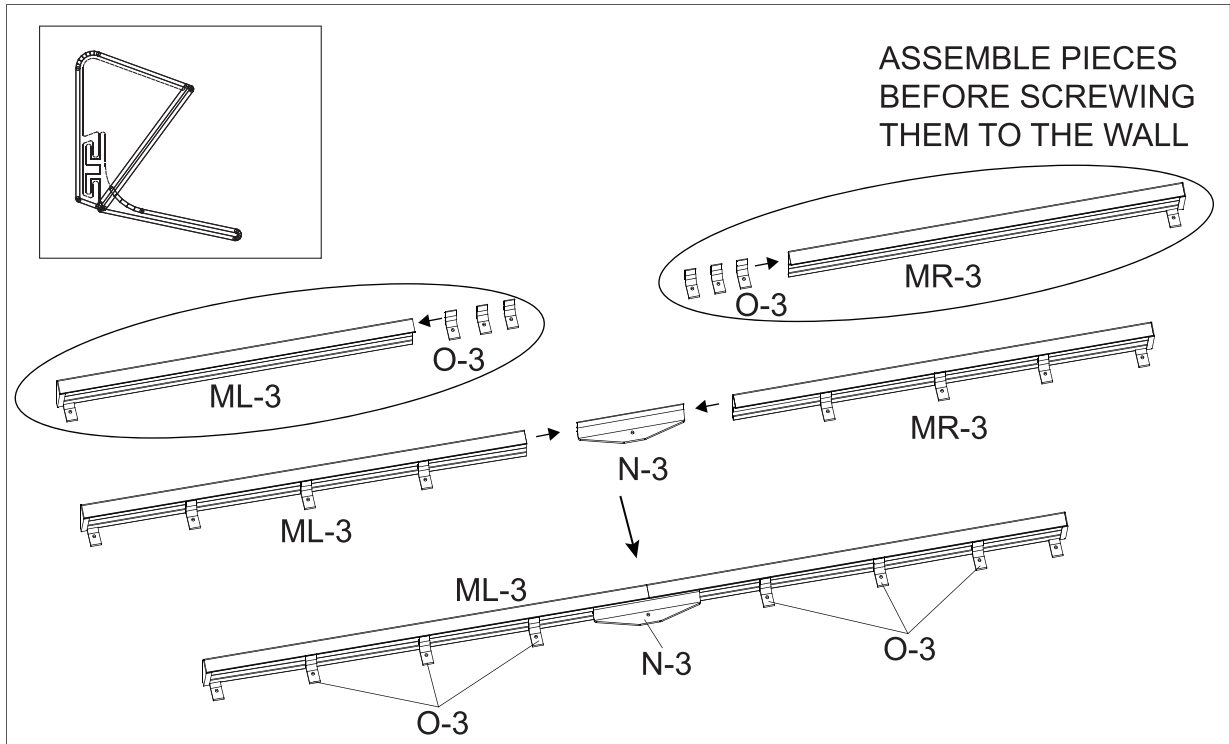

7. Assemble ML-3, N-3, O-3, and MR-3 as shown and position evenly above vertical guides, at 97" from the ground. Secure wall track and vertical tracks to brick or cement wall by drilling through the aluminum, at intervals of 16" (minimum) and using screws Xx-3. Or other fasteners according to wall material (Not Supplied). Insert the 2 horizontal guides, I3 & J3 at the top of the frame. Make sure the 2 frames are at the correct level, if not, use shims to compensate. Do not use tools to force.

**NOTE:** Once the wall track is in place, apply silicon along the top of the wall track and at the joint of the two vertical tracks.

**Silicone is not supplied.**

## Step 8

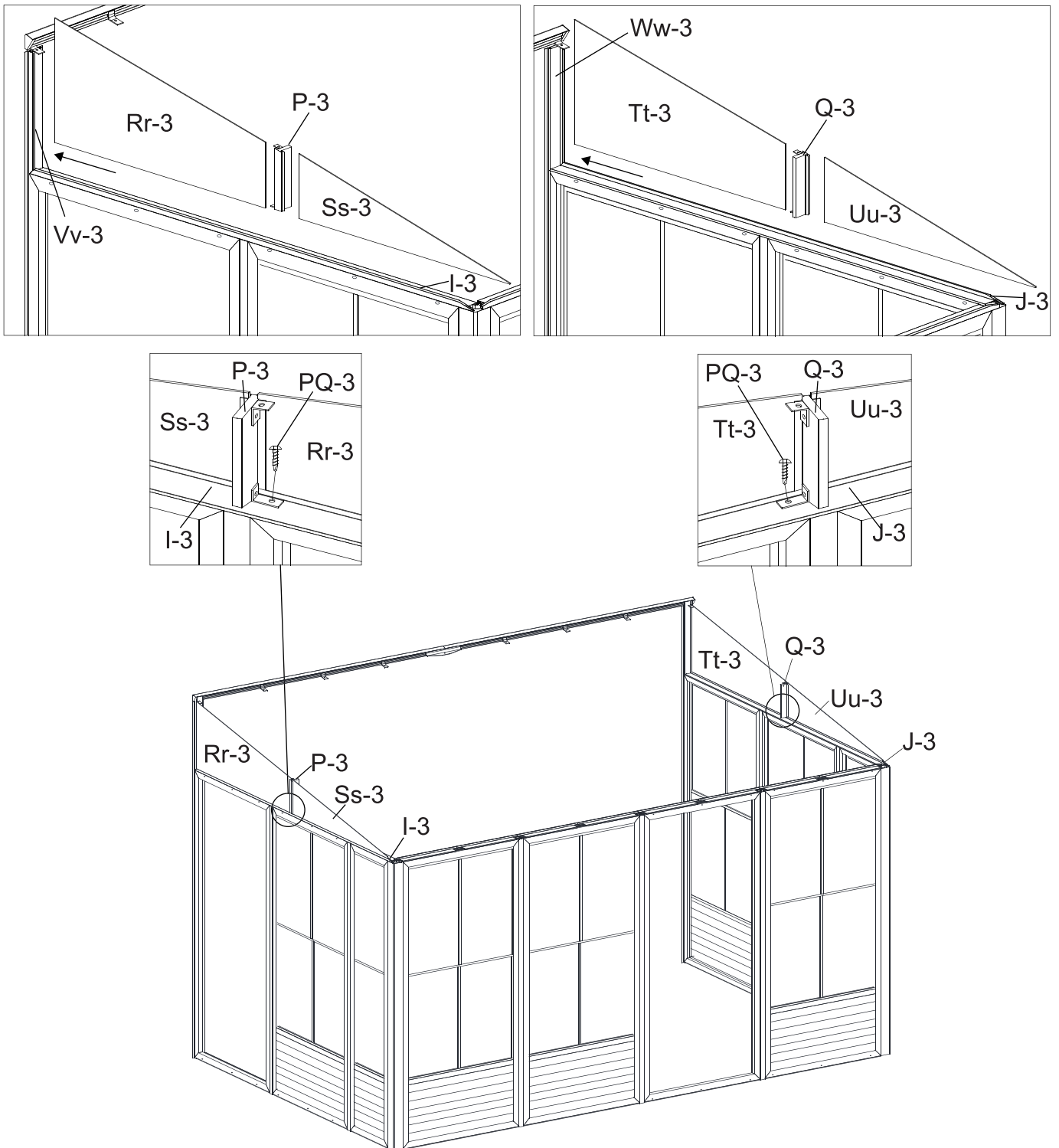

8. Set polycarbonate exposed side on the outside over horizontal left Side Receiver (I-3), use one Left Back Gable panel (Rr-3), one Left Gable Joint (P-3) and one Left Front Gable panel (Ss-3) , then do the right side with one Right Back Gable panel (Tt-3), one Right Gable Joint (Q-3) and one Right Front Gable panel (Uu-3) over the Right Side Receiver (J-3) horizontal panel. Secure Gable Joint (P-3) and (Q-3) to Side Receiver (I-3) and (J-3) respectively with self-tapping screws (PQ-3).

## Step 9

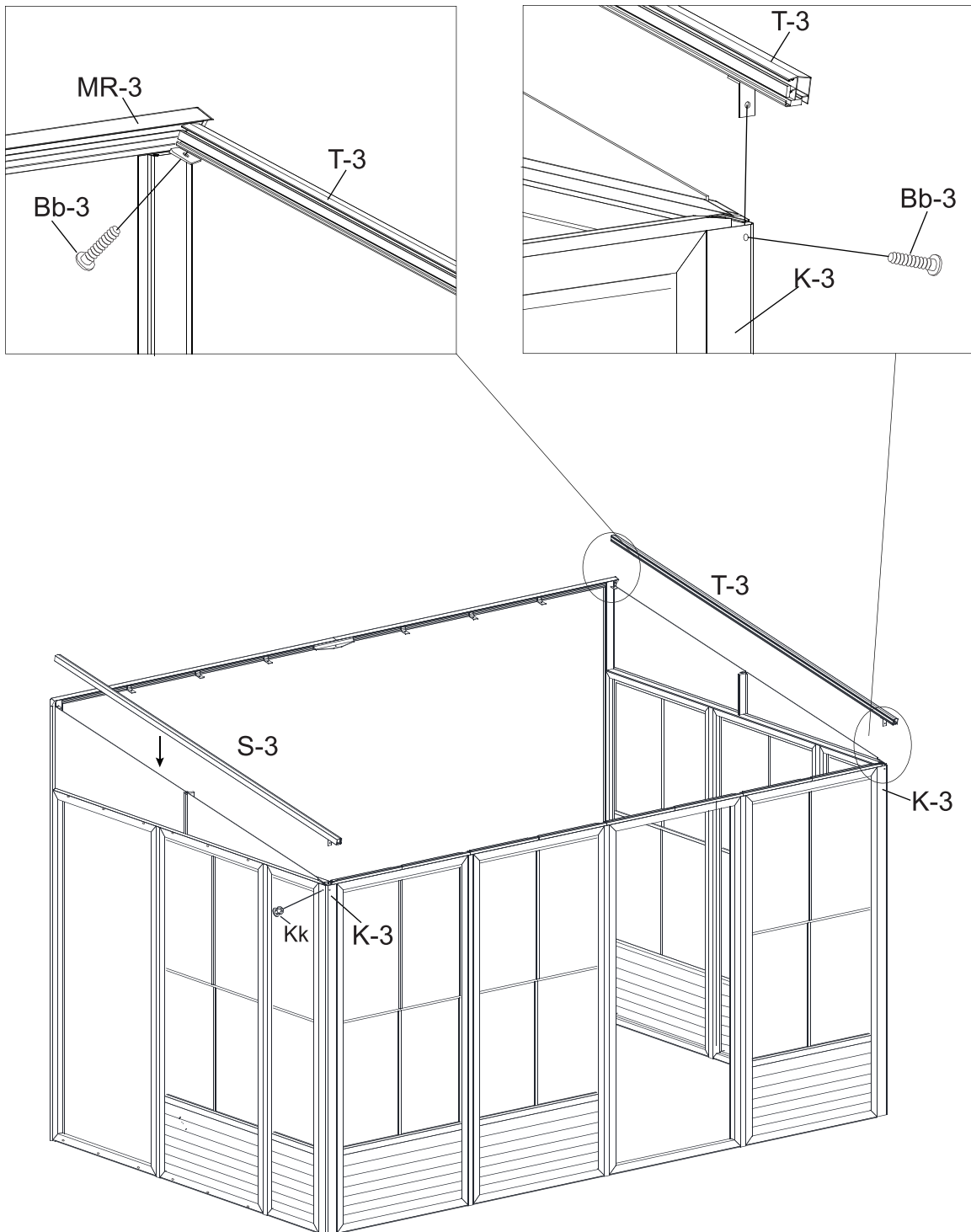

9. Set Right Side Rafter (T-3) over last bracket then secure to Corner Connector (K-3) and to Right Gable Joint (Q-3) bracket with screw (Bb-3). Repeat on left side with Left Side Rafter (S-3).

## Step 10

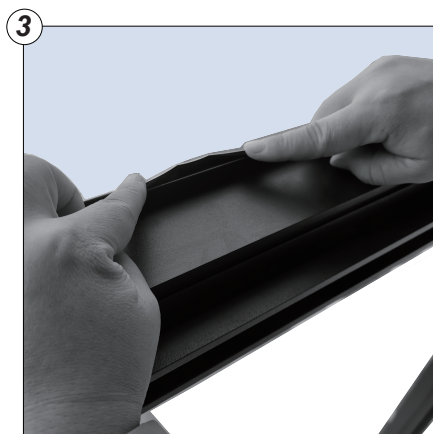
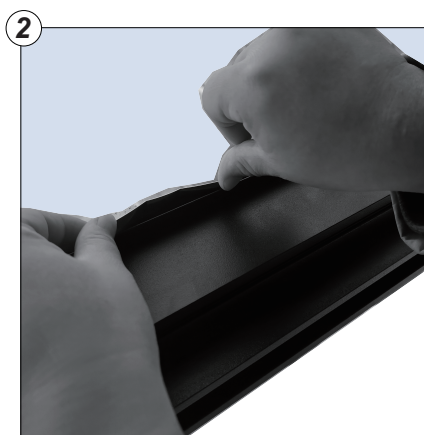
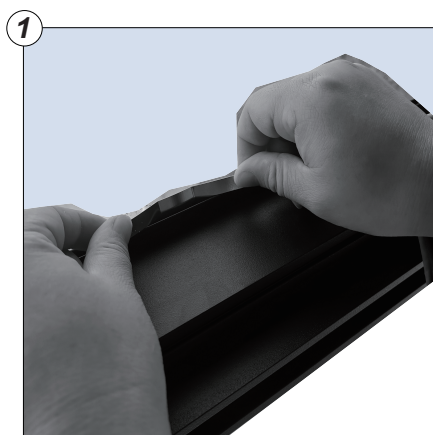
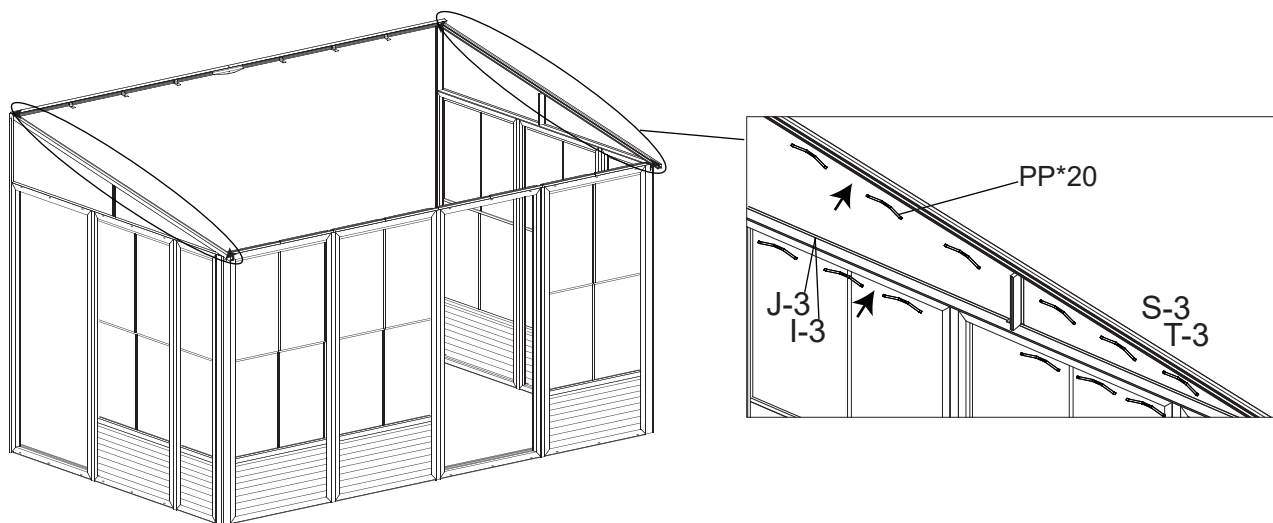

10. Install the Spring leaf (PP) into the inner groove of the Siderafter (T-3/S-3) and Side Receiver (I-3/J-3). It is used to hold the Solid Panel in place.

## Step 11

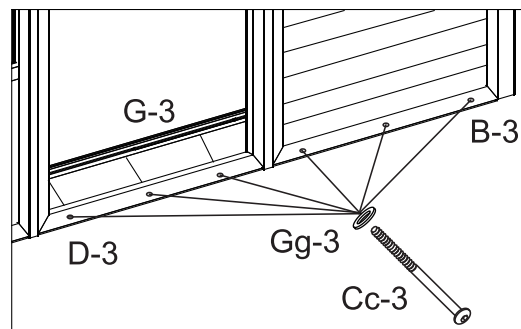
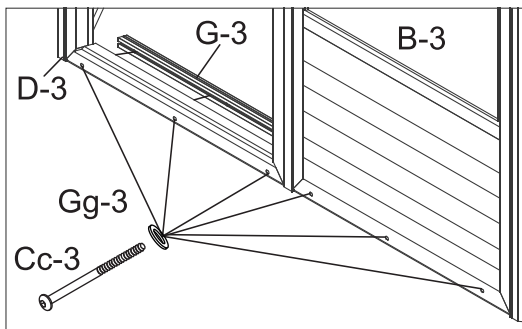
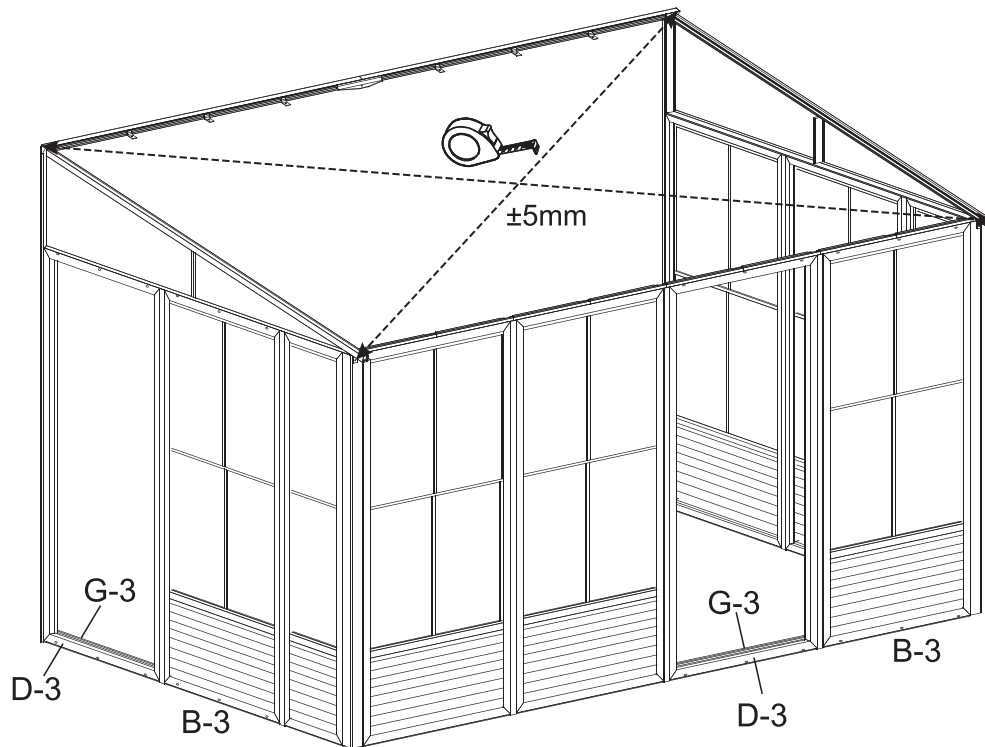

11. Attach the Sliding Door Frame (D-3), Frame Next To Door (B-3) and Bottom Door Rail (G-3) together with bolts (Cc-3) and washers (Gg-3).

**NOTE:** Be sure measurements diagonally across the overall frame are within 5mm of the same distance after completing this step

## Step 12

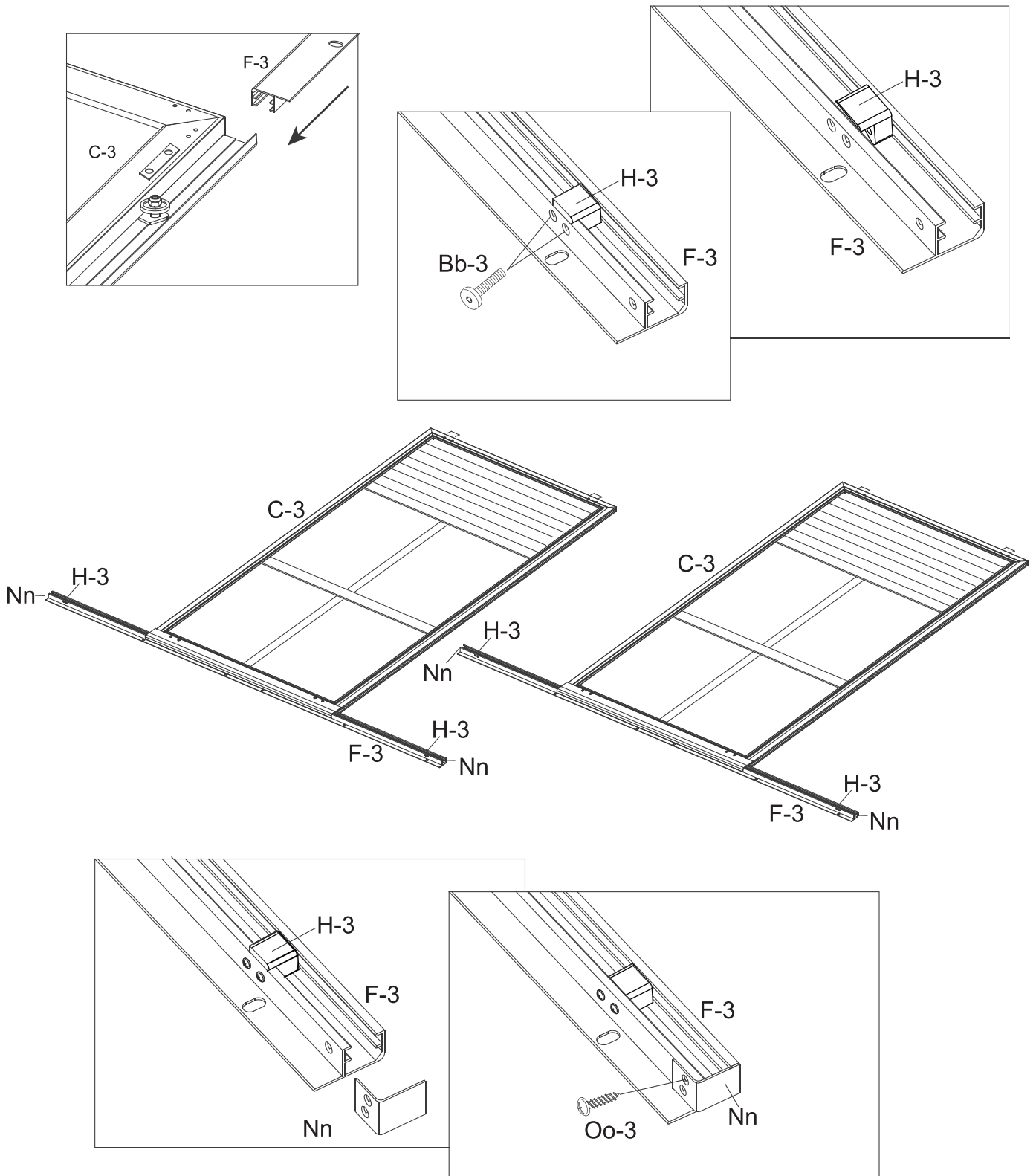

12.1 Insert the Top Door Rail (F-3) into the connect piece on the top of the Sliding Door (C-3).

12.2 Fix the Plastic Stopper (H-3) onto the both ends of the Top Door Rail (F-3) by using the Bolts (Bb-3).

12.3 Fix the Upper Door Rail End (Nn) onto the both ends of the Top Door Rail (F-3) by using the Bolts (Oo-3).

# Step 13

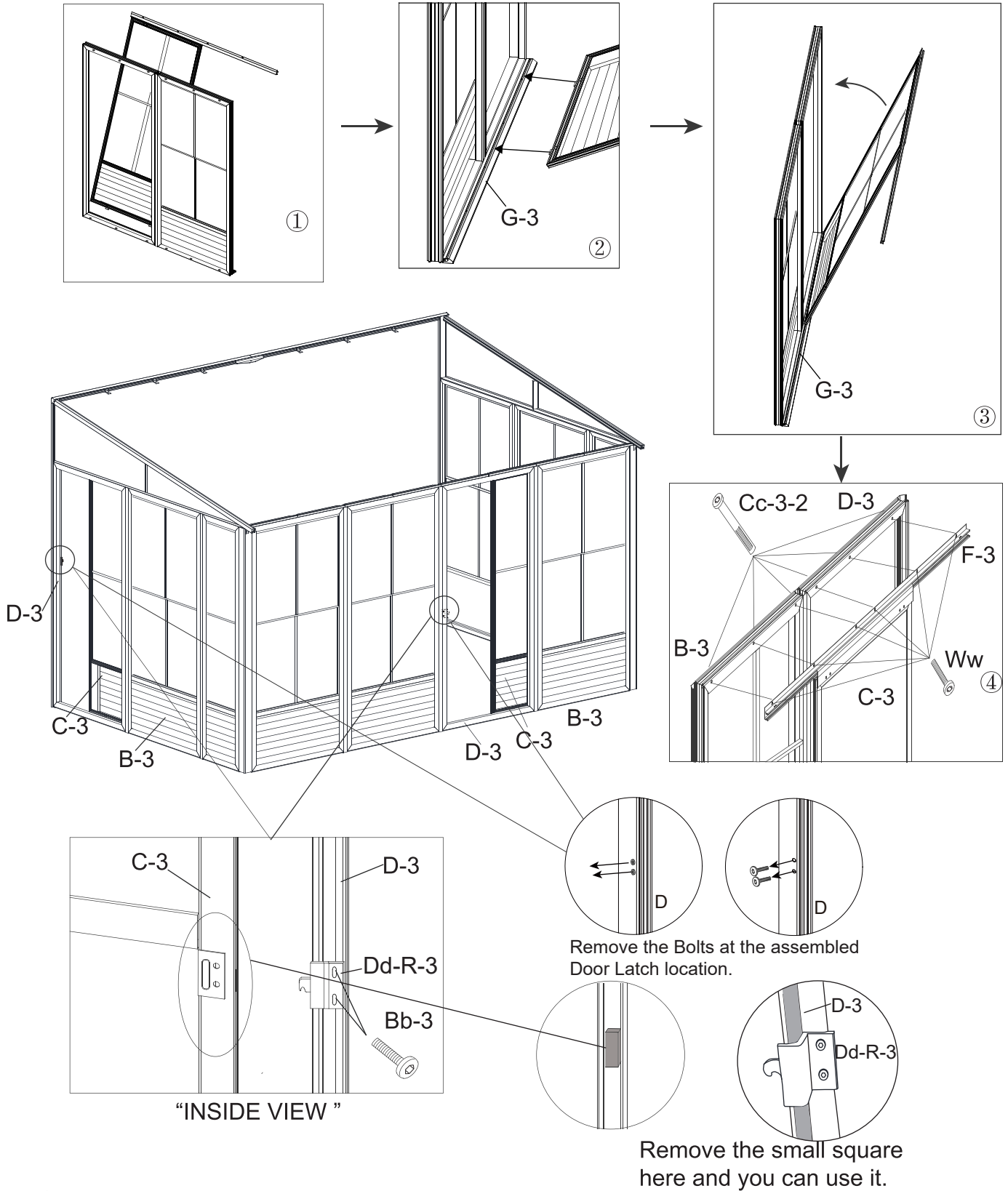

13.1 Put the assembled Sliding Door (C-3) upright, insert the lower end into the Bottom Door Rail (G-3), and fix the upper end with Bolts (Cc-3- 2/Ww).Make sure to push up the upper door track (F-3) so that the doors does not rub against the bottom track.

13.2 Fix the Right Door Latch (Dd-R-3) with the Sliding Door Frame by using the Bolts (Bb-3).

## Step 14

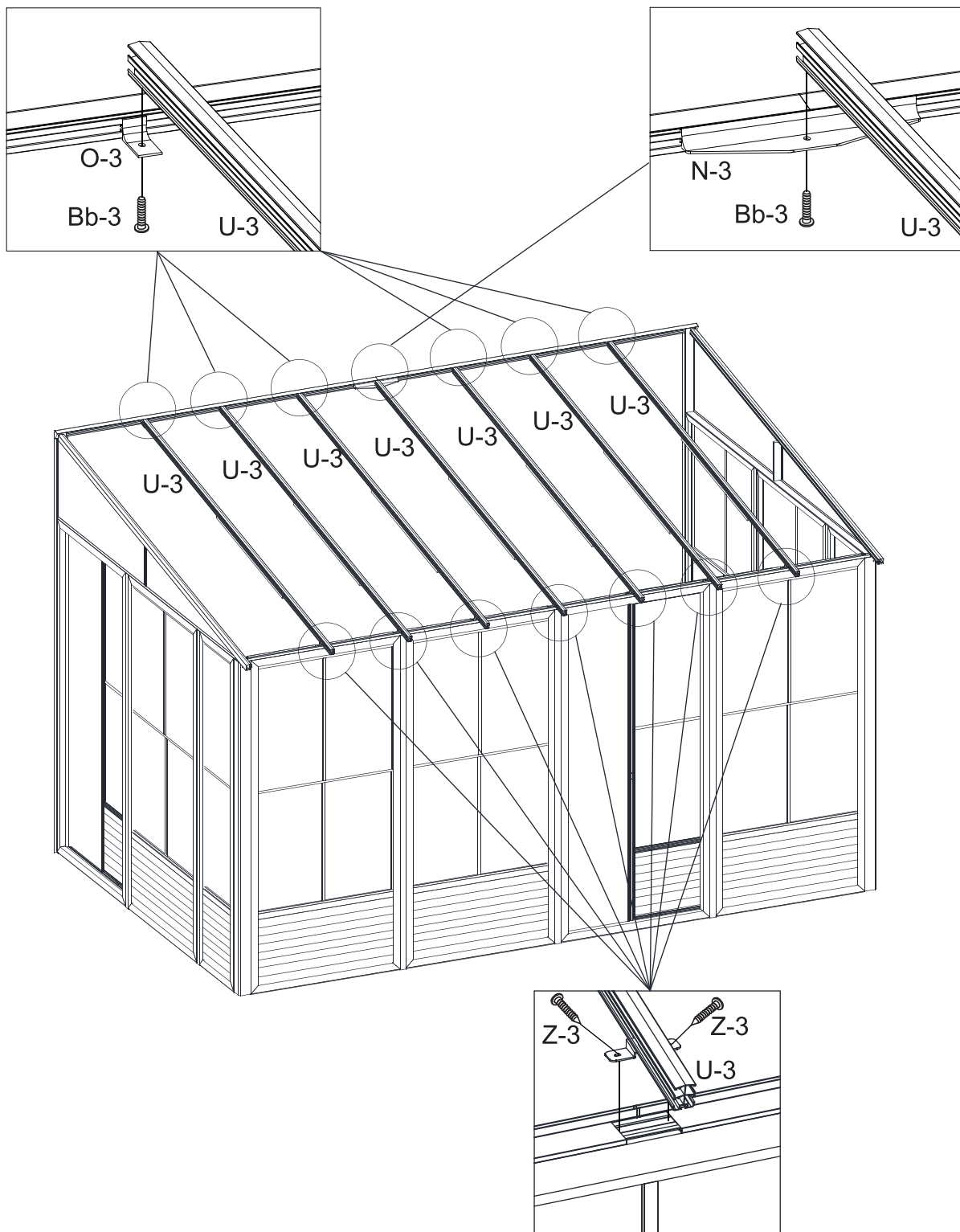

14. Set (U-3) rafters over the middle of each panel with Bb-3 screws at the top and two (Z-3) screws over the brackets on frame manually. Set (U-3) rafter on each joint and use (Z-3) screws manually. Do not use power drill.

# Étape 15

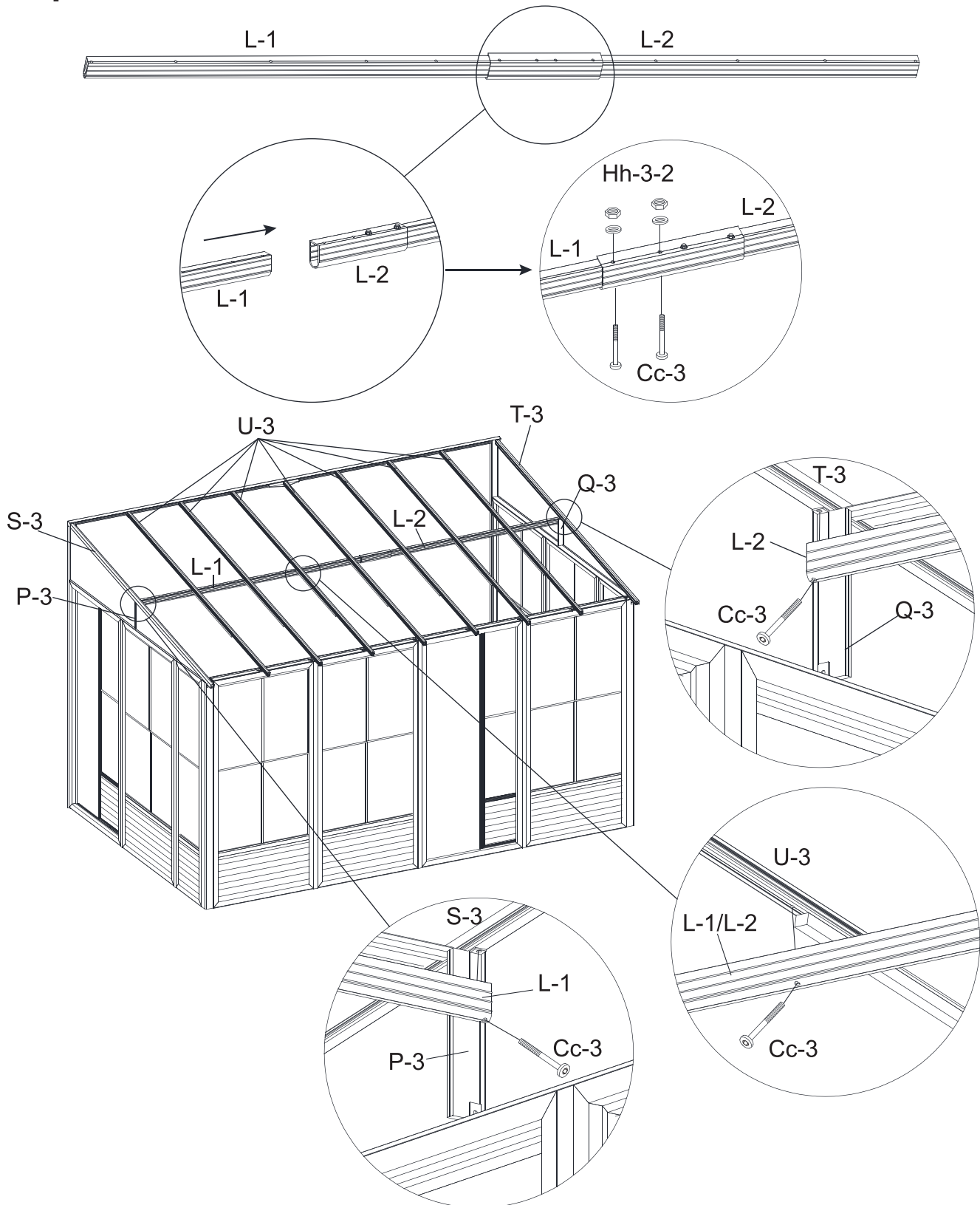

15.1 .Use Bolt (Cc-3) and Nut (Hh-3-2) to assemble Crossbeam L-1 and Crossbeam L-2 together.  
15.2. Attach the assembled Crossbeam (L-1) and Crossbeam (L-2) to the Left side rafter (S-3) and Right side rafter (T-3) through Gable Joint (P-3) and Gable Joint (Q-3), connect the middle to the Regular rafter(U-3),and fix them with Bolt (Cc-3).Tighten the Bolts manually.

## Step 16

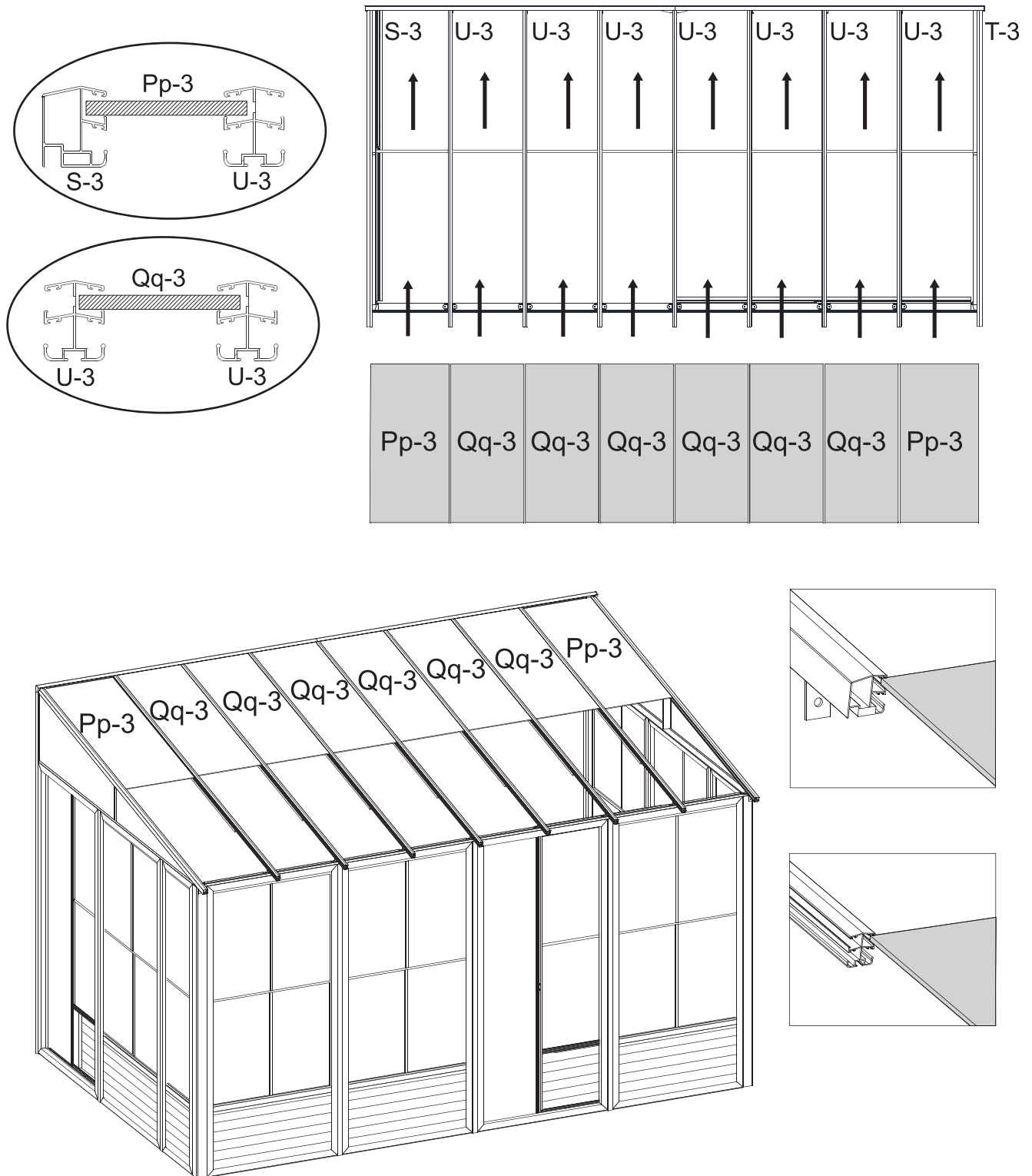

16. Remove protective film from two sides of each panel and make sure the top side of the panel faces the sunlight. Insert and slide on the top groove of the rafters all the way to the end. Roof panel (Pp-3) should go first and last with the Roof panel (Qq-3) panels in between. Note: the side that had the protective layer should face down and the one with the UV protection to be facing up.

## Step 17

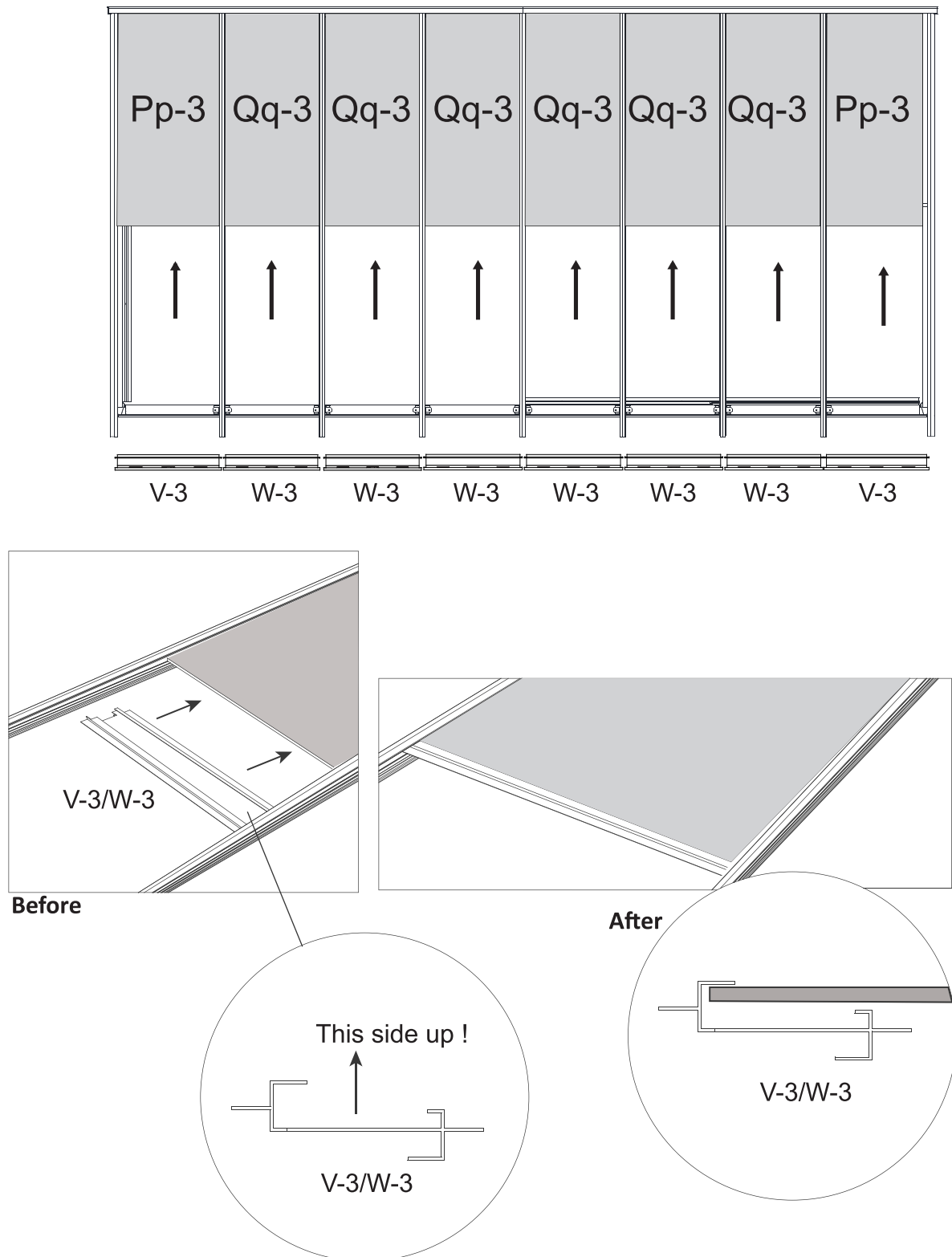

17. Insert the aluminum middle roof joint between the rafters, making sure the slotted holes are at the bottom. Slide into upper and lower grooves of the rafters then slide all the way into the panels. Make sure the panels are inside the aluminum middle roof joint groove. Insert a (V-3) at either end, then insert all (W-3) and then the remaining (V-3). Tap gently with rubber mallet if needed.

# Step 18

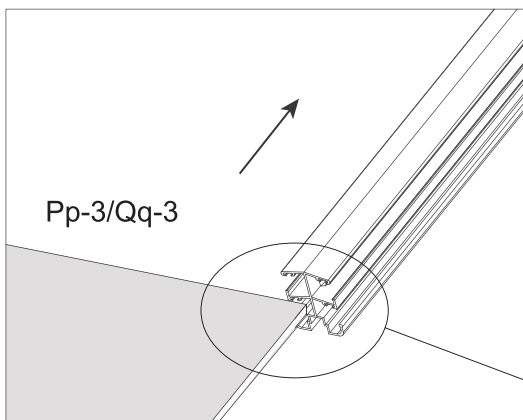
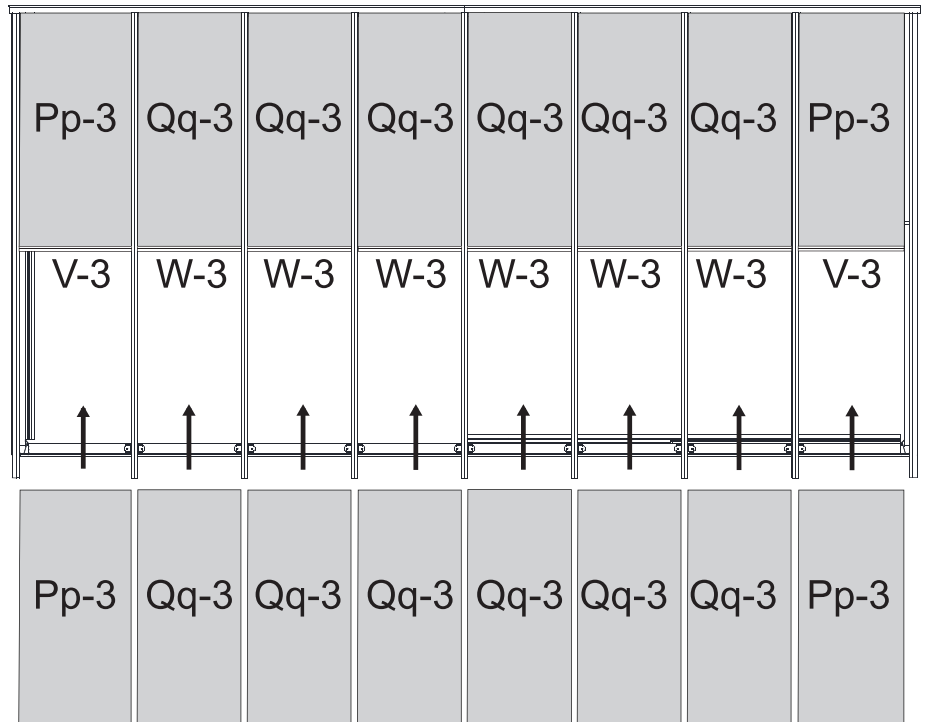
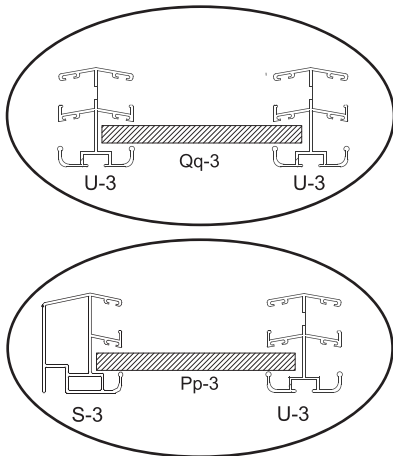

Note: "Make sure the one with the UV protection to be facing up."

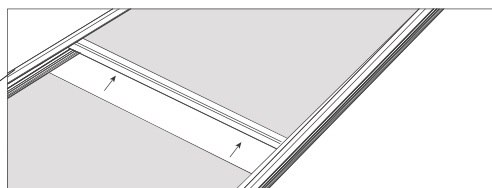

**Before**

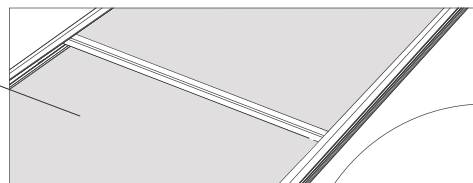

**After**

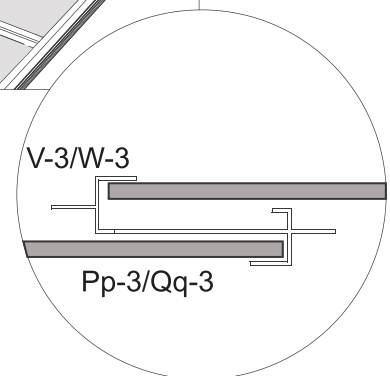

18. Insert the second row of panels into the lower groove on the rafter. Slide panels until they reach the aluminum pieces between the panels and gently tap on the panel to guide it into the aluminum groove. Use a spatula if needed to make it fit. Insert two (Pp-3) on either end, then insert the (Qq-3) panels.

# Step 19

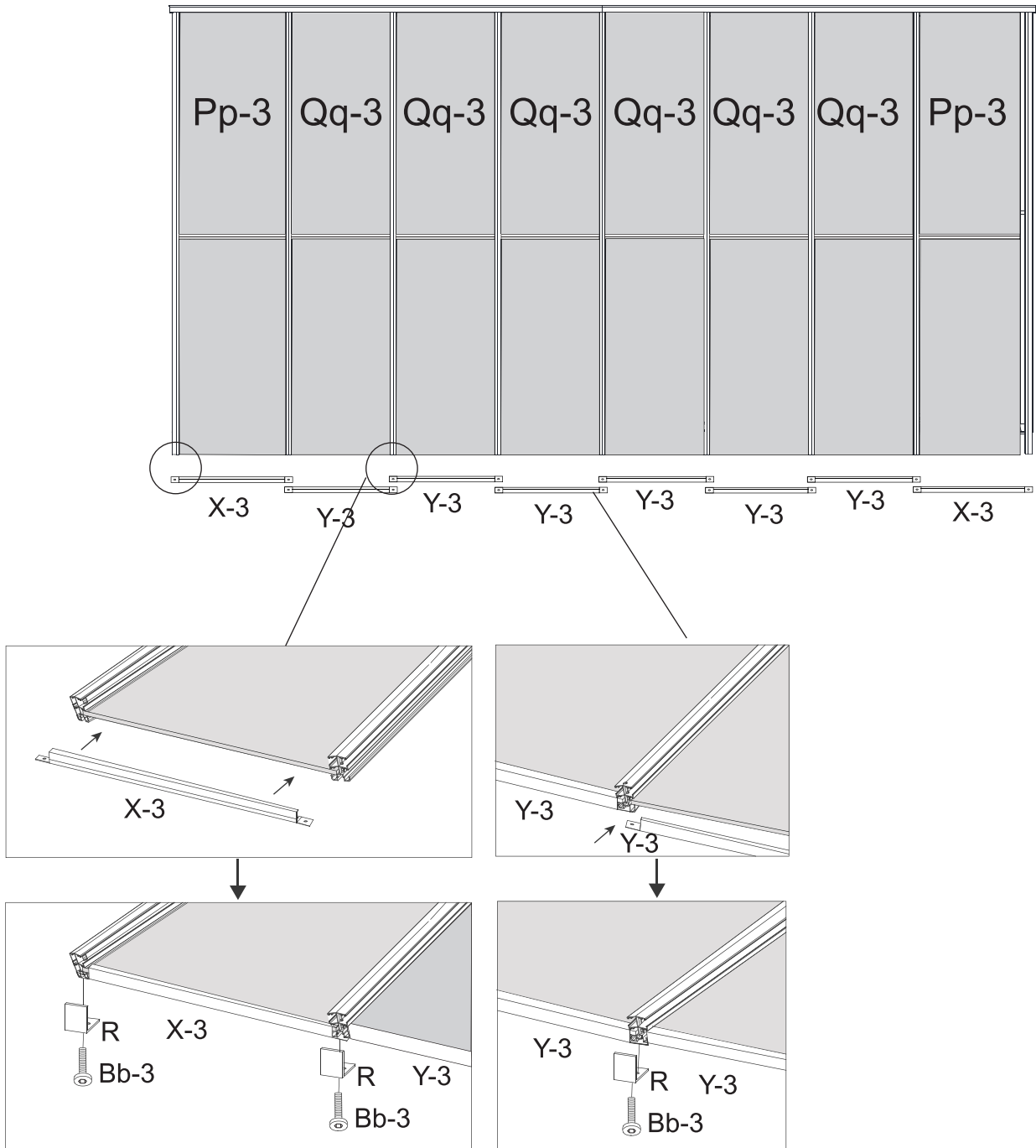

19. Starting at either end, add (X-3) edging and one (R-3) bracket and screw with (Bb-3) manually, do not use power drill. Add (Y-3) edging and repeat until you reach the end, then add the (X-3) edging.

## Step 20

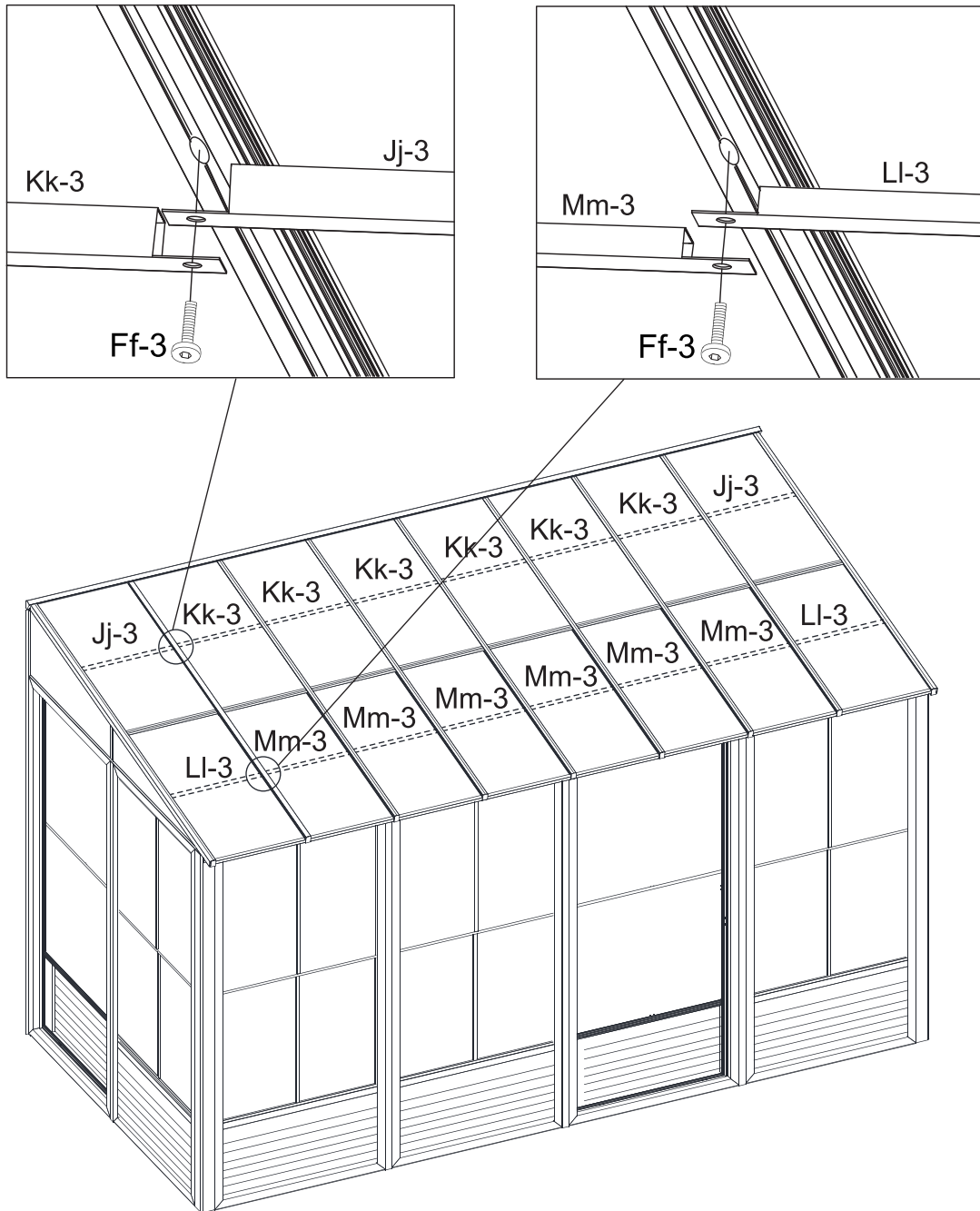

20. On the inside of the solarium under each rafter there are two rows of inserts with threads. Start the upper row with a (Jj-3) at either end and screw it with (Ff-3) and in between the (Kk-3) panels. Use (Ff-3) screws at the lower row (Ll-3) at the 2 ends then the others in between the (Mm-3) panels. Make sure screws are manually tight.

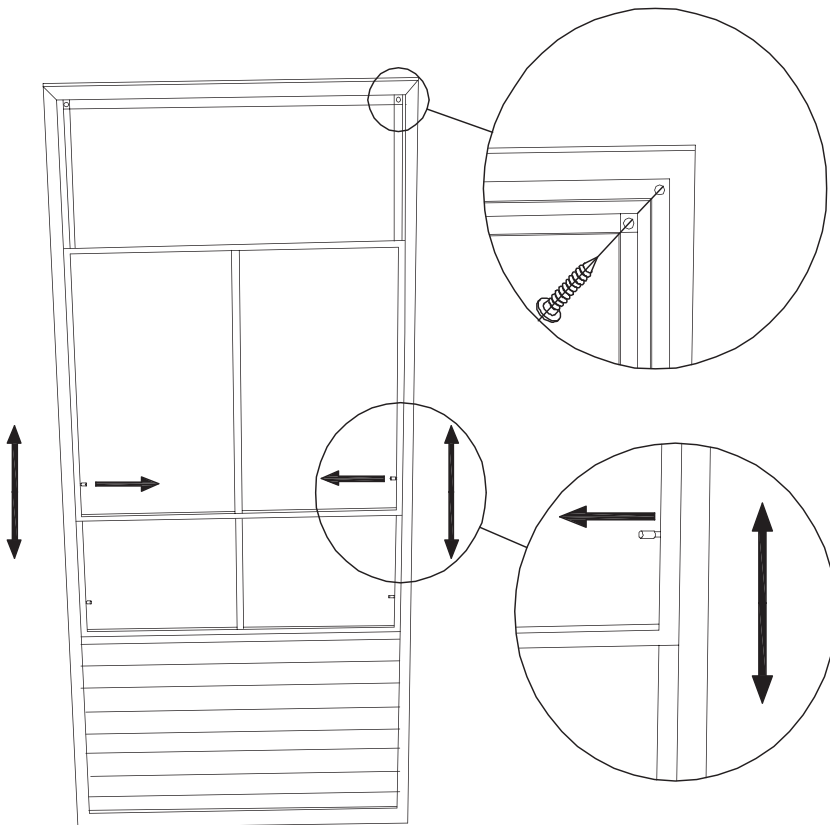

## **SPECIAL NOTES**

To remove a screen, remove the two (2) screws at the top of the frame then pull sideways to the opposite end of the handles to remove. To remove wind panels, push or pull to one side, making sure that locking pin is not locked then remove panels gently, panels are easy to remove.

### **NOTE:**

This unit is not waterproof. For best protection against rain, close the windows of each frame with the outside window in the center, and the inside window at the top.

### **CLEANING INSTRUCTIONS:**

Use only mild or warm soapy water, no strong or abrasive cleaning products. Be sure to remove heavy snow and/or ice.

### **WARNING:**

- 1) Do not use BBQ or any other flammable product inside the solarium.
- 2) **Remove snow from the roof.**

## **\*Suggestions**

The below mentioned are only suggestions in order to permit drainage, these will vary depending on your flooring – material, flatness and slope.

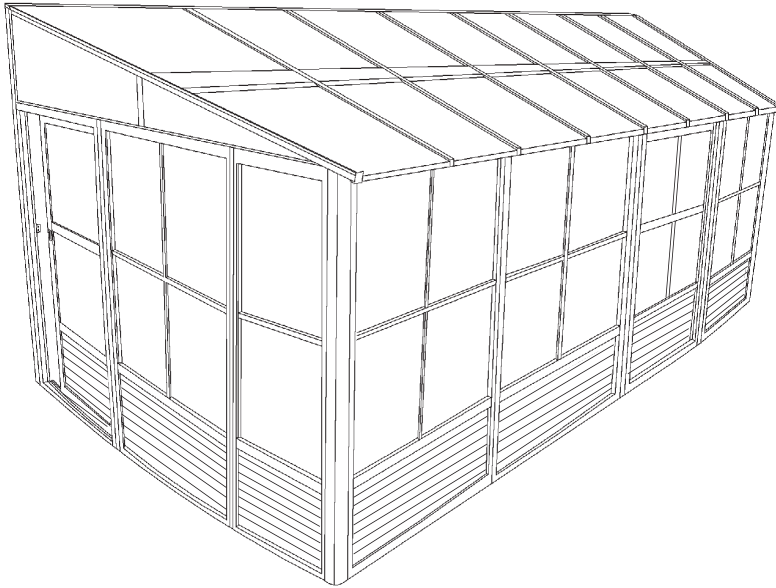

### **For Concrete Flooring**

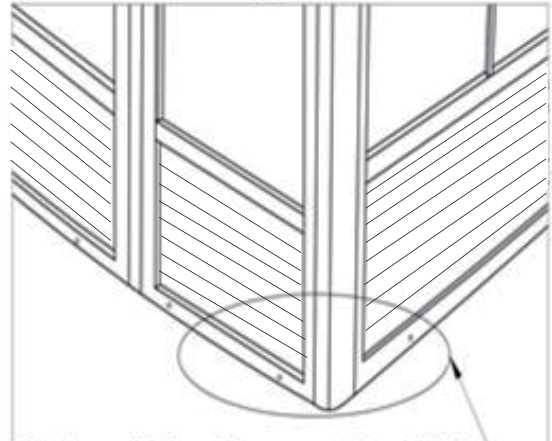

On the outside face, it is suggested to drill holes at the bottom end of the panels to permit drainage when installing on concrete floor

### **For Wooden Deck**

Drill through the wooden deck where drain holes are located to permit drainage

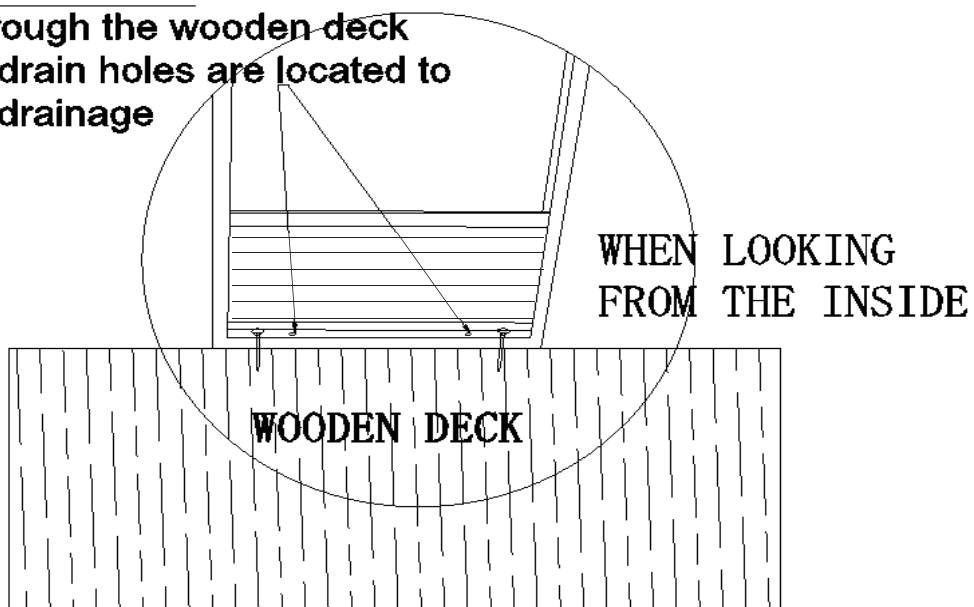

# WARRANTY

Carefully inspect the contents of the package to check if any components are missing or damaged. In the event that any parts are missing or damaged, **do not return the product to the place of purchase; instead, contact Gazebo Penguin's Customer Experience Department.**

Montreal: (514) 276-3485

Elsewhere in Canada and the United States: 1-800-737-7174

info@gazebopenguin.com

This product has been designed and manufactured to meet the highest standards of quality and durability. It is warranted against defects in material and/or workmanship as subjected in the «Warranty Limitations and exclusions» listed below:

- 1 YEAR ON MANUFACTURING DEFECTS

In the event that the product is damaged or the warranty period has expired, please contact Gazebo Penguin's Customer Experience Department for a complete list of replacement parts and prices.

## WARRANTY LIMITATIONS AND EXCLUSIONS

- 1. Uncovered Damages:** This warranty does not cover damages caused by wind, falling objects, fire, animals, vegetation, vandalism, extreme weather conditions, or collapses due to the accumulation of snow and/or ice.
- 2. Roof Maintenance:** The roof must remain free of snow and ice accumulation. Such accumulation must be removed in five-foot (5') sections from right to left. Damages resulting from lack of roof maintenance are not covered under the warranty.
- 3. Snow and Ice Removal:** Removing snow or ice from inside the product is prohibited, as it may damage the product.
- 4. Positioning:** It is advised not to place the product near buildings or trees, as snow and/or ice may slide off and accumulate on the roof, causing excessive weight.
- 5. Installation:** The warranty is valid only if the product is installed according to the instructions provided by Gazebo Penguin. Improper installation, including inadequate anchoring, voids the warranty..
- 6. Water Infiltration:** Water infiltration may occur during heavy rains. Refer to the instruction manual for window positioning and information on water drainage.
- 7. Replacement Clause:** We reserve the right to repair or replace any defective product or part at our sole discretion.
- 8. Modifications:** Any modification or addition to the product voids the warranty.