

		20'
		
		2

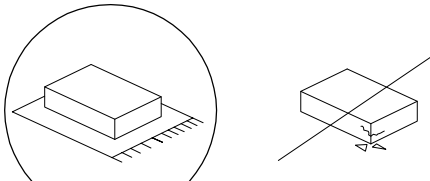

!

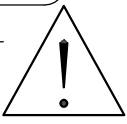
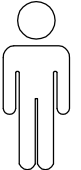
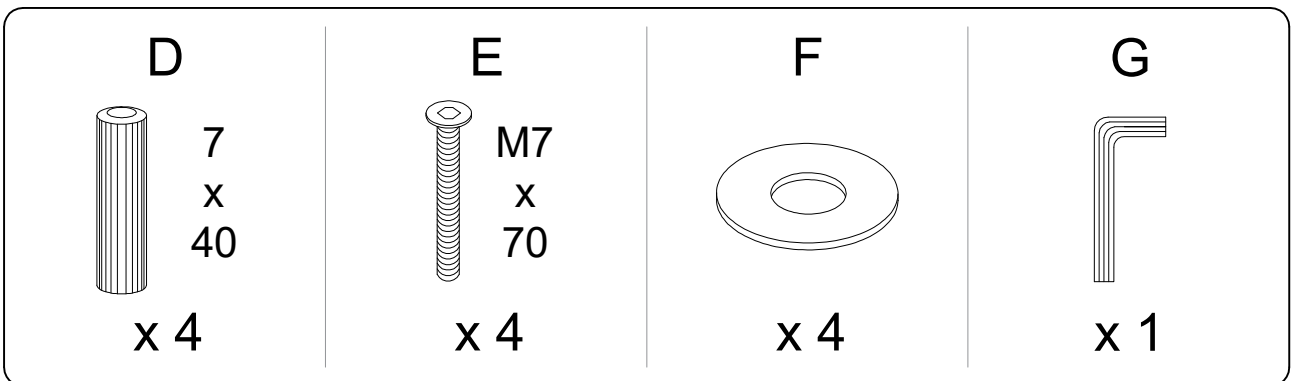
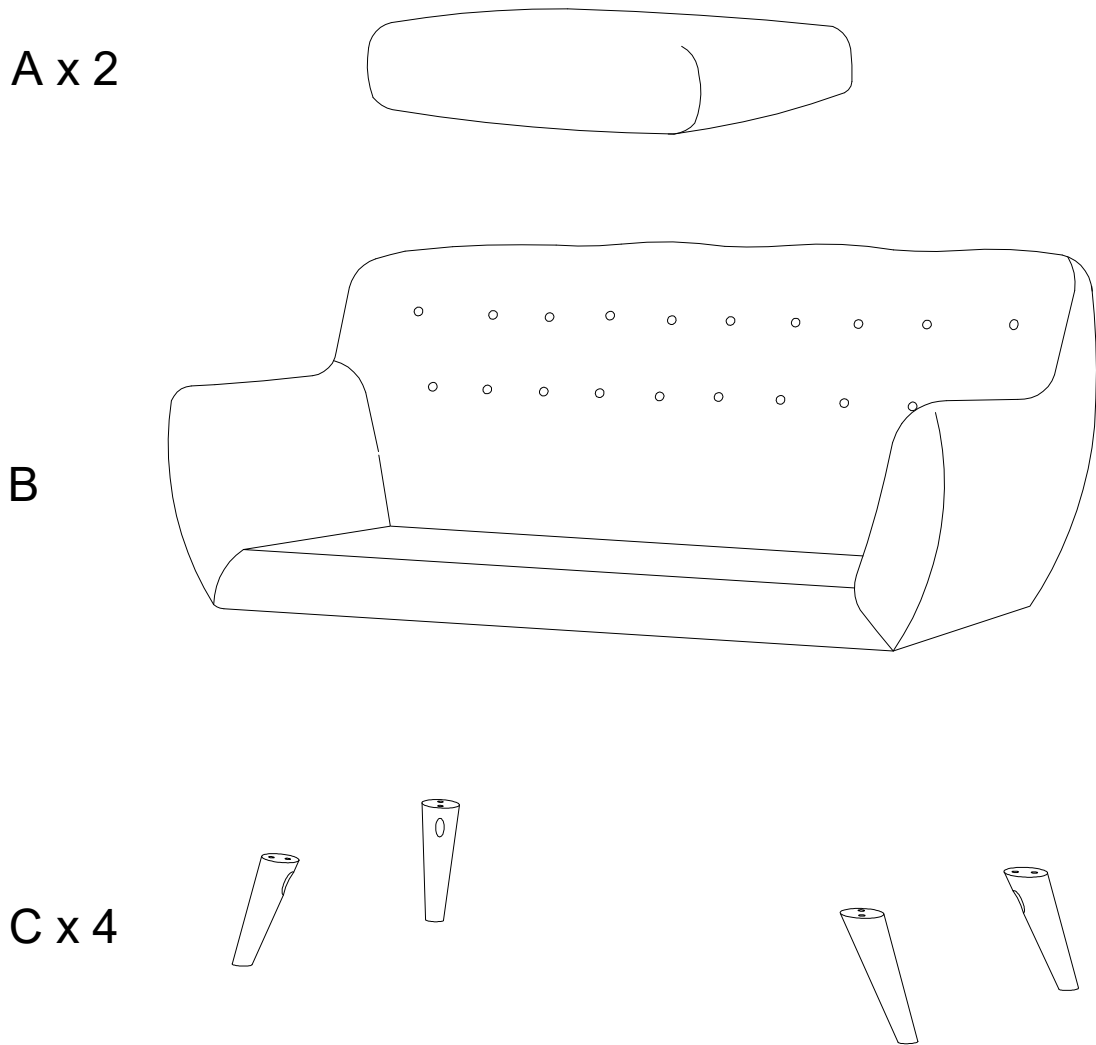
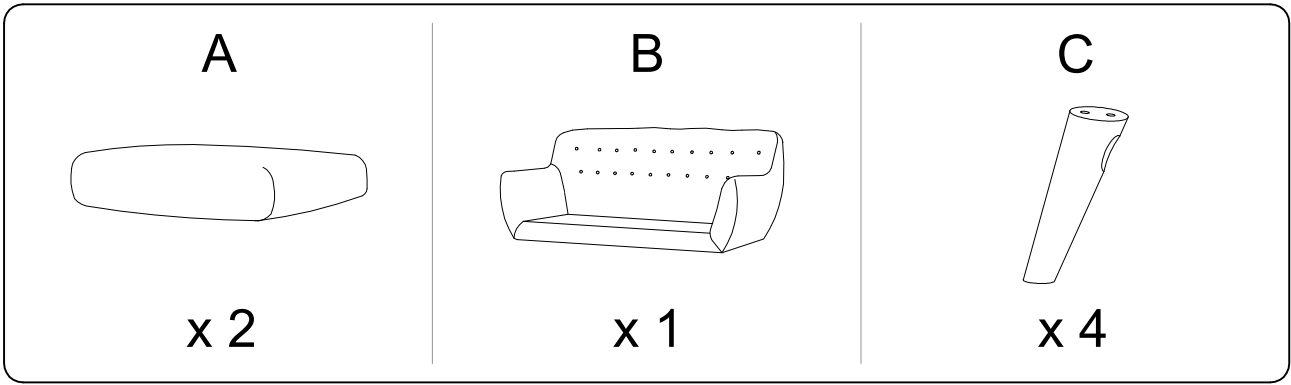
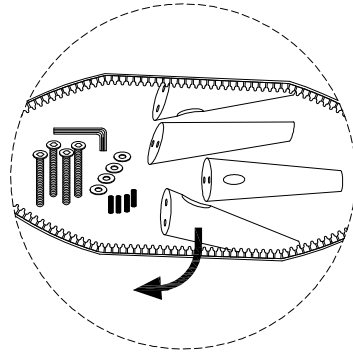
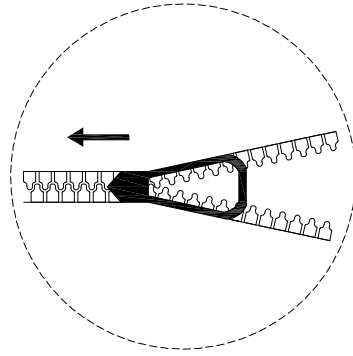
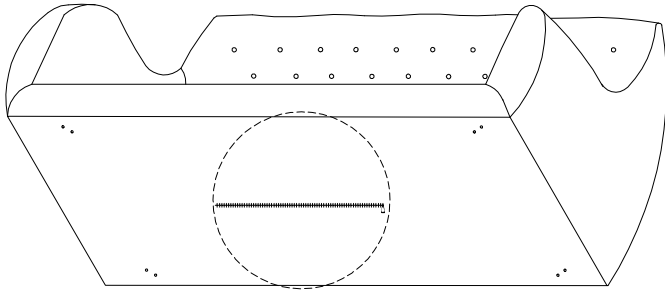

1

C



x 4

D



7
x
40

x 4

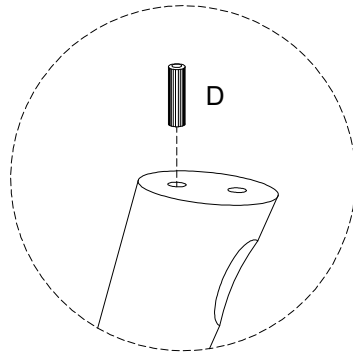
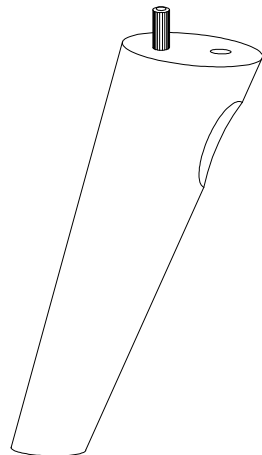

2

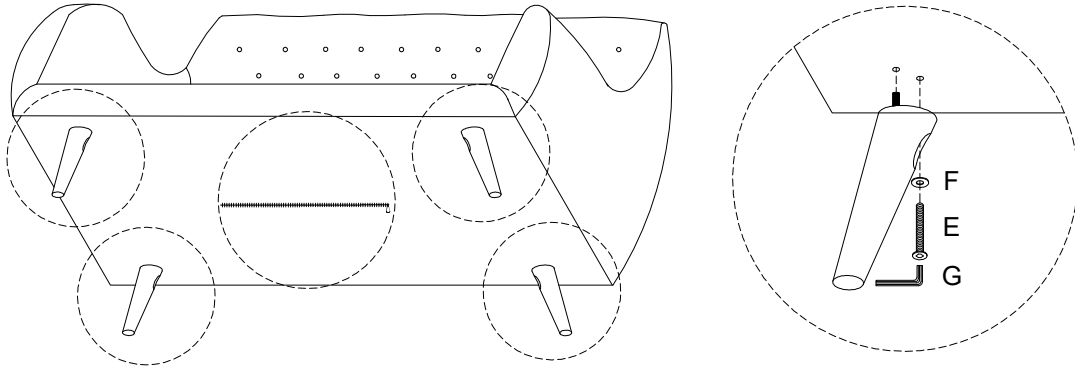
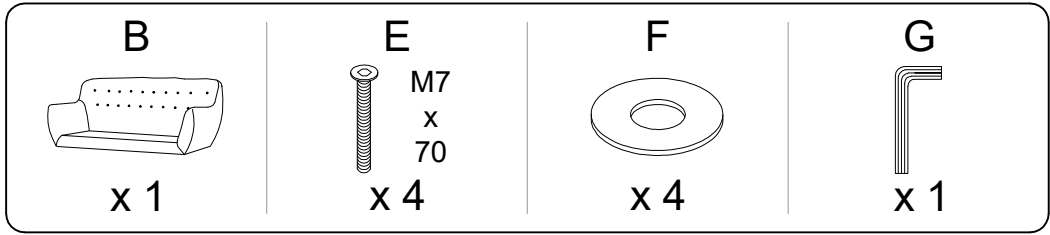

3

