









ASSEMBLY INSTRUCTIONS

Thank you for purchasing this quality product. Be sure to check all packing material carefully for small parts that may have come loose inside the carton during shipment.

Parts key			Hardware kit			
No	Qty	Description	No	Description		Qty
1	1 pc	Chair Back	A	 Hex nut	M8	6 pcs
2	1 pc	Complete Seat	B	 Lock washer	M8	14 pcs
3	1 pc	Right Facing Front Leg	C	 Flat washer	M8 x 18	14 pcs
4	1 pc	Left Facing Front Leg	D	 Long Bolt	M6 x 80	4 pcs
5	1 pc	Middle Facing Front Leg	E	 Short Bolt	M6 x 40	4 pcs
6	1 pc	Right Front Stretcher	F	 Allen Key	K4	1 pc
7	1 pc	Left Front Stretcher	G	 Key Wrench	13	1 pc
8	1 pc	Right side stretcher	H	 Screw	Ø4 x 40	10 pcs
9	1 pc	Left side stretcher	STEP 1			
10	1 pc	Middle Stretcher	- Carefully lay Chair Back flat on a smooth flat surface to prevent scratches.			
11	6 pcs	Floor Glide	- Attach Complete Seat (2) to Chair Back (1) by inserting a Flat Washer, Lock Washer and Short Bolt (E) into each of the hole on the back of the seat. Tighten screws with provided Allen Key by turning clockwise until secure. (See Detail A).			
			- Insert a Flat Washer, Lock Washer and Long Bolt (D) into each of 2 holes in the Complete Seat corners. Tighten screws with provided Allen Key. (See Detail B).			

FABRIC CARE INSTRUCTIONS REGULAR CARE

Blot gently using a clean soft damp cloth
and mild detergent DO NOT SATURATE

FABRIC CONTENT: 100% Polyester - Cleaning code W

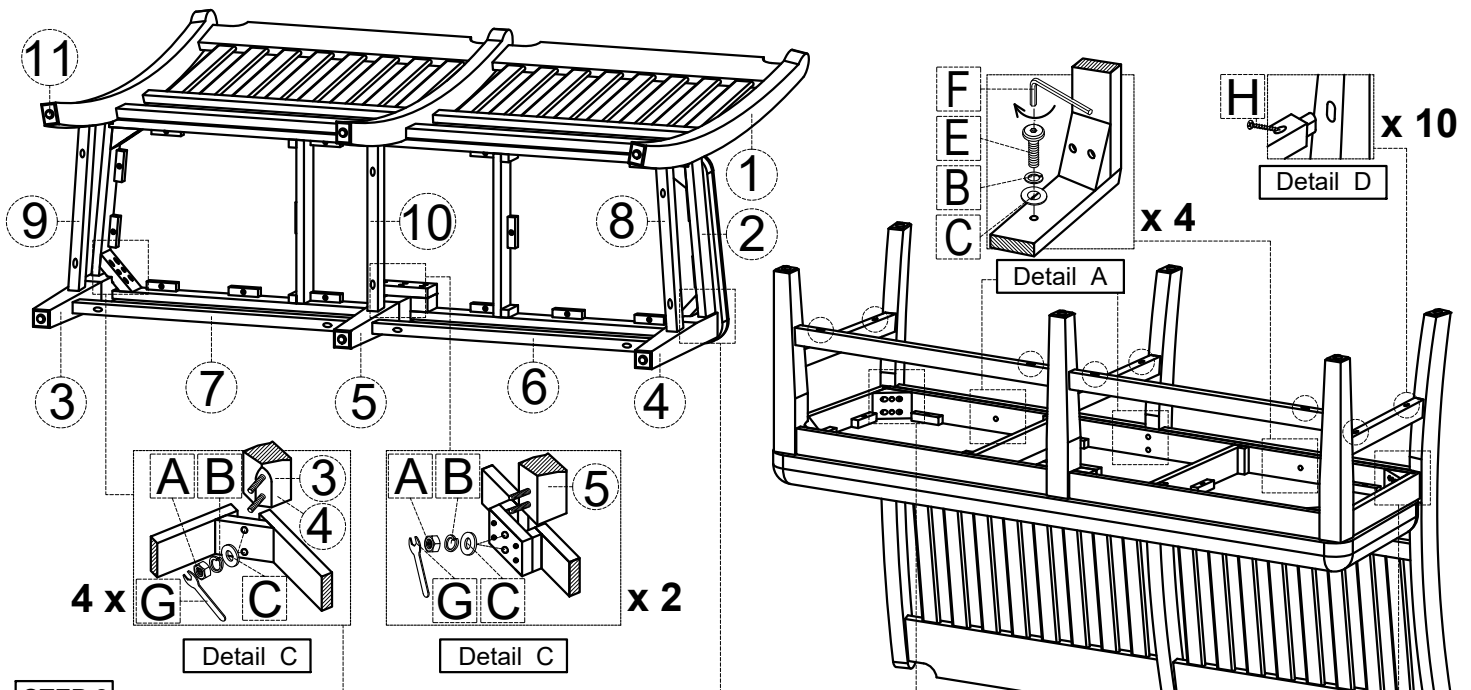

STEP 2

- Carefully turn chair upside down and attach each Corner Front Leg to the front corners of the Complete Seat (Keeping in mind of the right side and left side leg) with a Flat Washer (C), Lock Washer (B) and Nut (A). (See detail C). Keep nut loose at this point. Insert right side stretcher and left side stretcher between the Front and Back Legs.
- Position the Middle Stretcher into the Back Middle Leg, Middle Leg into place and two front stretchers between the Corner Front Legs and the Middle Leg. Secure the Middle Leg with a Flat Washer (C), Lock Washer (B) and Nut (A).
- Fasten stretchers to legs with Screws (H) using a Screwdriver (not provided).
- Be sure to level the stool prior to tightening the front leg nuts with wrench provided (G)