

Assembly | Asambla | Assemblage

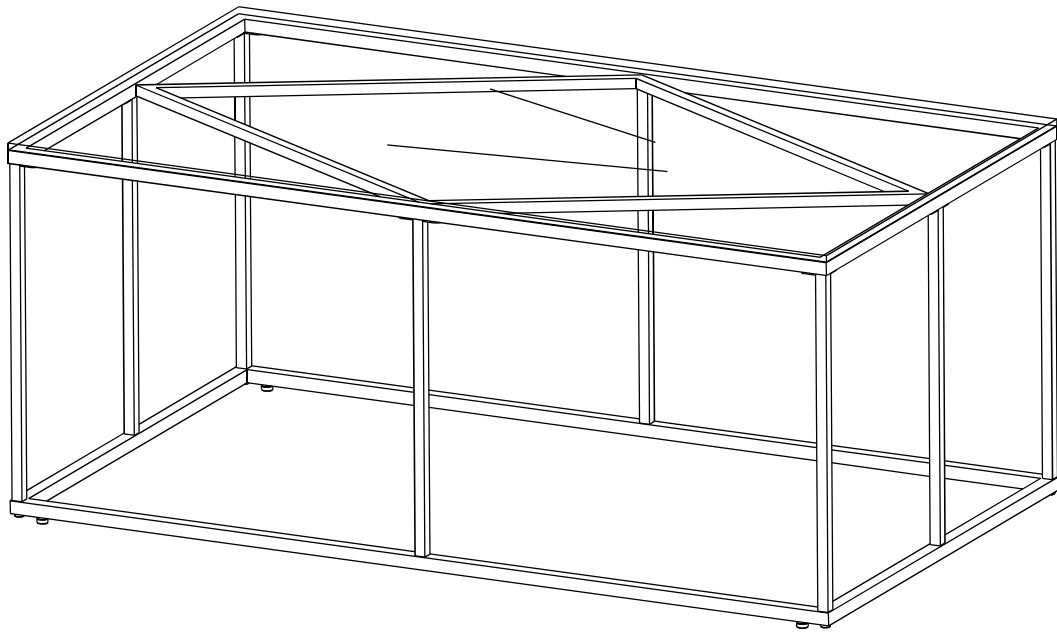

Assembly | Asamblea | Assemblage

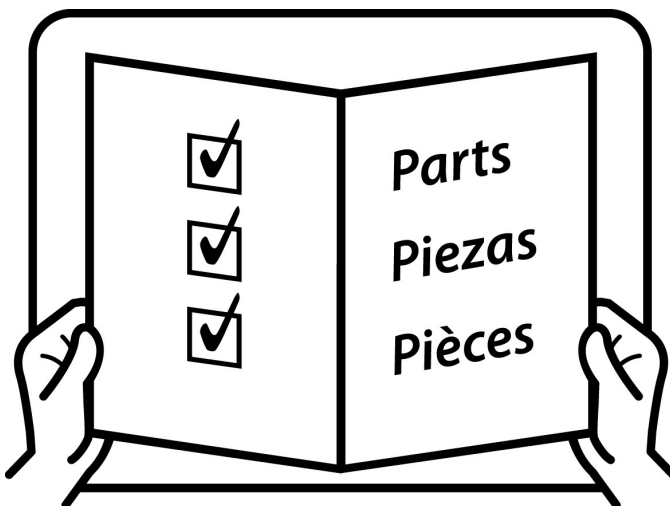
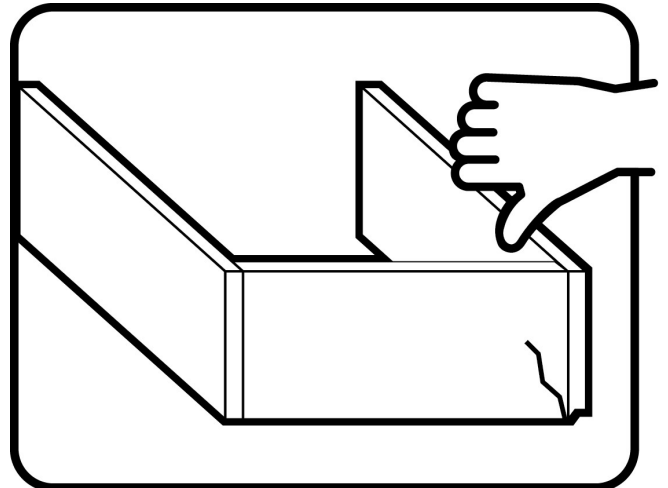
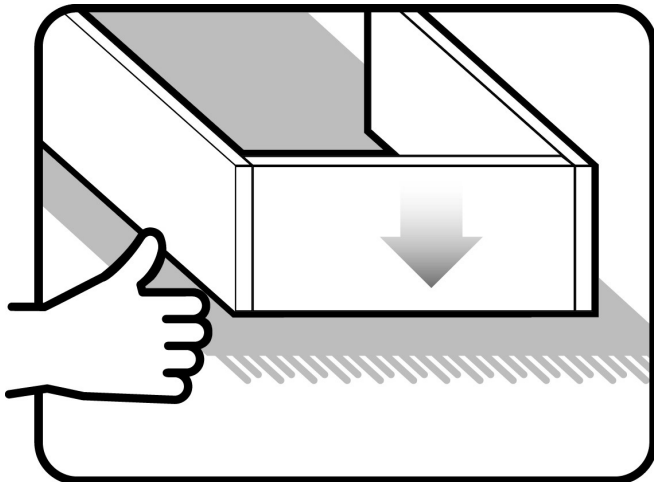
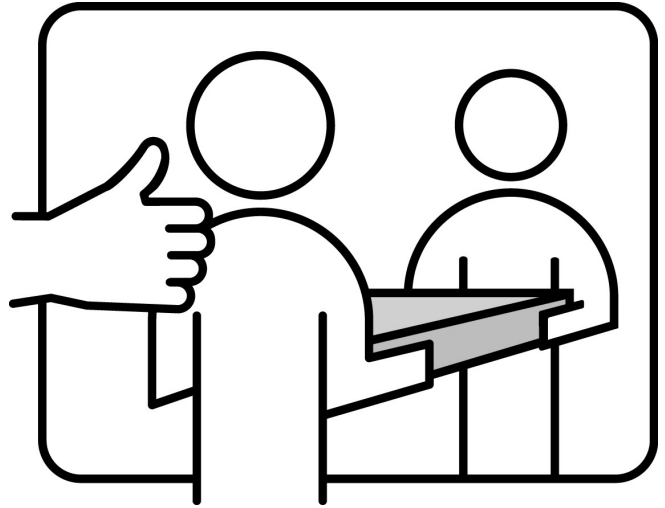
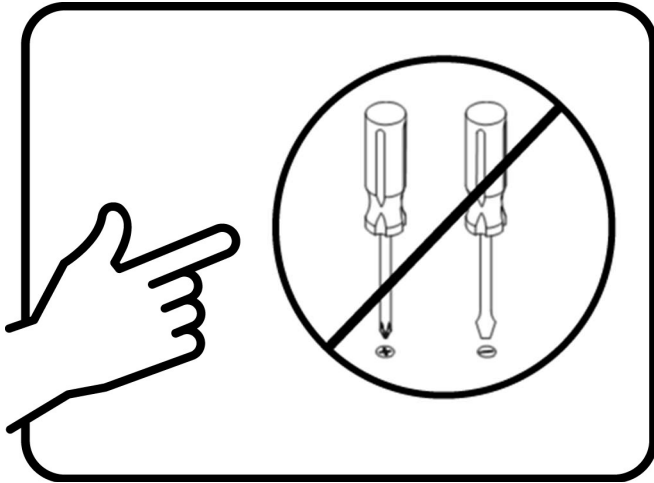

Assembly | Asamblea | Assemblage

Techniques | Técnicas | Techniques

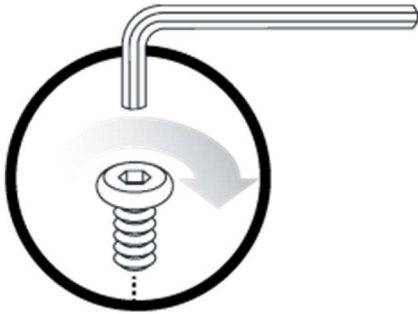

Care | Cuidado | Entretien





Safety | Seguridad | Sécurité



Note! | ¡Nota! | Remarque!

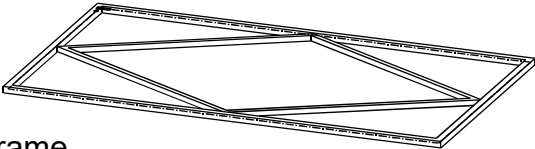
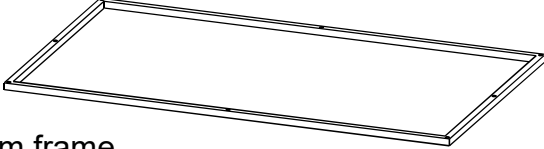
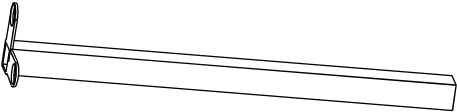
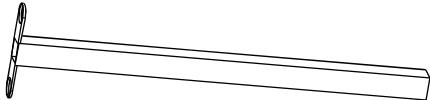
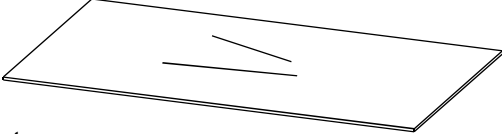
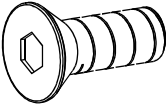
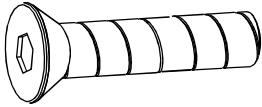
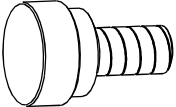

Assembly | Asamblea | Assemblage

<p>1  x1</p> <p>Top frame Marco superior Cadre supérieur</p>	<p>2  x1</p> <p>Bottom frame Marco inferior Cadre inférieur</p>
<p>3  x4</p> <p>Leg Pierna Jambe</p>	<p>4  x4</p> <p>Support Apoyo Soutien</p>
<p>5  x1</p> <p>Glass top Tapa de cristal Plateau en verre</p>	
<p>A  x16</p> <p>Bolt Tornillo Boulon 1/4"x1/2"</p>	<p>B  x8</p> <p>Bolt Tornillo Boulon 1/4"x1-1/2"</p>
<p>C  x4</p> <p>Leveler Nivelador Niveleur</p>	<p>D  x6</p> <p>Glass pad Almohadilla de vidrio Tampon de verre</p>
<p>E  x1</p> <p>Allen wrench Llave Allen Clé Allen</p>	

Note: Do not fully tighten screws until all screws are in position.



Nota: No apriete completamente los tornillos hasta que todos los tornillos estén en posición.

Remarque: Ne serrez pas complètement les vis tant que toutes les vis ne sont pas en position.

Assembly | Asambla | Assemblage

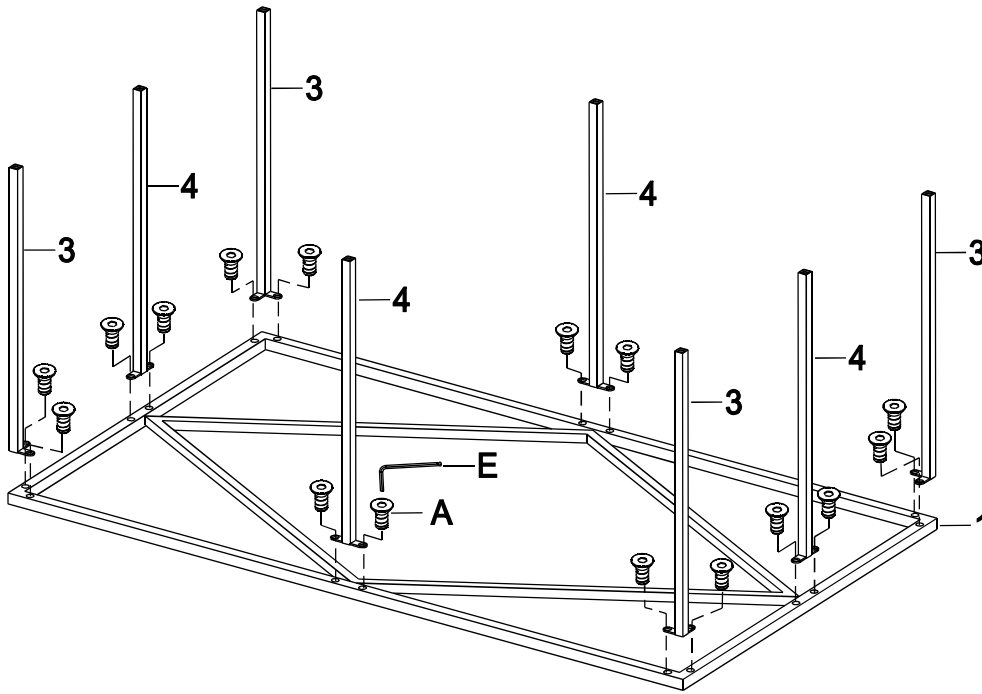

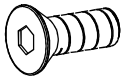
1

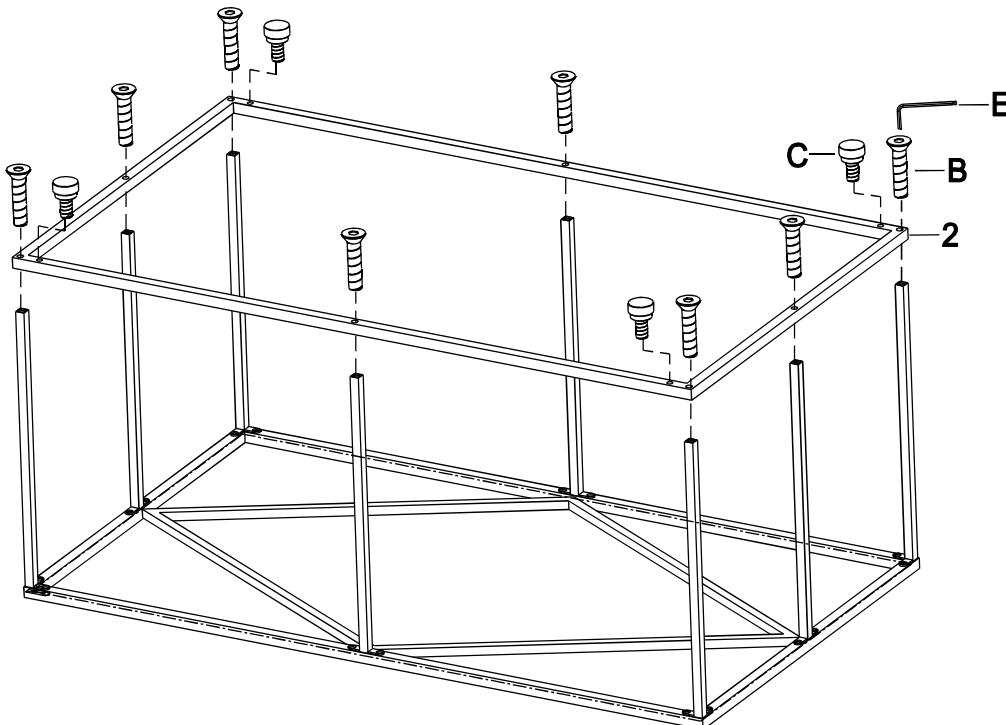

A		X16
E		X1

2

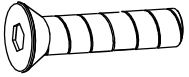
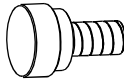

B		X8
C		X4
E		X1

Assembly | Asamblea | Assemblage

3

Tighten all screws.
Apriete todos los tornillos.
Serrer toutes les vis.

